

DETROIT DIESEL
DEMAND PERFORMANCE™



SERIES 60

The Series 60 heavy-duty diesel engine maintains fuel economy with an excellent power-to-weight ratio and unsurpassed dependability at current emission levels.

Excellent Performance and Fuel Economy

- New advanced fuel system maintains fuel economy and performance at reduced emissions
- DDEC[®] VI electronics monitor and control the engine and Aftertreatment System for peak efficiency
- Electronic VGT (Variable Geometry Turbo) provides quicker response and improved performance

Low Emissions

- Optimized Exhaust Gas Recirculation (EGR) system reduces nitrogen oxide (NOx) emissions by over 50%
- Aftertreatment System consisting of an Oxidation Catalyst and Diesel Particulate Filter reduce particulate matter emissions by 90%
- Maintenance-free crankcase breather separator

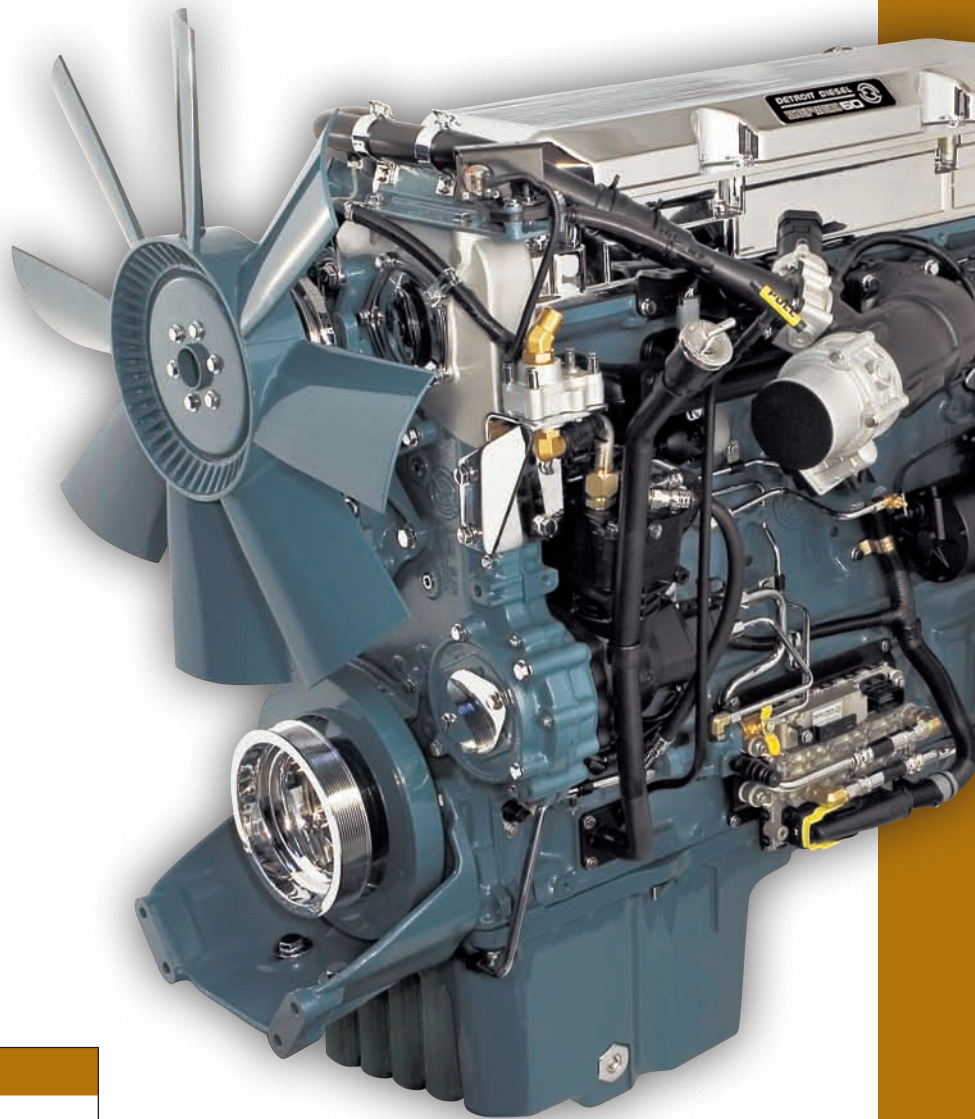

Series 60 Specifications

Configuration	Inline 6 Cylinder
Displacement	855 cu. in. (14.0 L)
Compression Ratio	17:1
Bore	5.17 in. (106 mm)
Stroke	6.61 in. (168 mm)
Weight (Dry)	2557 lb. (1273 kg)
Electronics	DDEC VI

SERIES 60 POWER RATINGS

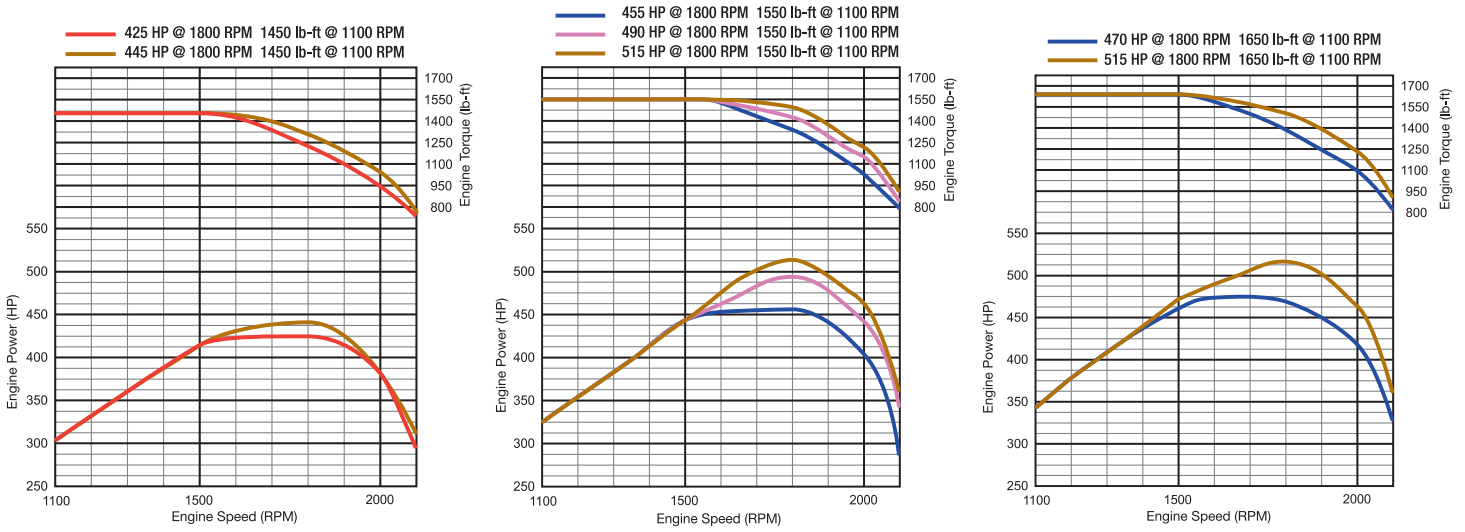

Maintenance Intervals (Miles)

Maintenance Item	Severe-Duty	Short-Haul	Long-Haul
Engine Oil and Filter Change*	15,000	20,000	30,000
Fuel Filter Change	10,000	15,000	15,000
Valve Lash Adjustment	30,000	45,000	60,000

*Based on using Detroit Diesel approved lube oil and oil analysis program.
 Severe-Duty: Less than 6,000 annual miles. Short-Haul: 6,000 to 60,000 annual miles. Long-Haul: Over 60,000 annual miles.

Cruise Power Ratings

Series 60 Engine Cruise Power Ratings	
425 / 445 HP @ 1800 RPM	1450 lb-ft @ 1100 RPM
455 / 490 HP @ 1800 RPM	1550 lb-ft @ 1100 RPM
490 / 515 HP @ 1800 RPM	1550 lb-ft @ 1100 RPM
470 / 515 HP @ 1800 RPM	1650 lb-ft @ 1100 RPM

Standard Warranty¹

Item	Warranty Limitations (Whichever Occurs First)		Repair Charge to be Paid by Owner	
	Months	Miles / Kilometers	Parts	Labor
Engine ²	0 - 24	Unlimited	No Charge	No Charge
Accessories	0 - 24	0 - 100,000 mi. 0 - 160,000 km	No Charge	No Charge
Upon expiration of the 24 month warranty coverage, but within 500,000 mi. / 800,000 km of use, the warranty continues to apply as follows:				
Major Components ³	25 - 60	0 - 500,000 mi. 0 - 800,000 km	No Charge	100% of Service Outlet's Normal Charge

¹ See your Authorized Detroit Diesel service outlet for a copy of the warranty parchment for complete details.
² Includes Jacobs Vehicle Systems braking devices, 50DN and T1 alternators, if so equipped.
³ Cylinder block/head, crankshaft, main bearing bolts, flywheel housing, connecting rod assemblies, oil cooler housing, water pump housing and air inlet housing.



For more information, call 1-800-445-1980. www.DetroitDiesel.com

DDC-EMC-FLY-0006-1207. Specifications are subject to change without notice. Detroit Diesel Corporation is registered to ISO 9001:2001. Copyright © Detroit Diesel Corporation. All rights reserved. Detroit Diesel Corporation is a Daimler company.