



AirGizmos	
GPS Panel Docks & Antenna Docks	220-222
Ameri-KING	
GPS Remote Switches/Relays	217
GPS Switching & Annunciator Panels	218
Cobham	
GPS Remote Switches/Relays	217
Deklin Technologies	
Annunciators	211
WAAS Upgrade Adapter	220
Eaton	
Switches, Pushbutton - Lighted	215-216
Switch Bulbs	216
GPS Networking	
GPS Splitters	219-220
Icarus	
Altitude Encoders/Serializers	216
Jeppesen	
Skybound Adapter	220
Mid-Continent	
Course Deviation Indicators	206
Annunciators & Annunciator Control Units	207-209
TAWS Control Units	210-211
Shadin	
Altitude Encoders/Serializers	216
Staco Switch	
Switches, Pushbutton - Lighted	211-214
Switch Bulbs	216
TED	
GPS Notch Filters	220
Trans-Cal Industries	
Interface Adapters/Serializers	217

GPS ACCESSORIES

Approach-Certified Course Deviation Indicators



MID-CONTINENT Course Deviation Indicators (TSO C60a)			Features:
Manufacturer:	Receiver:	CDI:	
AlliedSignal	KLN-88	MD40-16	T/F MSG WRN APR WPT
	KLN-89,90A	MD40-32	T/F MSG WPT
	KLN-89B,90B	MD40-232	T/F MSG WPT W/Resolver
	KLN-135	MD40-42	T/F MSG WPT
ARNAV	AVA-1000	MD40-04	T/F HI-SENS PTK WPT
	R-40,R-60	MD40-04	T/F HI-SENS PTK WPT
	FMS-5000,R-5000, R-50i	MD40-21	T/F VFR APR ALERT
	STAR 5000 GPS	MD40-27	T/F VFR APR ALERT
FOSTER	LRN-500 (orig.)	MD40-04	T/F HI-SENS WPT PTK
GARMIN	GPS-100AVD	MD40-22	T/F MSG
	GPS-150	MD40-39	T/F MSG WRN ARV
	GPS-155/165	MD40-242	T/F MSG WPT w/resolver
	GNC-300	MD40-242	T/F MSG WPT w/resolver
	GNC-250	MD40-42	T/F MSG WPT
MAGELLAN	SKYNAV 5000	MD40-31	T/F MSG WPT
NORTHSTAR	M2(GPS),600	MD40-29	T/F ALERT WRN VFR PTK
	M3	MD40-41	T/F ALERT WRN VFR PTK RAIM
	60	MD40-43	OFF PTK WRN WPT
	M3 APR	MD40-64	T/F APR PTK WPT MSG
II MORROW	Apollo 602,611,612,612B	MD40-02	T/F WRN ARV
	800 FLYBUDDY	MD40-02	T/F WRN ARV
	NMS-2001	MD40-23AL	(available thru II Morrow only)
	APOLLO 360	MD40-44	T/F MSG PTK
	2001/GPS, TSO, APR	MD40-65	T/F MSG PTK APR ACTV OBS HLD
TERRA	TPGS 400D	MD40-38	T/F WRN ADV
TRIMBLE	TNL 1000,1000DC	MD40-38	T/F WRN ADV
	TNL 2000,2000A,2100	MD40-61	T/F PTK WRN APR WPT
	TNL2100T I/O,2000T,2100T	MD40-62	T/F ADV WRN APR WPT
	TNL 2800 (system)		
	TNL 3000T,3100T	MD40-62	T/F ADV WRN APR WPT
	TNL 2000APR,2101,2101 I/O	MD40-66	T/F MSG WPT HLD APR
MISC.	VARIOUS	MD40-09	BASIC CDI



MD40-232



MD40-42



MD40-64



MD40-65



MD40-66



MD40-09

Approach certification depends on certification status of each GPS receiver. Electrical and mechanical Specifications: Size/Weight: standard 2 1/4" / 0.5 lbs. Case Material: Glass-filled, Flame-Retardant Polycarbonate. Left-Right Meter: DC Resistance: 1000 ohms + 50 ohms. Current Rating: Zero Center, 150µa,+10µa, full scale each side of center. TO-OFF-FROM Meter: DC Resistance: 200 ohms + 50 ohms. Current Rating: OFF @ Center +200 + 25µa for TO, -200 + 25µa for FROM. Annunciator Lamps: Incandescent type; operation from either 14 VDC or 28 VDC. Current Rating: 28 VDC single lamp each -37 ma; 14 VDC single lamp each -40 ma; 28 VDC double lamp (per pair) -72 ma; 14 VDC double lamp (per pair) -80 ma.

GARMIN AT Compatible 3-1/8" CDI

This CDI is the same unit that GARMIN AT™ puts in their systems. It is a direct pin-for-pin replacement for the Collins Microline™ IND-350 and 351. It is also a direct replacement for the KI-206 with a different connector. P/N: **MD200-306**

FEATURES:

- FAA TSO Approved for use with all GPS and VOR systems
- Fits standard 3-1/8" panel cutout • High quality rectilinear meter movements
- Quality MIL-SPEC connector included • Annunciations for NAV, GPS and Back course (BC)
- Automatic photocell annunciator dimming
- TSO C34e, C36e, C40c approved
- True course resolver output
- Internal 14 and 28 volt lighting
- Optional course datum synchro





MD 41 ACU TSO'd Annunciator Control Unit for Approach Certified GPS Receivers



It was merely a matter of time. Rapidly advancing technology has enabled IFR aircraft to navigate both-enroute and on approach with a single source of navigation: GPS.

But along with the enhanced capabilities in the cockpit comes increasing complexity in and behind the instrument panel. The need for a myriad of switches, relays and annunciators in approach-certified GPS-equipped aircraft makes for complex and relatively expensive installations. But no longer. The Mid-Continent Instrument's MD 41 ACU, the fully integrated, compact GPS annunciator control unit. The perfect solution.

The MD 41 combines navigation source switching to the primary CDI or HSI with key GPS selection functions in a standard AT1 panel-mount unit only 4.625 inches deep. Up to 7 separate relays and 3 switches are replaced by this single, compact unit, making installation simpler, faster and more economical. Lighted push buttons and easy-to-read annunciators make the MD 41 popular with pilots as well as technicians. Push buttons provide plenty of tactile feedback, ensuring safe, accurate operation, even in bumpy IFR conditions. And Pilots can fly with confidence, knowing that the MD 41 has been certified to TSO C129 standards, meeting the new FAA field approval requirements.

MD 41 Highlights

- TSO C129 approved to newest FAA standards
- Horizontal or vertical configuration
- Proven daylight readability
- Annunciator dim/brighten automatically
- Push-button brightness controlled by instrument lighting rheostat
- Connector/installation kit included
- 19 pole relays, gold-plated contacts
- ILS frequency override selectable
- Built-in annunciation self-test
- MD 41 ACU Controls
- NAV/GPS Alternate action switch. Selects either NAV or GPS navigational information on HSI or CDI
- GPS/APR. Momentary switch. Arms GPS Approach Mode
- OBS/LEG. Alternate action switch. Selects either OBS or LEG Mode
- Lamp Test. Momentary switch. Tests annunciator lamps

The MD 41 ACU's AT1-style footprint and 4.625-inch depth offer greater flexibility in approach-certified GPS installations. It can be a direct replacement for many DME indicators.

Environmental Characteristics:

TSO Approval: TSO C129
 Applicable Documents: RTCA DO-160C, DO-208
 Operation Temperature Range: -20°C to +70°C
 Humidity: 95%

Altitude Range: 0 to 35,000 ft.
 Vibration: Cat.M and N
 Operational Shock: Rigid Mounting, 6 G operational
 15 G Crash Safety
 All solid-state

Design:
 Power Requirements:
 MD 41-() 14VDC: 0.65 Amps
 MD 41-() 28 VDC: 0.40 Amps
 Relay Contact Current Rating: 2 Amp DC
 Available Relay Poles (SPDT): 19 Poles

Physical Characteristics:
 Mounting: Panel-mount AT1
 Width: 3.5 in.
 Height: 1.350 in.
 Depth: 4.625 in.
 Weight: 0.75 lbs.

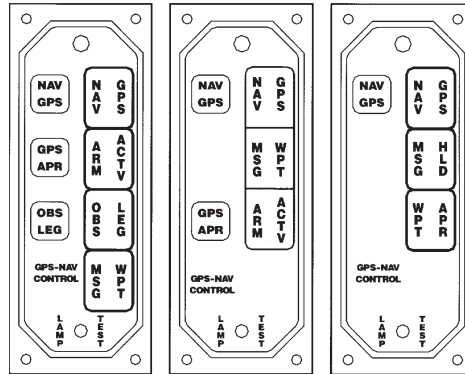

P/N: **MD41-1484W**
MD41-1488W
MD41-1494W
MD41-1498W

Description:
 ACU/Horiz/14V/GNS-43
 ACU/Horiz/28V/GNS-43
 ACU/Vertical/14V/GNS
 ACU/Vertical/28V/GNS

MD 41 Annunciator Control Unit Specifications

Vertical Mount for Flexibility

The MD 41 ACU is available in a convenient vertical mount for added installation flexibility. Also shown above are MD 41 versions for GPS systems not requiring the OBS/LEG or GPS/APR selector buttons.

Acronym Key:

ACTV	Active
ACU	Annunciator Control Unit
ARM	Arm (to make ready)
AT1	Air Transport Indicator
CDI	Course Deviation Indicator
DME	Distance Measuring Equipment
FAA	Federal Aviation Administration
GPS	Global Positioning System
HSI	Horizontal Situation Indicator
ILS	Instrument Landing System
LEG	Leg (part or section of a route)
LOC	Localizer
MSG	Message
OBS	Omni Bearing Selector
RTCA	Radio Technical Commission for Aeronautics
SPDT	Single Pole Double Throw
TSO	Technical Standard Order
VDC	Volts Direct Current
WPT	Waypoint (position or NAV fix in route)
VOR	VHF Omnidirectional Range

GPS Slim-Line Pro Annunciator Control Unit

MD41-1000 Series



- TSO C129 Approved system (DO-160C Env. Cat. F2-up to 55,000 Feet)
- Ultra-Compact design available in vertical or horizontal configuration
- 24-Pole remote relay unit with multiple mounting options
- Relays energized individually or simultaneously for flexible installation
- Aircraft Quality MIL-SPEC connectors and installation kit included
- Internally lighted push buttons
- Automatic photocell dimming for annunciators
- Proven daylight readability
- ILS frequency override selectable
- Rugged construction insures trouble free operation
- Available for all approach certified GPS systems
- Field proven installations, from single-engine to Boeing 737's
- Professional technical support

- | P/N: | Description: |
|-------------------|---|
| MD41-248 | 24 Pole Remote Relay/28 Volt |
| MD41-24P28 | 24 Pole Remote Relay/28V, 28 Volt Only PMA'D |
| MD41-1304 | Horiz/14V, RDR/TERR Switch |
| MD41-1308 | Horiz/28V, RDR/TERR Switch/PMA |
| MD41-1310 | Vert/28, Honeywell Mark VII |
| MD41-1310S | Vert/5V, Honeywell Mark VII |
| MD41-1311 | Horiz/28, Honeywell Mark VII |
| MD41-1311S | Horiz/5V |
| MD41-1314 | Vert/14V, RDR/TERR Switch |
| MD41-1318 | Vert/28V, RDR/TERR Switch |
| MD41-1324 | Horiz/14V/TSO, 24 POLE |
| MD41-1324C | Control Head Only/14V, Slim Line Pro Series |
| MD41-1328 | KLN90B S/L ACU/Horiz/28V TSO, 24 POLE |
| MD41-1328S | KLN90B S/L ACU/Horiz/5V/TSO |
| MD41-1328C | Control Head Only/28V, Slim Line Pro Series |
| MD41-1334 | KLN90B S/L ACU/VERT/14V TSO, 24 POLE |
| MD41-1334C | Control Head Only/14V, Slim Line Pro Series |
| MD41-1338 | KLN90B S/L ACU/Vert/28V TSO, 24 POLE |
| MD41-1338S | KLN90B S/L ACU/Vert/5V TSO, 24 POLE |
| MD41-1338C | Control Head Only/28V, Slim Line Pro Series |
| MD41-1348 | TAWS for MARK XXII |
| MD41-1368 | TAWS ACU/Honeywell MK21/28V |
| MD41-1368S | TAWS ACU/Honeywell MK21/5V |
| MD41-1404A | GPS400/420/430 S/L ACU Horiz/14V |
| MD41-1404C | Control Head Only/28V/Horiz, GPS400/GNC420/GPS430 |
| MD41-1408A | GPS400/420/430 S/L ACU Horiz/28V |
| MD41-1408C | Control Head Only/28V, Slim Line Pro Series |



- MD41-1414A** GPS400/GNC420 S/L ACU Vert/14V
- MD41-1418A** GPS400/GNC420 S/L ACU Vert/28V
- MD41-1424** GPS 155/165 S/L ACU Horiz/14 TSO
- MD41-1424C** Control Head Only/14V, Slim Line Pro Series
- MD41-1428** GPS 155/165 S/L ACU/Horiz/28 TSO, 24 POLE
- MD41-14285** GPS 155/165 S/L ACU/Horiz/5V TSO, 24 POLE
- MD41-1428C** Control Head Only/28V, Slim Line Pro Series
- MD41-1434** GPS 155/165 S/L ACU/Vert/14 TSO, 24 POLE
- MD41-1434C** Control Head Only/14V, Slim Line Pro Series
- MD41-1438** GPS 155/165 S/L ACU/Vert/28 TSO, 24 POLE
- MD41-14385** GPS 155/165 S/L ACU/Vert/5V TSO, 24 POLE
- MD41-1444** Horiz/14V/TSO, GNC300, 300XL/155XL/165XL
- MD41-1444C** Control Head Only/14V, Slim Line Pro Series
- MD41-1448** Horiz/28V/TSO, GNC300, 300XL/155XL/165XL
- MD41-14485** Horiz/5V/TSO, GNC300, 300XL/155XL/165XL
- MD41-1448C** Control Head Only/28V, Slim Line Pro Series
- MD41-1454** Vert/14V/TSO, GNC300, 300XL/155XL/165XL
- MD41-1454C** Control Head Only/14V, Slim Line Pro Series
- MD41-14585** Vert/5V/TSO, GNC300, 300XL, 155XL/165XL
- MD41-1464A** Horiz/14V/TSO/GARM 530, GARMIN 530/GNS-530
- MD41-14685** Horiz/5V/TSO, FOR GNS-430
- MD41-1468A** Horiz/28V/TSO/GARM 530, GARMIN 530/GNS-530
- MD41-1470** OBS Switch Only for GARMIN GNS 430/530
- MD41-1474A** Vert/14V/TSO for GARMIN GNS-430
- MD41-1478A** Vert/28V/TSO for GARMIN GNS-430
- MD41-1484W** Horiz/14V/GNS-430W/530W WAAS Annunciator
- MD41-1488W** 28V/GNS-430W/530W WAAS Annunciator
- MD41-1494W** Vert/14V/GNS-430W, 530W WAAS Annunciator
- MD41-1498W** Vert/28V/GNS-430W, 530W WAAS Annunciator

MD41-1500, 1600 Series

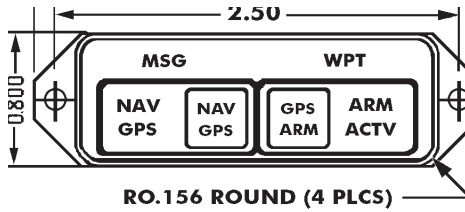

1/2 ATI HOLE PUNCH

Great for cutting holes for the Mid-Continent MD-41 GPS Interface, the Shadin MiniFlo Fuel Indicator and a host of other products that use a 3.195 x 1.22 inch cut out. P/N: **MD155**

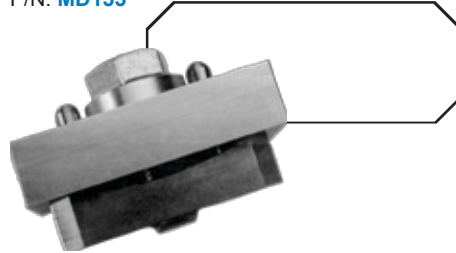

File Templates For MD41 GPS (ACU's)

Available in three sizes:

- P/N: **MD-100** Description: For standard 3.2 x 1.2 inch ACU
- MD-1000S** For 2.25 x 0.8 inch "Slim Line"
- MD-1000L** For 2.73 x 0.8 inch "Slim Line"

- Rugged .04 inch thick stainless steel plate
- Use as template when cutting & filing mounting holes for MD41 ACU's.

MD41-1300, 1400 Series



MD41-1300, 1400 Series

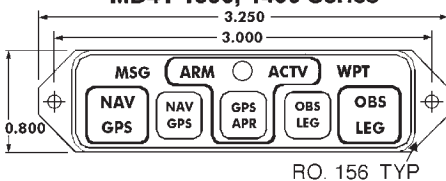

Annunciation Options for GARMIN



Garmin mandates installation of an alternate annunciator for any WAAS installation when internal annunciation is outside the "acceptable field-of-view".

EDMO sells all three of the annunciation options that Garmin offers, the MD41-1468A, the MD41-1408A and the MD41-1488W. Refer to the Garmin install manual for details.



MD41-1408A



MD41-1488W



MD41-1468A

- P/N: **MD41-1488W** DESCRIPTION: WAAS ANNUNCIATOR, ACU/HORIZ/28V/GNS-430 W/530W
- MD41-1468A** S/L ACU/HORIZ/28V/TSO/ GARM 530
- MD41-1408A** GPS400/420/430 S/L ACU HOR/28V

GPS Slim-Line Pro Annunciator Control Units

Manufacturer Allied Signal

Description:

KLN-89B- HOR, 14V (HEAD ONLY)
KLN-89B- HOR, 14V (WITH REMOTE RELAY)
KLN-89B- HOR, 28V (HEAD ONLY)
KLN-89B- HOR, 28V (WITH INTERNAL RELAYS)
KLN-89B- HOR, 28V (WITH REMOTE RELAY)
KLN-89B- VERT, 14V (HEAD ONLY)
KLN-89B- VERT, 14V (WITH INTERNAL RELAYS)
KLN-89B- VERT, 14V (WITH REMOTE RELAY)
KLN-89B- VERT, 28V (HEAD ONLY)
KLN-89B- VERT, 28V (WITH INTERNAL RELAYS)
KLN-89B- VERT, 28V (WITH REMOTE RELAY)
KLN-900- HOR, 28V (HEAD ONLY)
KLN-900- HOR, 28V (WITH INTERNAL RELAYS)
KLN-900- HOR, 28V (WITH REMOTE RELAY)
KLN-900- VERT, 28V (HEAD ONLY)
KLN-900- VERT, 28V (WITH INTERNAL RELAYS)
KLN-900- VERT, 28V (WITH REMOTE RELAY)
KLN-90B- HOR, 14V (WITH INTERNAL RELAYS)
KLN-90B- HOR, 14V (WITH REMOTE RELAY)
KLN-90B- HOR, 28V (HEAD ONLY)
KLN-90B- HOR, 28V (WITH INTERNAL RELAYS)
KLN-90B- HOR, 28V (WITH REMOTE RELAY)
KLN-90B- VERT, 14V (HEAD ONLY)
KLN-90B- VERT, 14V (WITH INTERNAL RELAYS)
KLN-90B- VERT, 14V (WITH REMOTE RELAY)
KLN-90B- VERT, 28V (HEAD ONLY)
KLN-90B- VERT, 28V (WITH INTERNAL RELAYS)
KLN-90B- VERT, 28V (WITH REMOTE RELAY)
KLN-90B- VERT, 28V (WITH INTERNAL RELAYS)
KLN-90B- VERT, 28V (WITH REMOTE RELAY)
KLN-90B- VERT, 28V (WITH INTERNAL RELAYS)
KLN-90B- HOR, 14V (HEAD ONLY)
ALWAYS SPECIFY VOLTAGE (5 Volt Available)

Manufacturer Garmin

Description:

GNS-430- HOR, 14V (HEAD ONLY)
GNS-430- HOR, 28V (HEAD ONLY)
GNS-430- VERT, 14V (HEAD ONLY)
GNS-430- VERT, 28V (HEAD ONLY)
GPS155/165- HOR, 14V (HEAD ONLY)
GPS155/165- HOR, 14V (WITH REMOTE RELAY)
GPS155/165- HOR, 28V (HEAD ONLY)
GPS155/165- HOR, 28V (WITH REMOTE RELAY)
GPS155/165- VERT, 14V (HEAD ONLY)
GPS155/165- VERT, 14V (WITH REMOTE RELAY)
GPS155/165- VERT, 28V (HEAD ONLY)
GPS155/165- VERT, 28V (WITH REMOTE RELAY)
GPS155XL/GNC300(XL)- HOR, 14V (HEAD ONLY)
GPS155XL/GNC300(XL)- HOR, 14V (WITH REMOTE RELAY)
GPS155XL/GNC300(XL)- HOR, 28V (HEAD ONLY)
GPS155XL/GNC300(XL)- HOR, 28V (WITH REMOTE RELAY)
GPS155XL/GNC300(XL)- VERT, 14V (HEAD ONLY)
GPS155XL/GNC300(XL)- VERT, 14V (WITH REMOTE RELAY)
GPS-400, GNC-420, GNS-430- HOR, 14V (HEAD ONLY)
GPS-400, GNC-420, GNS-430- HOR, 14V
(W/ REMOTE RELAY)
GPS-400, GNC-420, GNS-430- HOR, 28V (HEAD ONLY)
GPS-400, GNC-420, GNS-430- HOR, 28V
(W/ REMOTE RELAY)
GPS-400, GNC-420, GNS-430- VERT, 14V (HEAD ONLY)
GPS-400, GNC-420, GNS-430- VERT, 14V
(W/ REMOTE RELAY)
GPS-400, GNC-420, GNS-430- VERT, 28V (HEAD ONLY)
GPS-400, GNC-420, GNS-430- VERT, 28V
(W/ REMOTE RELAY)
S/L ACU/HORIZ/14V/TSO GARMIN 530
S/L ACU/HORIZ/28V/TSO/GARMIN 530
S/L ACU/VERT/14V/TSO
S/L ACU/VERT/28V/TSO
ALWAYS SPECIFY VOLTAGE (5 Volt available)

Manufacturer II Morrow/UPS Aviation Technologies

Description:

GX50/60, 2001()/2101- HOR, 14V (HEAD ONLY)
GX50/60, 2001()/2101- HOR, 14V (WITH INTERNAL RELAYS)
GX50/60, 2001()/2101- HOR, 14V (WITH REMOTE RELAY)
GX50/60, 2001()/2101- VERT, 14V (HEAD ONLY)
GX50/60, 2001()/2101- VERT, 14V (WITH REMOTE RELAY)
GX50/60, 2001()/2101- VERT, 28V (WITH INTERNAL RELAYS)
GX50/60, 2001()/2101- VERT, 28V (WITH REMOTE RELAY)
GX50/60, 2001()/2101-VERT, 14V (WITH INTERNAL RELAYS)
GX50/60, 2001()/2101-VERT, 28V (HEAD ONLY)

ACU:

MD41-1524C
MD41-1524
MD41-1528C
MD41-528
MD41-1528
MD41-1534C
MD41-534
MD41-1534
MD41-1538C
MD41-538
MD41-1538
MD41-1928C
MD41-928
MD41-1928
MD41-1938C
MD41-938
MD41-1938
MD41-324
MD41-1324
MD41-1328C
MD41-328
MD41-1328
MD41-1334C
MD41-334
MD41-1334
MD41-1338C
MD41-338
MD41-1338
MD41-1324C

ACU:

MD41-1464C
MD41-1468C
MD41-1474C
MD41-1478C
MD41-1424C
MD41-1424
MD41-1428C
MD41-1428
MD41-1434C
MD41-1434
MD41-1438C
MD41-1438
MD41-1444C
MD41-1444
MD41-1448C
MD41-1448
MD41-1454C
MD41-1454
MD41-1404C
MD41-1404A
MD41-1408C
MD41-1408A
MD41-1414C
MD41-1414A
MD41-1418C
MD41-1418A
MD41-1464A
MD41-1468A
MD41-1474A
MD41-1478A

ACU:

MD41-1724C
MD41-724
MD41-1724
MD41-1734C
MD41-1734
MD41-738
MD41-1738
MD41-734
MD41-1738C

Manufacturer Northstar

Description:

M-3APR- HOR, 14V (HEAD ONLY)
M-3APR- HOR, 14V (WITH INTERNAL RELAYS)
M-3APR- HOR, 14V (WITH REMOTE RELAY)
M-3APR- HOR, 28V (HEAD ONLY)
M-3APR- HOR, 28V (WITH INTERNAL RELAYS)
M-3APR- HOR, 28V (WITH REMOTE RELAY)
M-3APR- VERT, 14V (HEAD ONLY)
M-3APR- VERT, 14V (WITH INTERNAL RELAYS)
M-3APR- VERT, 14V (WITH REMOTE RELAY)
M-3APR- VERT, 28V (HEAD ONLY)
M-3APR- VERT, 28V (REMOTEL RELAY)
M-3APR- VERT, 28V (WITH INTERNAL RELAYS)
ALWAYS SPECIFY VOLTAGE

ACU:

MD41-1824C
MD41-824
MD41-1824
MD41-1828C
MD41-828
MD41-1828
MD41-1834C
MD41-834
MD41-1834
MD41-1838C
MD41-1838
MD41-838

Manufacturer Trimble

Description:

2000APR, 2101(ALL)- HOR, 14V (HEAD ONLY)
2000APR, 2101(ALL)- HOR, 14V (WITH INTERNAL RELAYS)
2000APR, 2101(ALL)- HOR, 14V (WITH REMOTE RELAY)
2000APR, 2101(ALL)- HOR, 28V (HEAD ONLY)
2000APR, 2101(ALL)- HOR, 28V (WITH REMOTE RELAY)
2000APR, 2101(ALL)- VERT, 14V (HEAD ONLY)
2000APR, 2101(ALL)- VERT, 14V (WITH INTERNAL RELAYS)
2000APR, 2101(ALL)- VERT, 14V (WITH REMOTE RELAY)
2000APR, 2101(ALL)- VERT, 28V (HEAD ONLY)
2000APR, 2101(ALL)- VERT, 28V (WITH INTERNAL RELAYS)
2000APR, 2101(ALL)- VERT, 28V (WITH REMOTE RELAY)
TNL8100,HT9000- HOR, 28V (HEAD ONLY)
TNL8100,HT9000- HOR, 28V (WITH REMOTE RELAY)
TNL8100,HT9000- VERT, 28V (HEAD ONLY)

ACU:

MD41-1624C
MD41-624
MD41-1624
MD41-628
MD41-1628
MD41-1634C
MD41-634
MD41-1634
MD41-1638C
MD41-638
MD41-1638
MD41-1648C
MD41-1648
MD41-1658C



MD41-248 24-Pole Remote Relay Unit

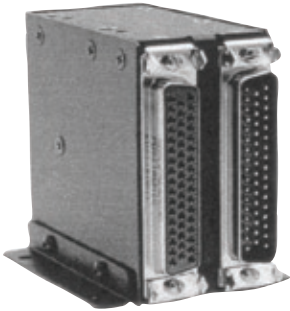

MD41-24P14V
MD41-24P28V

24 Pole Remote Relay Unit

PMA'd

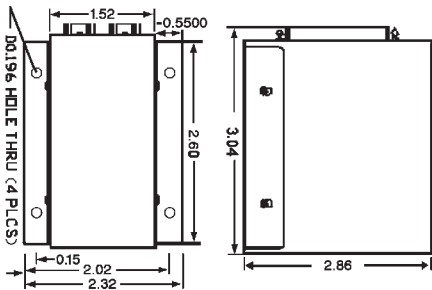
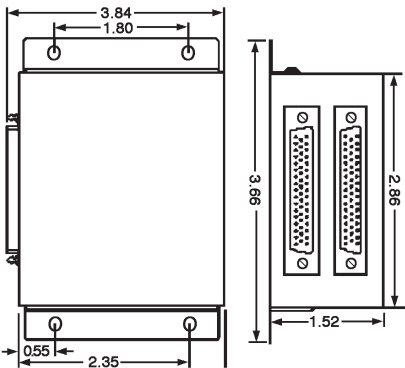

TAWS Control Units (TACU)



P/N: MD41-1208



P/N: MD41-1308

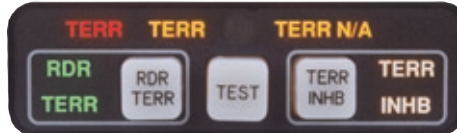

Mid-Continent Instruments' MD41 Terrain Awareness Control Units (TACU). These units provide annunciation and mode selection for both TAWS (Terrain Awareness Warning System) and EGPWS (Enhanced Ground Proximity Warning System). The fully integrated, compact control units do away with the need for a myriad of switches, relays and annunciators making installation fast and easy. Both the MD41-1308 and the more compact MD41-1208 present primary or secondary visual alert of TAWS/EGPWS within the pilot's direct field-of-view. Engineered with a single cutout, easy-to-wire D-subminiature connector, and internal dimming circuitry, the TACU reduces typical installation costs.

P/N: MD41-1208 Description: Works with the HONEYWELL KGP-560. It has 2 BUTTONS and shows no "TAWS" display on the radar, HORIZ/28V

- MD41-1208 HORIZ/28V
- MD41-1204 HORIZ/14V
- MD41-12085 HORIZ/5V
- MD41-1214 VERT/14V
- MD41-1218 VERT/28V
- MD41-12185 VERT/5V
- MD41-1308 EGPWS, 28V

Compact Self-Contained Annunciation & Control Unit

The MD41-1024, -1034, -1028, -1038 is a compact, self-contained Annunciation and Control unit. The fully integrated, control unit provides annunciation and mode selection for TAWS (Terrain Awareness Warning System). It combines all the necessary functions required to interface a wide range of TAWS systems for FAA approval.

Other features include dual 20,000 hour lamps used for all annunciations, internally lighted selection switches and choice of manual or automatic photocell dimming. An external annunciation dimming adjustment is provided for balancing low level light conditions.

- P/N: MD41-1024 Description: HORIZ/14V
- MD41-1028 HORIZ/28V
- MD41-1034 VERT/14V
- MD41-1038 VERT/28V

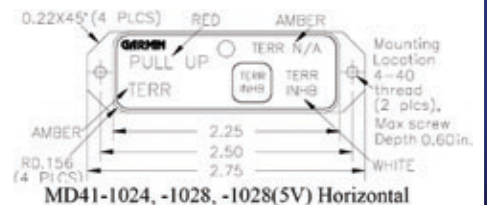
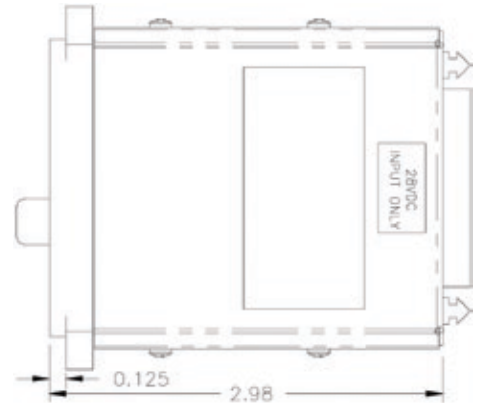



TAWS/ACU/ HORIZONTAL/5V

The MD41-1244, -1254, -1248, -1258 is a compact, self-contained Annunciation and Control unit. The fully integrated, control unit provides annunciation and mode selection for the Sandel ST3400 TAWS (Terrain Awareness Warning System). Other features include dual 20,000 hour lamps used for all annunciations, internally lighted selection switches and choice of manual or automatic photocell dimming. An external annunciation dimming adjustment is provided for balancing low level light conditions.

P/N: **MD41-12485**

TAWS/EGPWS CONTROL UNIT/VER/5V

P/N: **MD41-13105**

TAWS ACU/HONEYWELL MK21/5V

MD41-1300 Series Terrain Awareness Annunciation Control Unit for the Honeywell Mark XXI EGPWS System

P/N: **MD41-13685**

TAWS ACU/HONEYWELL MK21/5V

MD41-1300 Series Terrain Awareness Annunciation Control Unit for the Honeywell Mark XXI EGPWS System

P/N: **MD41-13685**



Deklin Technologies

GPS ANNUNCIATOR

GPS Annunciator.

- Smallest - Lightest - Easiest
- 2.50" w X 0.63" h X 0.20" Thick
- Only 3 Holes to Drill
- Reduced Installation Time
- DO160E Tested

P/N: **DWA1000**

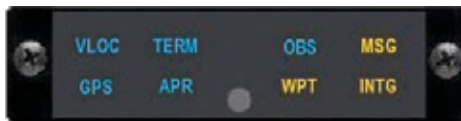

STACO High Bright White LED/Voltage-Dimmed LED

OVERVIEW:

The StacoSwitch Series 90 is a broad product line of rugged duty lighted pushbutton switches and indicators...and they have expanded it further. The popular Series 90 incandescent and LED lighted displays are now available with the new High Brightness White LED circuit and voltage-dimming capabilities.

MARKETS:

The Series 90 is built to rugged Military Specifications and is used throughout the world in applications where extreme environments demand the ultimate in switch performance. It has found use in all branches of the military, commercial aircraft and avionics, and industrial markets.

APPLICATIONS:

StacoSwitch offers numerous lighted display styles, including Sunlight Readable and Night Vision Compatible in both incandescent and LED versions. Staco's newest voltage-dimmed High Bright White LED version can be used along with existing incandescent without changing your dimming circuit. The transistorized voltage-dimming circuit is packaged as Chip Scale Package (CSP) device and incorporated in the High Brightness White LED light source assembly. Voltage dimming operates from 28 V down to 8.4 V.



What ever your lighted switch/indicator needs may be, StacoSwitch has a solution.

RETROFIT OPTION:

For those current users of Series 90 incandescent lighted pushbuttons, StacoSwitch offers a replacement LED light source assembly. The voltage-dimmed LED assembly is a drop-in replacement for incandescent pushbuttons in the Series 90 switch body, allowing users to eliminate costly replacement of incandescent lamps with long life LEDs. LED life is rated up to 100,000 hours or longer.

Users simply remove the incandescent lamps, slide off the base, and replace it with the new LED light source assembly. This is available in both High Bright LED and voltage-dimmed High Bright LED.

FEATURES GENERAL:

- Color is pure white, not the "yellowish" white of incandescent bulbs.
 - Brightness is approximately equal in brightness to incandescent lighting.
 - Maximum current for a pushbutton is 90-180 mA @ 5 V and 40-80 mA @ 28 V (depending on configuration) for maximum brightness and long life.
 - White LED lighting is compatible with SLR and NVIS requirements, as well as most standard color options and display styles.
- Note: Dimming curve of standard LED will be different than an incandescent voltage-dimming curve.

VOLTAGE-DIMMABLE WHITE LED OPTION:

- Voltage-dimming curve simulates 28 V incandescent lighting curves.
- Operating voltage range for the 28V voltage dimmable unit is approx 8.4V to 28V.
- Dimming curve simulates incandescent light output on the same circuit
- Single IC chip dimer design allows for direct replacement of incandescent pushbuttons in Series 90 switches on a voltage-dimmed circuit with the voltage-dimmable white LED display.
- Single IC chip dimmer with matched white LED circuit can be adapted to other applications utilizing 28V dimming circuits. Call EDMO Sales for application assistance. 1-800-235-3300

Current (mA)	White LED Power Requirements		
	Full or 2-Way Split	3-Way Split	4-Way Split
5 volt	90	135	180
28 volt	40	60	80
28 volt dimmable	80	80	80

- Drop-in replacement for current incandescent pushbuttons
- Bright white lighting uses less power
- Removable LED base is easily replaced
- Voltage-dimmed version can be mixed with incandescent lighting on the same voltage-dimmed bus
- Efficient manufacturing design makes LED lighting affordable

High Brightness LED Voltage Dimming Curve with CSP Device

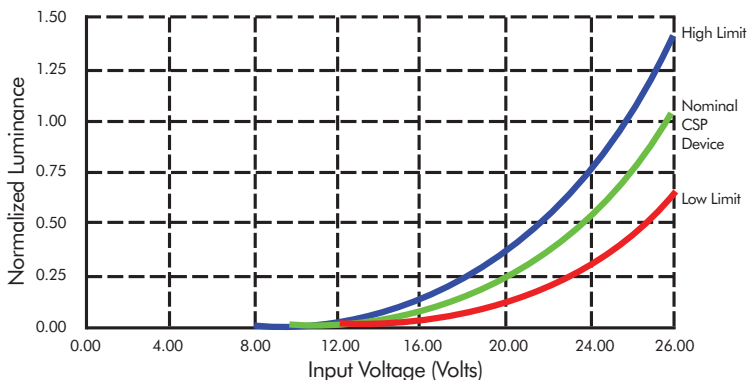

SPECIFICATIONS:

Part Number Ordering LED Light Source, Ground Circuit Options & EMI/RFI Status

The Table below is part of StacoSwitch's Series 90 Part Conflagration, Table 4 Addendum. Please refer to the Series 90 Catalog for additional switch and pushbutton options.

CODE:	LIGHT SOURCE: CONFIGURATION	BUSSED GROUND SHIELDED	EMI/RFI OR SINKING	CURRENT SOURCING
A	High Brightness (HB) LED	Single Common	EMI/RFI	Sourcing
B	High Brightness (HB) LED	Single Common	EMI/RFI	Sinking
C	High Brightness (HB) LED	Split Common	EMI/RFI	Sourcing
D	High Brightness (HB) LED	Split Common	EMI/RFI	Sinking
E	HB LED with Voltage Dimming 1/	Single Common	EMI/RFI	Sourcing
F	HB LED with Voltage Dimming 1/	Single Common	EMI/RFI	Sinking
G	HB LED with Voltage Dimming 1/	Split Common	EMI/RFI	Sourcing
H	HB LED with Voltage Dimming 1/	Split Common	EMI/RFI	Sinking

SUMMARY:

The white LED package provides an easy upgrade path for current users and an excellent option for new applications. Intelligent design makes the StacoSwitch white LED offerings reliable, affordable, and adaptable to customer needs.

Staco Incandescent Series AV17



Appearance: Sunlight readable "deadfront" legends provide a sleek modern look to enhance your avionics application.

Firm positive switch action provides a lifetime tactile feel that instills user confidence. Able to meet stringent military specifications, The AV17 Series will stand up to the most demanding avionics requirements. The AV17 series is specifically designed for those critical applications where reduced size and weight is a prime requisite. With 230 standard legends, 6 lighting colors, 4 separate light circuits and 2 form "C" switching circuits...You get 1 very versatile switch product to control even your most complex avionics.

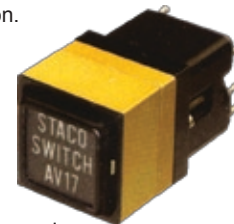

Display Pushbuttons:

- "Deadfront" Legends
- LED or Incandescent
- LED life of 100,000+ hours
- Sunlight Readable
- Low Power Consumption
- Sealed Units
- Low Heat Rise LED lighting
- Standard EFIS legends & lighting

- Switches:**
- DPDT Circuitry
 - Silver or Gold contacts
 - Sealed units
 - Easy solder termination
 - Crimp pin termination
 - Momentary or alternate action or indicator only

Slot Mounting: For horizontal or vertical slot mounting of two or more individual mount switch/indicators, L = length of horizontal mounting slot (or height of vertical) and N = number of units in a row. $L = .752" \times (N-1) + .690"$. The width of the slot should be .690". A minimum of .140" spacing between rows is recommended.

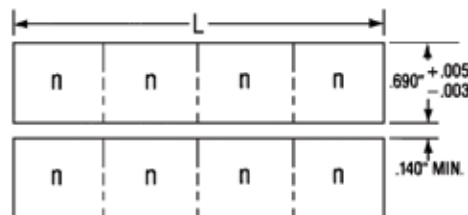
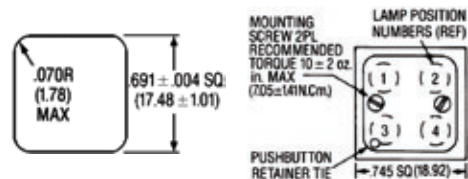
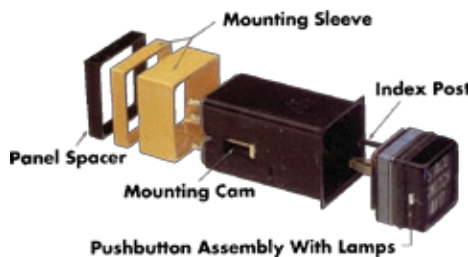



Staco Switch Push-Button Assembly Information

Legend Type "A"



Legend Type "B"

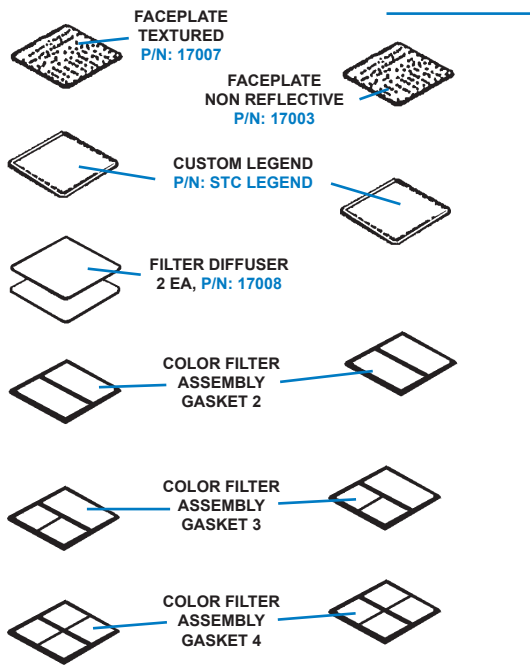

Stack these items tightly together, place inside of Faceplate Seal P/N: 17002, then slide them into the Bezel P/N: 17001

Bezel then snaps onto the Lampbox Assembly

Note:
P/N: 17003
Faceplate non-reflective surface must face upward.

Staco Switch Push-Button Wiring Diagram

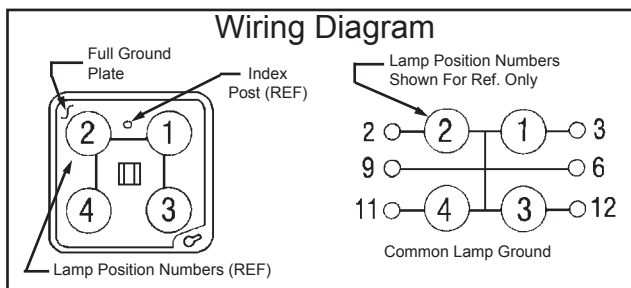

WITH THE EDMO COPILOT YOU CAN...

View Featured Closeouts

Closeouts Up To 99% Off!

See the Deal of the Day



DEAL OF THE DAY

Check product pricing and availability

A300 Ramp; BOEING EXCEPT 727 TOP		DM C50-17
	Qty On Hand: 8	
	List Price: \$2,346.00	
	MFP: N/A	
	Dealer Cost: \$1,484.84	
	View/Buy	

ALL FROM YOUR DESKTOP!

Learn more at WWW.EDMO.COM



Switch FAX In Order Worksheet

Please make a copy of this page. Complete the worksheet and FAX it to EDMO.

EDMO FAX 800-828-0623

Date: _____

Company: _____

Your Name: _____

Phone: _____ Fax: _____

1) Switch or Indicator Assembly Part Number: _____

2) If Ordering "Crimp" Style, Quantity of Sockets, (min. 25): _____

3) Lamp Part Number and Quantity: _____

4) Push-Button Assembly Display Style: _____

(Choose from one of the 8 styles below)

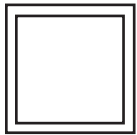

1

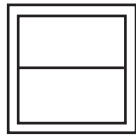

2

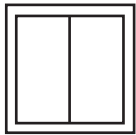

3

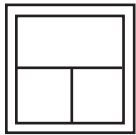

4

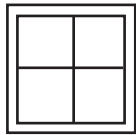

5

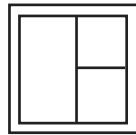

6

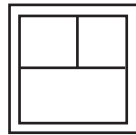

7

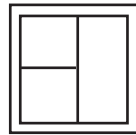

8

5) Legend Color or Colors:

Draw the display style you have selected and include the color number in each segment.

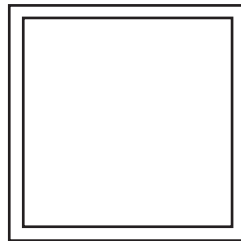

- 0 = Clear White
- 1 = Red
- 2 = Green
- 3 = Amber Yellow
- 4 = Luner White
- 5 = Lemon Yellow
- 6 = Blue

6) Custom Legend:

Draw the display style you have selected and include the text specifications in each segment.

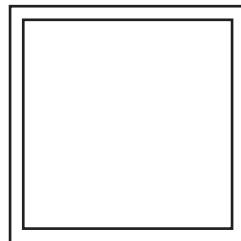

Text Note:

- Full Screen, Maximum of (4) lines with (7) characters per line.
- Full Screen, Horizontal, Maximum of (2) lines with (7) characters per line.
- Full Screen, Vertical, Maximum of (2) columns with (7) characters per column.
- Half Screen, Maximum of (2) lines with (4) characters per line.



EATON Series 582 Switch

EATON

Avionic Switch 582

Designed for use in the crew stations of commercial and military aircraft, shipboard systems, off road vehicles and commercial applications requiring a high reliability switch with superior lighting. The 582 is a Series 581 switch mechanism with upgraded lighting capabilities and more options. The Series 581 is qualified to MIL-S-22885/101.

The switch design has evolved from specific customer requirements. We asked the people who manufacture avionics, vetronic and shipboard equipment what was needed in a two pole, lighted pushbutton switch. The answers that came back included reliability, light weight, short behind panel depth, sunlight readability, night vision imaging system compatibility, LED illumination, spray-tight sealing and plug-in mounting. The Series 582 provides these capabilities.

Since 1942, our lighted indicators and pushbutton switches have proven to be the best in the industry at meeting customer requirements for quality, reliability, variety of options and technical performance. Your program needs will be supported by a committed team of people at Eaton. Eaton wants to be your long-term partner in product innovation, just-in-time delivery, electronic data interchange, quality improvement and responsiveness to changing design needs. A tour of our factory will prove our commitment to continuous improvement, quality control and responsiveness.

Features:

Switch Design. The Series 582 is a one or two pole, Form C switch available in momentary and indicating alternate configurations. It is also available in a simple indicator configuration. The Series 582 is supplied with gold-plated terminals and has a lamp capsule retention system that prevents the accidental interchange of capsules during relamping, maintaining the orientation of the capsule in relation to the switch body. Lamp Capsule Replaceability and Retention.

The lamp capsule retention system allows the removal and replacement of the lamp capsule, without requiring the replacement of the switch body, providing the lowest spares cost to the equipment operator. It also prevents the accidental interchange of capsules during relamping, maintaining the orientation of the capsule in relation to the switch body. This prevents accidental mis-orientation of the lamp capsule with the switch body during lamp replacement. Dual Mounting Pawls.

In order to ensure switch mounting integrity, two mounting pawls are supplied in the 582 which ensure balanced engagement force with the panel. Two pawls provide balanced clamping forces with the panel for superior performance under shock and vibration, and offer added safety in the event of a pawl failure or damage.

Call EDMO for more information.

Stormscope® Skywatch™ Switch

When installing the Stormscope® Skywatch™ system, use this EATON 582 series switch with factory legend. PMA approved

P/N: 4822-1046

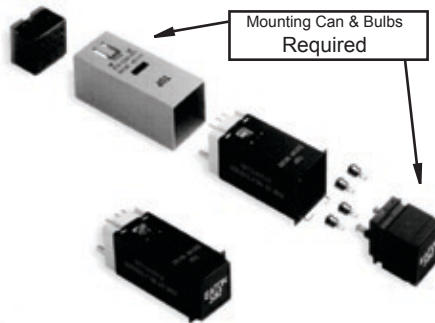

GPS Switch Kits



Electromech Lighted Push-Button Switch

The 6542350 (alternate) & 6542150 (momentary) lighted pushbutton switches use four bulbs, providing a redundant safety feature for IFR installations. Legend colors are green & blue. Other colors are available.

Technical Specifications:

Gold Contacts

Rating: 30 volts DC or 115 volts AC,
2amps resistive; 1 amp induc-

tive

Weight: .8 oz.

Actuations: 100,000

Mounting Hole: .875 X .875 Square.

P/N:

6542350

Description:

Lighted Alternate pushbutton switch (Green/Blue)

6542350CLR

Lighted Alternate pushbutton switch /custom/black/type B

6542150

Lighted Momentary pushbutton switch (Green/Blue)

6542150CLR

Lighted Momentary pushbutton switch /custom/black/type B

ML-0330

14 V bulb

ML-0327

28 V bulb

ML-0328

6 V bulb

Electromech Lighted Indicator

The 6543210 lighted indicator uses four bulbs, providing a redundant safety feature. Custom legends and different color choices make these indicators useful in many diverse applications. Legend colors are red & amber. Other colors are available.

P/N:

6543210

6543210CLR

Description:

Lighted indicator (Red/Amber)

Lighted indicator /custom/black/
type B

ML-0330

14 V bulb

ML-0327

28 V bulb

ML-0328

6 V bulb

Technical Specifications:

Rating: 30 Volts DC or 115 Volts
AC, 2 Amps Resistive: 1
Amp Inductive

Weight: 0.8 oz. (approx)

Operating Pressure: 2 lbs + 1lb

Plunger Travel: 3/16" (approx)

Actuations: 100,000



Dead Front Type "B"



Clear Front Type "A"

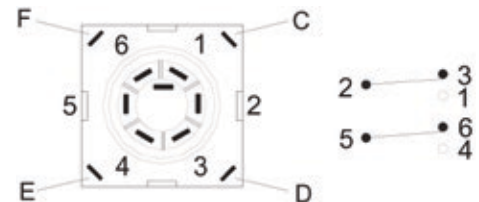



Series 600, 3/4" Square

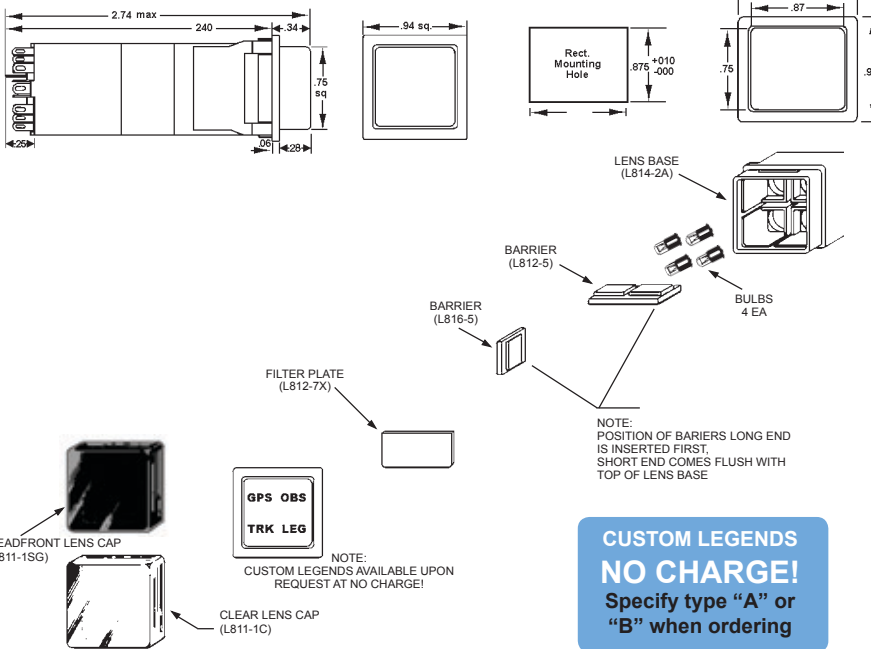

CUSTOM LEGENDS NO CHARGE!
Specify type "A" or "B" when ordering

Note: Full face switches available as custom request

These are the standard legends shipped with each Electro-Mech switch (Shown actual size). Type "A" is clear with Black Text, Type "B" is black with Clear Text.

NAV 1	NAV 2	NAV	VHF	VOR ILS	WP ALRT	VOR	GPS
LORAN	LORAN	LORAN	LORAN	LORAN	LRN WRN	LORAN	LORAN
NAV 1	NAV 2	NAV	VHF	VOR ILS	WP ALRT	VOR	LORAN
GPS	GPS	GPS	GPS	GPS	GPS WRN	GPS	GPS
MSG	WPT	WARN	PT	WPT	MSG	MSG	MSG
WARN	APPRCH	ADV	WARN	WARN	GPS	LORAN	HOLD

STACO / EATON Switch Bulbs

P/N:	Description
OL1099	12V SUB-MINI/60 MILLI-AMP BULB
OL3229	14V SUB-MINI/40 MILI AMP BULB
OL3335	28V SUB-MINI/16 MILLI-AMP BULB
OL6839	28V SUB-MINI/24 MILLI-AMP BULB

Switch Mounts

L&M switch mounts were designed to simplify the mounting of multiple Staco and Eaton switches and annunciators. Made from high grade aluminum, glass bead blasted and black anodized for a clean finish.

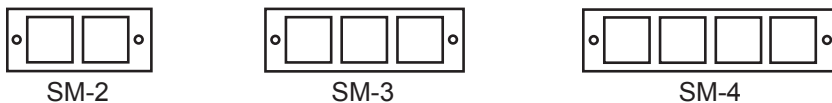

P/N:	Description:
SM-2	Dual Switch Mount
SM-3	Triple Switch Mount
SM-4	Quadruple Switch Mount

Altitude Encoders/Serializer



Model 8800

SHADIN Altitude Encoder/ Converter Model 8800 Automatic Altitude Data for Loran & GPS Receivers. Provides Mode-C grey code data to transponder, can provide high resolution (10 ft) RS232 serial data to selected GPS systems so altitude data is automatically input. Provides high resolution altitude data for IVS calculations. Can substitute as the 4th NAV satellite when only 3 satellites are in view. Altitude range:-1000 to 35,000 ft.

P/N: Description:
8800M II Morrow
8800T Trimble/Garmin
IK8800 Install Kit Altitude Encoder

Model 9200

Designed to be interfaced to the aircraft's existing Mode-C encoder in addition to tapping into the aircraft's static system. This allows high resolution altitude RS232 data (1 ft increments) to be fed to the GPS / AMS2000 for automatic altitude updating. Additionally, the serializer data can substitute as the 4th NAV satellite for many of the current GPS systems. This is not an encoder! The Shadin serializer has many of the benefits of the Falcon Encoder at a greatly reduced price.

P/N:	Description:
9200M	II Morrow
9200T	Trimble/Garmin



Model 3000

The Icarus Model 3000 Altitude Serializer enhances the usefulness of most aircraft GPS receiver. By providing the receiver with the aircraft's Mode C altitude, two dimensional navigation is available 24 hrs a day anywhere in the world with only three satellites in view. The Model 3000 also assists the receiver in determining 2D position when a satellite is lost

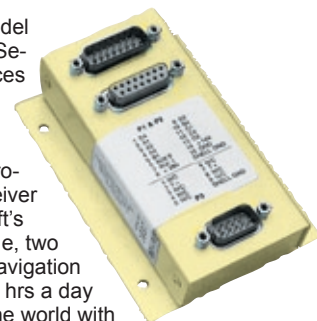



due to antenna blanking in a turn. The Warning flag will virtually never appear when the model 3000 is used to supplement satellite reception. If the aircraft is climbing or descending, substantial position errors are caused if the number of satellites in view goes below four, and the last computed altitude is not updated. The Model 3000 eliminates the need to manually enter the aircraft's altitude when only three satellites are in view.

Most GPS receivers have the ability to view your Mode C encoder's output. This enables you to check on the encoder's accuracy by temporarily setting your altimeter to 29.92 and comparing the altitude on your pressure altimeter with that displayed on the receiver. The Model 3000 Serializer easily installs in any aircraft equipped with a Mode C encoder. It is equipped with two connectors to facilitate the connections to the existing encoder's output and transponder. Since it connects to your primary encoder, the Mode C altitude that you can view on the receiver is the same altitude that is being transmitted to ATC. Since the serializer connects electrically to your existing encoder, the static system is not disturbed, and no recalibration is required.
P/N: **3000U**

Model IA-RS232C-S Interface Adapter (Serializer)



Designed to convert parallel 10-bit ICAO pressure altitude data to a fan-out of two RS-232 compliant outputs, the IA-RS232C-S is an all solid-state Interface Adapter (Serializer.) This device provides a simple and robust means of converting parallel

data into serial data and retransmitting to multiple aircraft systems in a compact package.
P/N: **IA-RS232CS**

Model IA-RS232C-D Dual Port Interface Adapter (Serializer)

Designed to convert parallel 10-bit ICAO pressure altitude data from TWO altitude reporting digitizers to a fan-out of two RS-232 compliant outputs, the IA-RS232C-D is an all solid-state Interface Adapter (Serializer). The IA-RS232C-D will accept data from only one digitizer at a time. This device provides a simple and robust means of converting parallel data into serial data and retransmitting to multiple aircraft systems in a compact package.
P/N: **IA-RS232CD**



GPS Remote Switches & Annunciators

COBHAM

RS08, RS12 & RS24 Remote Switches

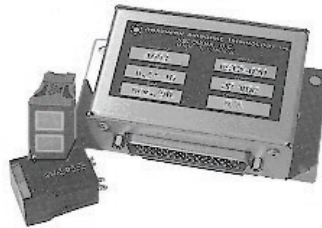

COBHAM GPS transfer switches allow large numbers of data or audio lines to be transferred with a single ground logic level. 14/28V operation is provided and additional functions are included to make aircraft installation simpler. The RS series of remote switches is recommended by many GPS manufacturers, and has been flight proven in over 8,500 installations in all classes of aircraft. The RS12 & RS24 have more poles of switching for GPS "Approach Approved" installations, and are configured for multiple independent switching operation.

P/N:	Description:
RS12-020	GPS/LORAN DATA SWITCH/20K
RS12-030	RS12-020 W/VOLTAGE KEYING
RS12-350	GPS/LORAN DATA SWITCH/35K
RS12-500	GPS/LORAN DATA SWITCH/50K
RS12-IKC	INSTALLATION KIT (CRIMP)
RS12-IKS	SOLDER KIT FOR RS12 SERIES
RS24-020	GPS/LORAN DATA SWITCH
RS24-350	GPS/LORAN DATA SWITCH/35K
RS24-500	GPS/LORAN DATA SWITCH/50K

RS16 Modular Remote Switch

The RS16 provides user definable remote switching func-



tions for more complex operations. It can work with both voltage or ground keying, and has an independent ILS reversion logic switch (for ground keying mode). Each four-pole switch has it's own status annunciation for fault monitoring and airframe troubleshooting. Dry nitrogen filled, gold contact, sealed relays provide dry-circuit to 0.5A switching range. Suitable to 35,000'.
P/N: **RS16-001**

ANNUNCIATORS & PUSH-BUTTON SWITCHES

LD08 Annunciator Lamp Dimmer

For use with the RS08/RS12 remote switches. Provides lamp dimming and test functions.
P/N: **LD08-001**



AK-950 Series Remote Relay Assembly



Ameri-King AK-950 SERIES REMOTE RELAY ASSEMBLY

P/N:	Pole:	Voltage:
9501R8-14	8	14
9501R8-28	8	28
9501R12-14	12	14
9501R12-28	12	28
9501R24-14	24	14
9501R24-28	24	28
9501R48-14	48	14
9501R48-28	48	28

GPS/NAV Switching & Annunciator Panels

Ameri-King Part Numbers

AK-950 SERIES GPS/NAV SWITCHING & ANNUNCIATOR PANELS

EDMO P/N:	Ameri-King P/N:	For Use With:	Mount:	Voltage:
950-K1-14H	950-90B-14-H	King KLN-90B	Horizontal	14
950-K1-14V	950-90B-14-V	King KLN-90B	Vertical	14
950-K1-28H	950-90B-28-H	King KLN-90B	Horizontal	28
950-K1-28V	950-90B-28-V	King KLN-90B	Vertical	28
950-K2-14H	950-900-14-H	King KLN-900	Horizontal	14
950-K2-14V	950-900-14-V	King KLN-900	Vertical	14
950-K2-28H	950-900-28-H	King KLN-900	Horizontal	28
950-K2-28V	950-900-28-V	King KLN-900	Vertical	28
950-K3-14H	950-89B-14-H	King KLN-89B	Horizontal	14
950-K3-14V	950-89B-14-V	King KLN-89B	Vertical	14
950-K3-28H	950-89B-28-H	King KLN-89B	Horizontal	28
950-K3-28V	950-89B-28-V	King KLN-89B	Vertical	28
950-G1-14H	950-300-14-H	Garmin GNC 300/300XL/155XL	Horizontal	14
950-G1-14V	950-300-14-V	Garmin GNC 300/300XL/155XL	Vertical	14
950-G1-28H	950-300-28-H	Garmin GNC 300/300XL/155XL	Horizontal	28
950-G1-28V	950-300-28-V	Garmin GNC 300/300XL/155XL	Vertical	28
950-G6-14H	950-G6-14H	Garmin GNC 400	Horizontal	14
950-G6-14V	950-G6-14V	Garmin GNC 400	Vertical	14
950-G6-28H	950-G6-28H	Garmin GNC 400	Horizontal	28
950-G6-28V	950-G6-28V	Garmin GNC 400	Vertical	28
950-G2-14H	950-165-14-H	Garmin GNC 165/155	Horizontal	14
950-G2-14V	950-165-14-V	Garmin GNC 165/155	Vertical	14
950-G2-28H	950-165-28-H	Garmin GNC 165/155	Horizontal	28
950-G2-28V	950-165-28-V	Garmin GNC 165/155	Vertical	28
950-G3-14H	950-250-14-H	Garmin GNC 250	Horizontal	14
950-G3-14V	950-250-14-V	Garmin GNC 250	Vertical	14
950-G3-28V	950-250-28-V	Garmin GNC 250	Vertical	28
950-T1-14H	950-2000-14-H	Trimble TNL 2000A/T	Horizontal	14
950-T1-14V	950-2000-14-V	Trimble TNL 2000A/T	Vertical	14
950-T1-28H	950-2000-28-H	Trimble TNL 2000A/T	Horizontal	28
950-T1-28V	950-2000-28-V	Trimble TNL 2000A/T	Vertical	28
950-T2-14H	950-2101/O-14-H	Trimble TNL 2101/O	Horizontal	14
950-T2-14V	950-2101/O-14-V	Trimble TNL 2101/O	Vertical	14
950-T2-28H	950-2101/O-28-H	Trimble TNL 2101/O	Horizontal	28
950-T2-28V	950-2101/O-28-V	Trimble TNL 2101/O	Vertical	28
950-T3-14H	950-8100-14-H	Trimble TNL 8100/HT-9000	Horizontal	14
950-T3-14V	950-8100-14-V	Trimble TNL 8100/HT-9000	Vertical	14
950-T3-28H	950-8100-28-H	Trimble TNL 8100/HT-9000	Horizontal	28
950-T3-28V	950-8100-28-V	Trimble TNL 8100/HT-9000	Vertical	28
950-M1-14H	950-GX50/60-14-H	II Morrow GX-55/60	Horizontal	14
950-M1-14V	950-GX50/60-14-V	II Morrow GX-55/60	Vertical	14
950-M1-28H	950-GX50/60-28-H	II Morrow GX-55/60	Horizontal	28
950-M1-28V	950-GX50/60-28-V	II Morrow GX-55/60	Vertical	28
950-M2-14H	950-SL50/60-14-H	II Morrow SL-55/60	Horizontal	14
950-M2-14V	950-SL50/60-14-V	II Morrow SL-55/60	Vertical	14
950-M2-28H	950-SL50/60-28-H	II Morrow SL-55/60	Horizontal	28
950-M2-28V	950-SL50/60-128-V	II Morrow SL-55/60	Vertical	28
950-GX-14H	950-GX55-14-H	II Morrow GX-55	Horizontal	14
950-GX-14V	950-GX55-14-V	II Morrow GX-55	Vertical	14
950-GX-28H	950-GX55-28-H	II Morrow GX-55	Horizontal	28
950-GX-28V	950-GX55-28-V	II Morrow GX-55	Vertical	28
950-M3-14H	950-M3-14-H	North Star M3 Approach/Enroute	Horizontal	14
950-M3-14V	950-M3-14-V	North Star M3 Approach/Enroute	Vertical	14
950-M3-28H	950-M3-28-H	North Star M3 Approach/Enroute	Horizontal	28
950-M3-28V	950-M3-28-V	North Star M3 Approach/Enroute	Vertical	28
950-U1-14H	950-UNS1-14-H	Universal Avionics UNS-1	Horizontal	14
950-U1-14V	950-UNS1-14-V	Universal Avionics UNS-1	Vertical	14
950-U1-28H	950-UNS1-28-H	Universal Avionics UNS-1	Horizontal	28
950-U1-28V	950-UNS1-28-V	Universal Avionics UNS-1	Vertical	28



GPS/NAV SWITCHING & ANNUNCIATOR PANEL

MICRO SIZE, 24 Poles relays built-in FAA TSO-C129a and STC approved. Specify 28 Vdc or 14 Vdc. Applicable to all GPS available in the Market.

FEATURES:

- World's Smallest Annunciator Panel with 24 Relays built-in.
- Minimum Panel Space required (2.12" W x 1.00" H x 2.63"D) only.
- ILS Annunciator with or without Auto Override. (Meets Canadian Regulation.)
- Silver Ring Front Bezel Panel to match with other Avionics Silver Crown Radios.
- Illuminated Pushed Buttons Switches with Soft Activated Force for easy Operation during Air Turbulence.
- Automatic Dimming with Photocell Detector and Lamp Test.
- Sun Light Readable with Extra Large Lettering for easy Reading.
- Single Connector for simplified Installation.
- Front or Rear Horizontal/Vertical mounting.
- Optional Pre fabricated Mil SPEC Wiring harness assemblies.
- Micro Size, Light weight (0.35 Lbs.)

ACCESSORIES:

- Machined Crimped type connector Kit.

WARRANTY:

- Two (2) Years. Optional Extended Four (4) years Warranty.

AK-950 Vertical Switching & Annunciator Panel



AK-950 Horizontal Switching & Annunciator Panel





AMPLIFIED GPS SPLITTERS

The GPS NETWORKING ALDCBS1X4 GPS antenna splitter is a one input four output amplified power divider designed specifically for the GPS L1 & L2 carrier frequencies. Three of the output legs (J2-J4) are DC-Blocked to prevent antenna damage, they also have 200 ohm DC loads to ground to simulate a GPS antenna pre-amp current draw. The other output leg (J1) is a DC short to power the antenna. All GPS antenna splitters are available with N-type, SMA or TNC connectors.



Options:

Network -(N) - This option gives you a splitter that has its own power source & all output ports are DC-blocked. When you designate the Network option by putting an "N" at the beginning of the part number you must also designate the antenna voltage to be provided by the splitter power source as well as the source voltage. The antenna voltage is placed immediately after the connector type and then followed by the source voltage. For Example: NLDCBS1X2-N/5/110 is a 1X2 splitter with the "N"etwork option, N-type connectors, a 5VDC antenna voltage & a 110V source. The antenna voltage range is +4 - 15VDC. The Source voltages available are 9-32 VDC/110AC/220EuroAC/230UKAC.

Hi-Isolation (HI) - This option gives you a splitter that has high isolation (40db) between output ports. When you designate the Hi-Isolation option by putting an "HI" at the beginning of the part number you will not get full amplification (20+db). The Hi-Isolation option gives you 3dB gain on a 1X4. Order Example: HILDCBS1X4-N is a 1X4 splitter with the HI-isolation option with N-type connectors.

Applications:

Amplified splitters are used in the same applications as our basic splitters, with the added amplification allowing for a longer cable run after the splitter.

Amplified splitters with the Hi-Isolation option are a good option when you are mixing different brands of receivers, older receivers or less expensive receivers. Some GPS receivers leak the local oscillator, their clock signal or reflect the GPS signal due to a less than optimum input VSWR. This causes degradation in performance. This can vary from a slight loss of performance, to the point, that one or more of the receivers no longer operate. The Hi-Isolation option prevents these problems.

P/N: **ALDCBS1X4**

ALDCBS1X2

The ALDCBS1X2 GPS Amplified Splitter is a one input, two output device with a 20dB min. gain block.

The frequency response covers the GPS L1, L2 and GLONASS bands with excellent gain flatness. In the normal configuration, the splitter RF output (J1) passes DC from the connected GPS receiver through the splitter to the antenna, allowing the GPS receiver to power both the antenna and the splitter amplifier.

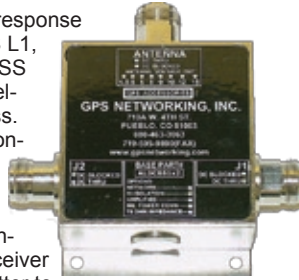

The other RF output (J2) is DC loaded with a 200 Ohm resistor to simulate the antenna current draw.

P/N: **ALDCBS1X2**

NETWORK RE-RADIATING ANTENNA



The PNRRKIT is a Re-radiating system which allows you to re-radiate the GPS L1 carrier indoors. The PNRRKIT consists of a plug-in Re-Radiating amplifier & a Re-Radiating Antenna. It differs from the HNRRKIT in that it does not provide a roof antenna. The PNRRKIT does not provide a DC voltage for a GPS antenna or source. The Re-radiating amplifier has a 110V/220V Plug-in transformer which powers the amplifier. A GPS signal must be provided (from a GPS antenna splitter for example) at the front end of the PNRRKIT, it is then amplified and radiated out the Re-radiating antenna. If the receiving antenna has line of sight with the Re-radiating antenna, it will receive the signal up to 100 feet away. The customer must designate the source voltage(110/220/6-30VDC). For Example: PNRRKIT-N/110 is a Portable Network RRRKIT with a 110V source. If the customer wants this amplifier to power an antenna, he must designate the antenna voltage after the connector type. Example: PNRRKIT-N/5/110 is a portable network RRRKIT with 5V antenna voltage and a 110V source voltage. All Re-radiating Kits are available with N-type, SMA or TNC connectors. Note: For Sale to Government and Foreign Customer!



"This device has not been authorized as required by the rules of the Federal Communications Commission. This device is not, and may not be, offered for sale or lease, or sold or leased, until authorization is obtained."

Mounting Options:
WRUMT Universal mount for indoor installation of RRRKIT amplifier and antenna

Applications:

The HNRRKIT is a necessity if you want to test your GPS receiver indoors with the antenna connected. The HNRRKIT allows you to track GPS while inside a hanger or garage. This allows you to work out problems and see failures in GPS systems before they are deployed.



P/N:
L1RRKPA-S
HNRRKIT110
WRUMT
L1GPSA-N

Description:
RE-RADIATING ANTENNA
GPS RE-RADIATING KIT/110V
HNRRKIT AMPLIFIER MOUNT
L1 ROOF ANTENNA/ACTIVE
N CONN
L1 ROOF ANTENNA/ACTIVE
L1 ROOF ANT MOUNTING
BRACKET

L1GPSA-S
RAMB-L1

GPS RE-RADIATING KIT



The HNRRKIT is a complete re-radiating system to allow you to re-radiate the GPS L1 carrier indoors. The HNRRKIT consists of a Roof Antenna, a plug-in re-radiating amplifier & a re-radiating antenna. The roof antenna is a 38db Gain, 50 ohm antenna. The re-radiating amplifier has a 110V/220V Plug-in transformer which powers the amplifier and the roof antenna. The signal from the roof antenna is amplified and radiated out the re-radiating antenna. If the receiving antenna has line of sight with the re-radiating antenna, it will receive the signal up to 100 feet away. All re-radiating Kits are available with N-type, SMA or TNC connectors. The antenna voltage is set at 5VDC. The customer must designate the source voltage(110/220/6-30VDC). For Example: HNRRKIT-N/110 is a Hanger Network RRRKIT with a 110V source. Note: For sale to Government and Foreign Customers!



"This device has not been authorized as required by the rules of the Federal Communications Commission. This device is not, and may not be, offered for sale or lease, or sold or leased, until authorization is obtained."

Applications:

The HNRRKIT is a necessity if you want to test your GPS receiver indoors with the antenna connected. The HNRRKIT allows you to track GPS while inside a hanger or garage. This allows you to work out problems and see failures in GPS systems before they are deployed.



P/N:	DESCRIPTION:
HNRRKIT110	GPS RE-RADIATING KIT, 110 Volt
HNRRKIT220	GPS RE-RADIATING KIT, 220 Volt
WRUMT	Universal Mount For HNRRKIT
NLDCBS1X4-NRRKAMP	Network Antenna Splitter Amplifier, 5V, 110
XMRRKIT	XM, Sirius Re-Radiating Kit

GPS Notch Filter



Problem: Harmonic Noise Interfering with GPS Systems Solution: TED Manufacturing 4-70 GPS Notch Filter

Your global positioning system receives its positional information at 1575.42 megahertz. The communications radios on-board your aircraft typically broadcast in the 121.5 megahertz range. That is a wide separation in frequency bandwidth but it's not the complete picture. Your comm's are also producing harmonics which can produce significant noise at the GPS frequency.

Now you can filter that signal and avoid potentially hazardous situations.

The TED 4-70 notch filter is a simple low cost way to clean up the receivers frequency environment.

The TED 4-70 notch filter installs quickly and easily via standard BNC bayonet couplings, in-line between radios and antenna. The 4-70 rejects in excess of 50dB of 1575.42 signal at the source. Each filter is individually tuned and checked to assure maximum performance. Of course, the 4-70 also passes strenuous environmental criteria so important in aircraft applications.



Major GPS manufacturers recognize this problem and recommend using the 4-70 on new and retrofit installation.

TED Manufacturing has been producing the highest quality components to the most exacting tolerances for the aviation industry for more than 35 years. TED Manufacturing goes beyond the point of simply meeting engineering minimums. At TED, we believe superb quality is fundamental and that exceeding customer expectations is our measure of success.

The GPS notch filter model 4-70 is just one example of how TED Manufacturing can put our experience to work for you to produce your special connector/filtering needs.

P/N: **4-70-54**

SPECIFICATIONS:

- Plating-Nickel
- Contacts-Nickel, with 30u Gold Plate
- Maximum Voltage - 500 Volts
- Dielectric Strength - 1500 Volts
- Insulation Resistance - 5000 Megohms
- Temperature Range-55°C to +85°C

Parameter:	Typ.:	Units:
Center Notch Frequency	1575.42	Mhz
Attenuation over F+1.5 Mhz	52	dB
Insertion loss from 118 to 137 Mhz	0.1	dB
Impedance from 118 to 137 Mhz	50	Ohms
VSWR from 118 to 137 Mhz	1.5:1	

Deklin Tech Adapter For GARMIN WAAS Upgrades



Deklin Technologies

As part of existing GNS430 and GNS530 upgrades to WAAS the antenna needs to be changed. The new antenna requires to TNC connector whereas the old antenna used a BNC. The choice is either to change the connector or use adapters. Changing the connector is not always practical due to usable cable lengths and/or location. The alternative is using a BNC to TNC adapter, ideally with a right angle. The DBFTMA-90 is just the adapter for the job. It has a high quality precision nickel body construction with a gold plated center conductor. It has a 50 ohm impedance, dielectric withstanding voltage in excess of 1,500V RMS, and a minimum insulation resistance of 5k ohm.

P/N: **DBFTMA-90**



SKYBOUND ADAPTER G2

If your GPS equipment uses a data card system for updating the Jeppesen database (usually applies to panel-mounted units), there is now an alternative to the old return-your-card-in-exchange-for-a-new-one routine. Use this USB adapter to update your GPS data card from your computer!



Skybound USB Minimum System Requirements:

- Pentium 266MHz or faster CPU
- 32 MB RAM minimum
- 10 MB free disk space
- Microsoft Windows 2000 SP3, or Windows XP SP1
- Microsoft Internet Explorer 6.0 or better
- Internet Connectivity
- Available USB port

P/N: **DSKYG241**

AIRGIZMOS Panel Docks



Garmin 295 GPS Panel Dock

As soon as we announced the availability of our Garmin 196/296 Panel Dock there was a down-pour of requests for a similar product for the popular Garmin 295 handheld GPS. The 295 is somewhat wider than the 196/296 and therefore will not fit in a standard 6.25" radio stack, but we have come up with a flexible mount that can be placed just about anywhere in the panel.

As with the 196/296 Panel Dock, the 295 is held safely and securely, but can be easily removed in a matter of seconds. The external power and antenna connections are made at the back of the unit, and the cables are secured from falling into the dock.

P/N: **AG-ITEM 2**
*GPS Unit Not Included



iPOD PANEL DOCK

One creature comfort that I wanted to install in my plane is my iPod. This is really more for my passengers than for myself, but the iPod is a great way to provide hours of entertainment without adding much weight. So, we designed a Panel Dock for it.

The iPod Panel Dock fits all first, second, and third generation iPod devices. It does not fit the iPod Mini, or any of the iPod knockoffs that are out there.



The iPod Dock can be installed to allow access to either the top plugs or the bottom plug. Just flip it the way you want it to go and mount it in your panel. The top plugs are useful for simple headphone-only connections, while the bottom plug allows you to fully integrate your iPod into your intercom and power system (a separate cable is required.)

P/N: **AG-ITEM 3**
*iPod Not Included

Garmin GPSMap 196/296/396 Panel Dock

The Panel Dock is designed to fit the Garmin GPSMap 196, 296 and 396 handheld GPS units.

The GPS is held firmly in place, but can be easily removed by pulling the release tab, located on the left side of the unit. The Panel Dock is designed to fit in a standard 6.25" avionics stack,





but it can also be flush-mounted anywhere else in the panel. We've worked hard to make it look like it belongs in a panel. The antenna and power cables slide through prefabricated "key-holes" in the back of the unit, which keeps the connectors from slipping back into the panel when the unit is removed.

P/N: **AG-ITEM 4**

*GPS Unit Not Included

AvMap EKP-IV GPS Panel Dock

The guys at AvMap have a really nice GPS. The display is big and bright. It displays terrain in vibrant color. The user interface is second to none. The only problem has been finding a way to mount it in your panel.

Now you can mount the beautiful, detailed display of the AvMap EKP-IV directly in your instrument panel using our AvMap EKP-IV Panel Dock. Our Panel Dock is designed to hold the AvMap securely yet it allows you to easily remove your portable from your plane whenever the need arises. The AvMap EKP-IV Panel Dock has all the safety and security features that our other Panel Dock products offer: easy installation, quick release, hassle free management of cables, and elegance of design.

P/N: **AG-ITEM 5**

*GPS Unit Not Included



Lowrance AirMap 1000/2000c GPS Panel Dock

We are happy to introduce a Panel Dock for the Lowrance AirMap 1000/2000c series of portable GPS receivers. This has proved to be a very popular unit because of its low price and comprehensive feature set. With the recent addition of the terrain module the 2000c is certainly worth considering if you need a color moving map GPS.

We have designed our Panel Dock to fit the AirMap in much the same fashion as our other Panel Dock products. The cables supplied by Lowrance fit through keyhole slots on the back of the unit. The release latch at the top of the Panel Dock permits quick removal of the device for use in another vehicle or simply for security purposes.

P/N: **AG-ITEM 6**

*GPS Unit Not Included



AVMAP GEOPILOT PANEL DOCK

This GPS has a nice large screen to go with its small size. The Panel Dock is designed to hold the GeoPilot securely in your panel while allowing it to be easily removed for portable use.

P/N: **AG-ITEM 17**



AVMAP GEOPILOT II+ PANEL DOCK

This GPS has a nice large screen to go with its small size.

Our Panel Dock™ is designed to hold the GeoPilot securely in your panel while allowing it to be easily removed for portable use.

P/N: **AG-ITEM 25**

*GPS Unit Not Included



LOWRANCE 600C PANEL DOCK

Lowrance makes a low cost handheld GPS that is just the perfect size for many panels. The Panel Dock will allow the AirMap 600c to be nicely mounted in your panel while still allowing it to be easily removed and used as a handheld.

P/N: **AG-ITEM 16**



GARMIN 695/696 PANEL DOCK

Did you fall in love with the display of the new Garmin 696? It really is a thing of beauty. As soon as we saw it we immediately made plans to install one of these in our own airplanes. So we set out to design a Panel Dock that solves the unique challenges of such a large device.

First and foremost we were committed to keeping the "footprint" of the Panel Dock to an absolute minimum. The 696 is already 5.7" wide by 7.7" high. So our tradition of adding a latch to the top or side of the Panel Dock had to be changed. We absolutely had to stay within the 6.25" width of a standard radio stack, and we really wanted the overall height to be as short as possible. Our solution is a latching



mechanism that is virtually invisible from the front of the dock and does not protrude beyond the overall footprint of 6.25" by 8".

Next, we needed to provide a way to manage the cables that connect to the 696. As with our other Panel Docks, we have provided keyholes that capture the cables and keep them from falling into the panel. The 696 is installed into the dock by resting the bottom of the GPS on the Panel Dock and attaching the cables. Then the GPS is snapped into the Panel Dock and finally it is latched in place using the latching wheel located on the right side of the dock.

As with our other Panel Dock products, the 695/696 Panel Dock allows you to securely mount your GPS in your panel while allowing you to remove the GPS from the plane quickly and easily. The result is a streamlined and professional installation that adds to the functionality of the GPS.

P/N: **AG-ITEM 29**

*GPS Unit Not Included

AV80R PANEL DOCK BENDIX KING

Panel Dock for Bendix/King AV80R.

- Fits in a standard Avionics Stack.
- Comes with 90° USB XM Weather Interface Cable.

P/N: **AG-ITEM 31**



Horizontal Angle Adapter

One comment that we've heard about the Garmin GPS is that it can be difficult to see if viewing from an angle.

This is especially noticeable when the GPS is mounted on the opposite side of the panel from the pilot. So, we've come up with a solution: the Angle Adapter.

It angles the GPS at a fixed angle of 15 degrees, providing a much more convenient viewing angle. This adapter fits in the same panel cutout as the Panel Dock, so if you already have a Panel Dock you can attach this adapter without having to modify your installation. You can mount the Angle Adapter in either direction, in case you fly in the right seat. In addition, by using this adapter you can expand your installation options, since it lets you surface-mount the Panel Dock on any instrument panel.

P/N: **AG-ITEM 7**



HORIZ TILT ADAPTER 695/696

Many pilots will need to install their GPS on the passenger side of the panel. To make the GPS more readable we offer the Angle Adapter. It works in conjunction with the Panel Dock™



and provides an additional 15 degrees of angle to the GPS, making it much easier to see and use.

The Angle Adapter fits in the same physical opening as the Panel Dock. The Panel Dock then slides into the Angle Adapter to complete the installation.
P/N: **AG-ITEM 30**



396 VERTICAL TILT ADAPTER

Following up the release of our Horizontal Angle Adapter we decided to address the needs of those pilots who mount their GPS lower on the instrument panel. The Vertical Tilt Adapter angles the viewing angle of the GPS so it is more readable when the GPS is mounted at the bottom of a tall instrument panel.



This adapter fits the same opening as the Panel Dock itself, so adding the vertical tilt should be very easy for existing installations.
P/N: **AG-ITEM 10**

GARMIN 196/296/396/496 Panel Dock Cover

Would you like more protection for your Garmin 196/296/396/496 Panel Dock? This cover is designed to protect the Panel Dock when the GPS is not installed or when it's in use. It will protect the portable GPS from the sun's damaging rays and from the eyes of envious onlookers.
P/N: **AG-ITEM 14**



396/496 XM PREMIUM ANT DOCK

The perfect companion to your new Garmin 396/496 and the AirGizmos Panel Dock. Now you can move the XM antenna from plane to plane, or from vehicle to vehicle, along with the GPS itself.

Designed to mobilize your costly 396/496 XM antenna. It helps to maintain the clean look of a permanent installation by organizing the antenna cable. Using the AirGizmos Antenna Dock you can freely move ONE XM antenna from location to location, avoiding high costs of additional equipment and



service subscriptions.

Attach the base to your antenna and install the cradle in the necessary location (you can install several cradles in different locations). Using a simple twist & lock mechanism (no tools required) the base will lock your antenna into the preinstalled cradle, and your 396/496 XM antenna is ready to go!
P/N: **AG-ITEM 18**



XM ANTENNA DOCK

This Antenna Dock is designed to help freely move an XM antenna from location to another to avoid high costs.
P/N: **AG-ITEM 8**



XM ANTENNA CABLE

Straight, 2 meter extension for Garmin XM Weather Antenna.
P/N: **AG-ITEM 9**

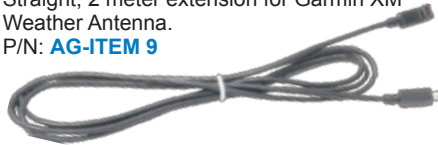

XM AERO DOCK

The Aero Dock gives you the option of mounting the XM antenna on the outside of the aircraft.
P/N: **AG-ITEM 12**



XM AERO COVER

Permanently mount an external XM antenna with this new Aero Cover. It fits all major antenna brands.
P/N: **AG-ITEM 13**



RIGHT ANGLE AUDIO CABLE/CA1

The cables supplied by Garmin for the 695/696 all have low-profile, right angle connectors. Garmin does not include an audio cable, and finding one that will fit has been a problem. Until now.



This is a cable that works with the Garmin 695/696. The six foot cable is high quality, shielded, 24 gauge wire with a low-profile, right angle connector on one end, and bare leads on the other end.
P/N: **AG-ITEM 32**



OUR QUALITY MOTTO:

QUALITY AND EXCELLENCE WHATEVER IT TAKES

For a full description of our Quality Manual, please visit us at WWW.EDMO.COM