

# PRECISION INDUCTOSYN<sup>®</sup> POSITION TRANSDUCERS

*for industrial  
automation,  
aerospace,  
and military  
applications*

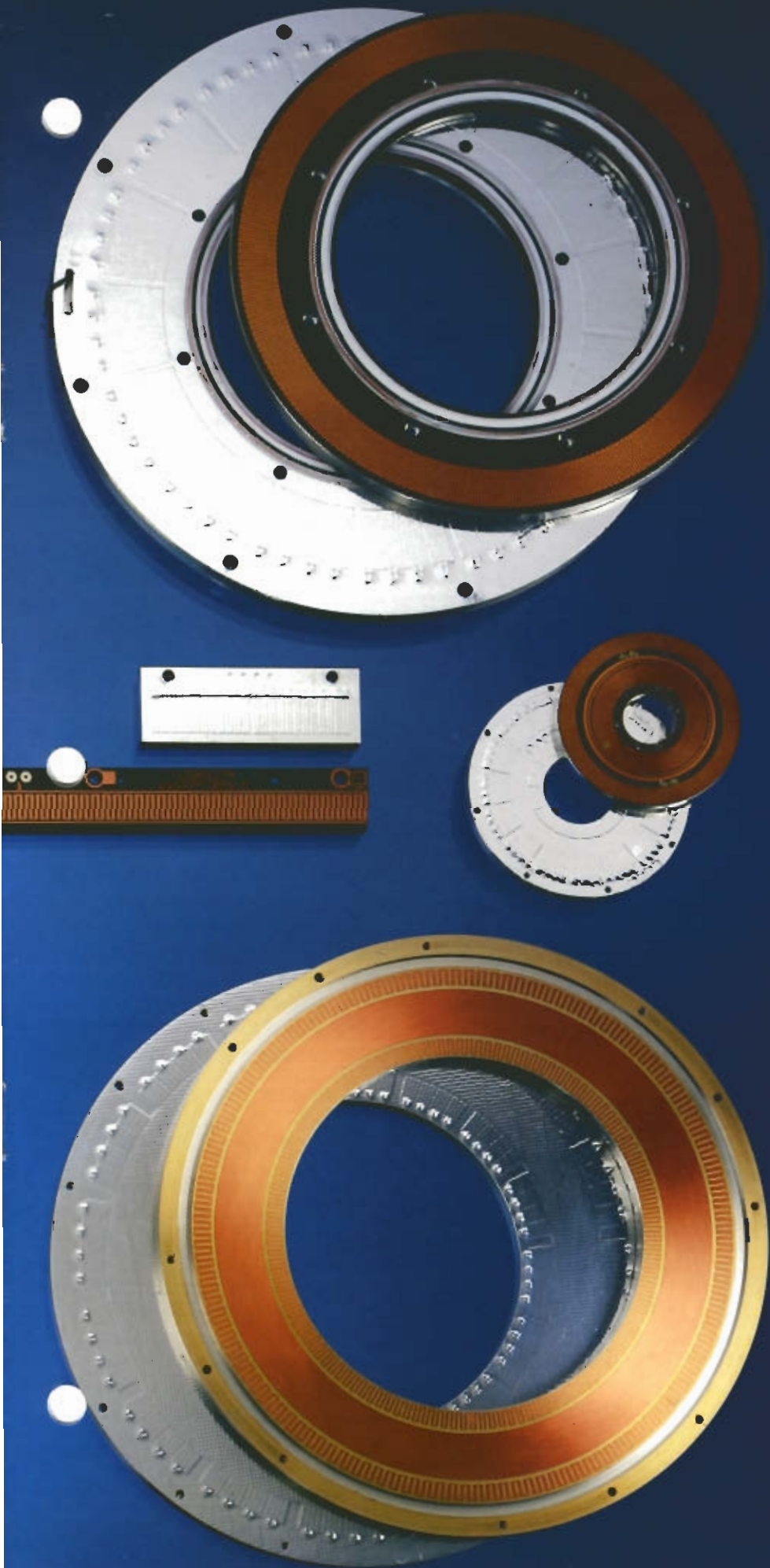

 **FARRAND  
CONTROLS**

## ABOUT FARRAND

Farrand Controls manufactures precision Inductosyn<sup>®</sup> transducers used for accurate measurement of angular or linear position displacements. Inductosyn transducers combine high accuracy, extreme reliability, and ruggedness to meet the demanding requirements of harsh military, space, and industrial environments. Currently, Inductosyn transducer applications include space satellites, submarine navigation systems, antenna pedestals, tracking mounts, telescopes, factory automation, robotics, machine tool control, cryogenic chambers, and hard vacuum chambers. In business since 1955, the quality and accuracy of our products have earned Farrand Controls the recognition as the leader in the field of high precision position control.

Our quality control and quality assurance programs guarantee performance to our customers' specifications. All Inductosyn transducers meet current commercial standards and can be designed to meet strict MIL specifications. We encourage visits to our plant to demonstrate our quality procedures and to discuss your individual needs.

At Farrand, we continuously evaluate and upgrade our Inductosyn position transducers based on improved technology and field experience. Our team of applications engineers welcomes the opportunity to work with our customers to satisfy their position measuring requirements. To meet individual needs, we will often customize one of our many Inductosyn transducer designs or create a new solution for your specific application.

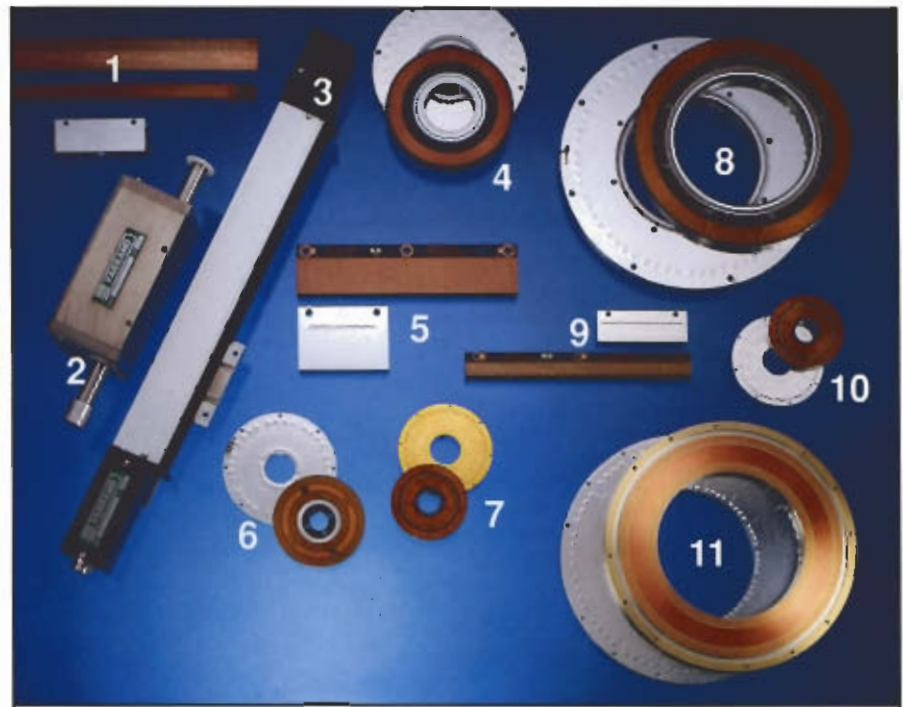

- |  |  |
|--|--|
| 1. Top: Tape scale, absolute, 4 mm and grey code<br>Middle: Tape scale, 0.1" cycle<br>Bottom: Slider, 0.1" cycle | 6. Rotary, 5" absolute, 128/126 pole                     |
| 2. Cassette, 3" travel, 0.1" cycle   | 7. Rotary, 4" absolute, 256/2 pole, space rated          |
| 3. Tape spar, compact, 12" travel, 0.1" cycle  | 8. Rotary, 12", 512 pole, with IRT                       |
| 4. Rotary, 7", 720 pole, with Integral Rotary Transformer (IRT)  | 9. Bar scale (narrow) and slider, 0.2" cycle             |
| 5. Bar scale and slider, 2 mm cycle  | 10. Rotary, 4" absolute, 256/2 pole                      |
|  | 11. Rotary, 11" absolute, 256/254 pole, with hard shield |

Inductosyn transducer units shown on cover.



# INDUCTOSYN® POSITION TRANSDUCERS, FEATURES AND BENEFITS

An Inductosyn transducer consists of two noncontacting elements, a scale and a slider for the linear transducer, and a rotor and stator for the rotary transducer. Inductosyn position transducers are a "printed circuit" form of electrical resolver. The printed circuit transducer patterns can be produced on almost any substrate material. The patterns are bonded onto the substrate material and the resulting elements are attached to the customer's fixed and moveable system parts. The most common Inductosyn transducer application uses inductive coupling between the moving patterns.

Since 1955, Farrand has manufactured thousands of highly accurate linear and rotary Inductosyn transducers. Applications include robotics, space satellites, submarine navigation systems, antenna pedestals, tracking mounts, telescopes, computer peripheral devices, machine tool control, and many unusual special applications.

## HIGH ACCURACY

Inductosyn position transducers satisfy your most demanding position measurement requirements. Standard units have accuracies to:

Linear:  $\pm 100$  microinches  
( $\pm 0.0025$  mm)

Angular:  $\pm 1$  arc second

Select units have accuracies to:

Linear: Better than  $\pm 40$  microinches  
( $\pm 0.001$  mm)

Angular: Better than  $\pm 0.5$  arc second

Repeatability is at least 10 times better than rated accuracy in most cases.

## NONCONTACTING ELEMENTS

The two elements of a rotary or linear Inductosyn transducer are never in contact and, as a result, have zero wear. The original accuracy is maintained indefinitely and reliability is unsurpassed. No adjustment or lubrication is ever required. In addition, noncontacting elements eliminate backlash and mechanical coupling errors.

## OPERATION IN HARSH ENVIRONMENTS

Inductosyn transducers will operate reliably, at full accuracy, in very harsh environments. They can be designed to resist the effects of dust, oil films, vapors, sea water, light radiation, extreme pressure, vacuum, high vibration and shock, and temperatures ranging from  $10^{\circ}\text{K}$  to  $160^{\circ}\text{C}$ .

## THERMAL STABILITY

Farrand engineers pioneered bonding techniques to allow the printed circuit transducer patterns to be produced on substrates of almost any material. As a result, Inductosyn components can be manufactured using the same alloys as the corresponding machine parts. This essentially "monolithic" construction in combination with the transducer pattern's configuration assures thermal stability from low cryogenic temperatures of  $10^{\circ}\text{K}$  or below to high temperatures of  $160^{\circ}\text{C}$  or above.

## ABSOLUTE & INCREMENTAL POSITIONING DATA

Inductosyn position transducers can provide either incremental or absolute position data. This data is used as input to digital position readouts or precision motion control systems.

## AVERAGING OUTPUT SIGNALS

Residual errors in conductor pattern spacing have little effect on Inductosyn output signals. The output signals arise from an average of all spatial cycles for rotary transducers and many spatial cycles for linear transducers.

## LINEAR TRAVEL TO 120 FT OR LONGER

Linear Inductosyn transducers are supplied as rigid bars or flexible tapes. Standard 10 inch (254 mm) bars can be mounted end to end to form continuous measuring systems of unlimited length. Continuous tapes to 120 feet (36.6m) or longer, can be supplied. High accuracy is maintained over the entire length.

## ABOUT FARRAND

*Page 2*

## INDUCTOSYN POSITION TRANSDUCERS FEATURES AND BENEFITS

*Page 3*

## OPERATING PRINCIPLES

*Page 4 - 5*

## HOW TO SELECT AND USE

### INDUCTOSYN POSITION TRANSDUCERS

*Pages 6 - 8*

## ROTARY INDUCTOSYN TRANSDUCERS

*Page 9 - 11*

## LINEAR INDUCTOSYN TRANSDUCERS

*Pages 12 - 13*

## ACCESSORIES

*Page 14*

## APPLICATIONS

*Page 15*

# OPERATING PRINCIPLES

## INDUCTIVE COUPLING BETWEEN PRECISION WINDINGS

Precision circuit patterns are etched in copper bonded to the surface of Inductosyn elements. For rotary Inductosyns, the printed circuit pattern comprises hairpin radial turns which repeat on the flat surface of a disk. For linear Inductosyns, the printed circuit pattern comprises parallel hairpin turns which repeat along the surface of a flat bar. The length of one complete cycle of the hairpin pattern is called the pitch ( $P$ ). See Figure 1A. Figures 3A and 3B illustrate the actual printed circuit pattern, referred to as windings, on linear and rotary Inductosyn transducers.

Inductive coupling between windings on a rotary or linear pair of elements is used to measure displacement. The Inductosyn elements are attached to the fixed and moveable machine parts with the elements aligned so that their winding patterns are mutually parallel and separated by a small air gap.

In Figures 1A, 1B, and 1C, winding  $W_2$  moves relative to stationary winding  $W_1$ . Application of an AC excitation signal,  $V_1$ , to the winding on one element will cause a current flow in that winding which simultaneously induces a corresponding current flow and output voltage,  $V_2$ , in the winding of the second element. See Figure 1A. The amplitude and phase of this induced voltage depends on the relative positions of the winding conductors. In Figure 1A, the induced voltage  $V_2$  is at maximum amplitude when the winding conductors  $W_2$  of one element are exactly aligned with the winding conductors  $W_1$  of the other element.

In Figure 1B, the induced voltage,  $V_2$ , passes through zero when the winding conductors,  $W_2$ , of one element are midway between the winding conductors,  $W_1$ , of the other element. The distance moved by  $W_2$ , from the position shown in Figure 1A to that shown in Figure 1B, is  $P/4$ .

In Figures 1A – 1C, winding  $W_2$  moves relative to stationary winding  $W_1$ .

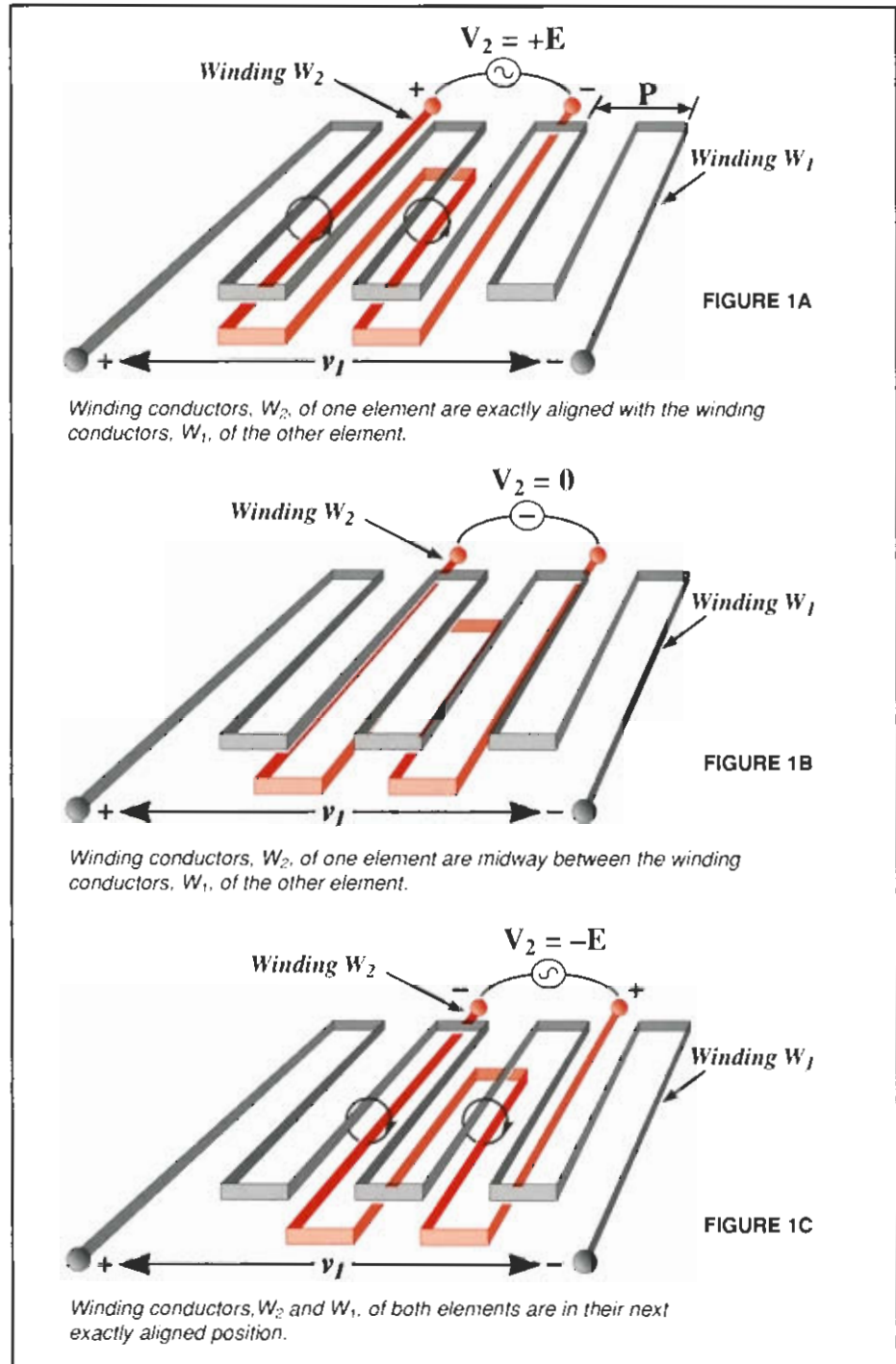

In Figure 1C, the induced voltage reaches a maximum amplitude of opposite phase when the winding conductors of both elements are in their next exactly aligned position. For simplicity, the phase reversal is shown as a change in polarity in Figure 1C.

The signal forms shown in the circles in Figure 1 are indicative of those that would be observed on an oscilloscope connected to the output winding. Winding  $W_2$  moved a distance  $P/2$ , between the positions shown in Figures 1A and 1C.



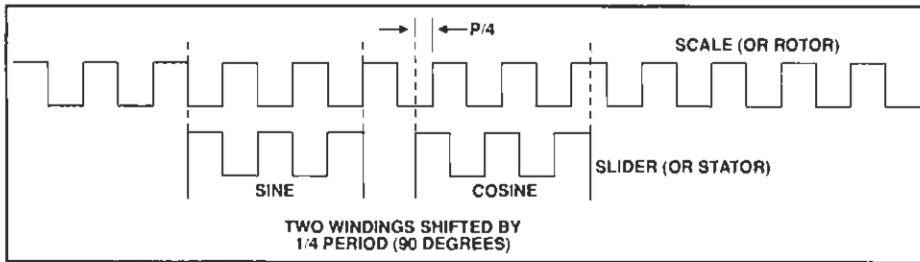

**FIGURE 2** Two separate identical windings on the slider. These two windings have exactly the same pitch, but one winding is shifted a distance  $P/4$  or  $90^\circ$  from the other winding.

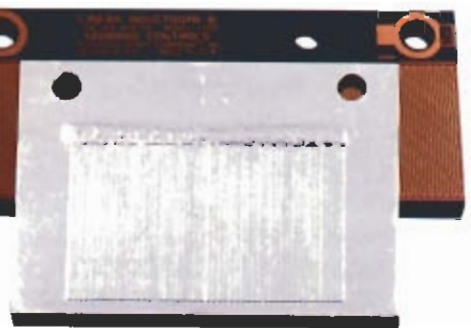
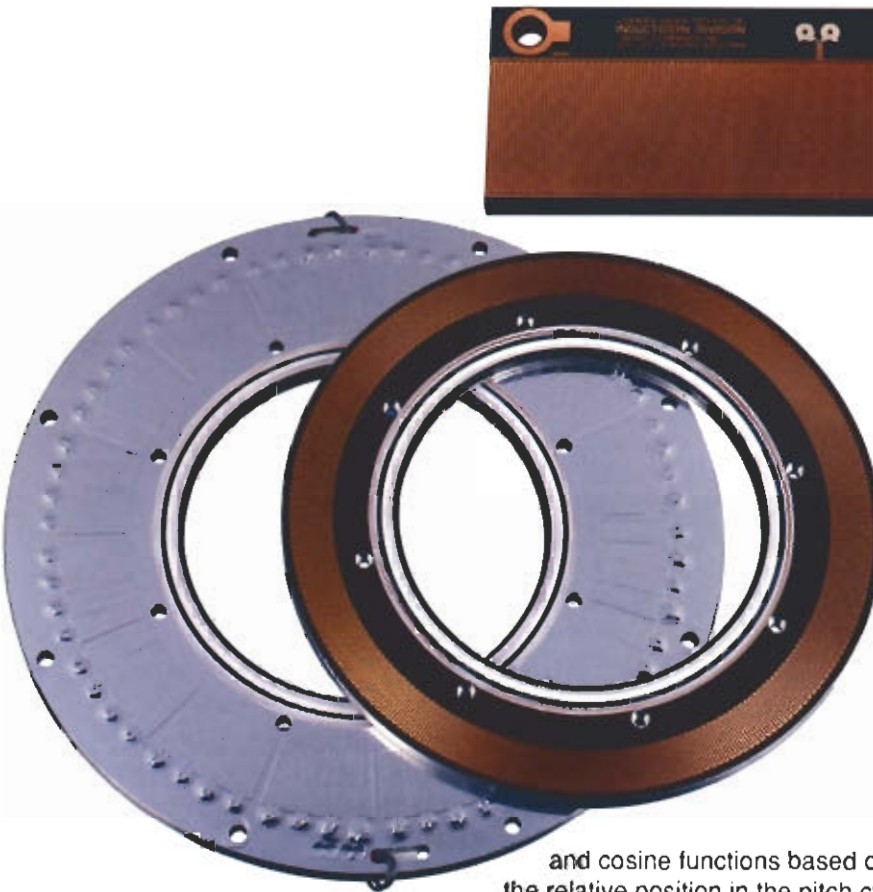

**FIGURE 3A** Parallel hairpin turns on a Linear Inductosyn Transducer.

**FIGURE 3B** Radial hairpin turns on a Rotary Inductosyn Transducer.

## VOLTAGE OUTPUT AS A FUNCTION OF POSITION

The induced voltage for positions intermediate to those shown in Figures 1A through 1C have values defined by a sinusoidal function. In actual practice, a second winding pattern is incorporated on one element such that it is displaced a distance  $P/4$  from the first winding pattern. An AC excitation signal applied to the one-winding element results in two output signals from the two-winding element. See Figure 2. The two output signals have amplitudes which vary as sine

and cosine functions based on the relative position in the pitch cycle.

The phase of the output signals remains constant except for the reversal of phase in the second half of the electrical cycle. There is a unique pair of sine and cosine output amplitudes for every position within one cycle of the pitch. The accurately known pitch interval may be subdivided with high precision by measuring and processing the sine and cosine amplitudes. Specific methods which can be used to subdivide the pitch cycle are described in the following section.

The Inductosyn windings in space quadrature act as a precision synchro resolver. The typical Inductosyn transducer is a multipole device. Therefore, its output resembles a multipole resolver or a mechanically geared resolver system. On a rotary Inductosyn, the fixed and moveable windings are called the stator and rotor, respectively. One cycle length on the winding equals two poles of a comparable resolver. Standard rotary Inductosyn designs range from 2 to 2048 poles. Linear Inductosyn "poles" are spaced at fixed linear intervals of  $P/2$ . Standard linear pitch values are 0.1 and 0.2 inch and 2 mm. Many other linear pitches are available. The fixed and moveable elements of a linear Inductosyn are called the scale and the slider, respectively.

# HOW TO SELECT AND USE INDUCTOSYN POSITION TRANSDUCERS

The information on pages 6-8 will help you select the right Inductosyn transducer for your application. Inductosyn transducer specifications plus recommended mounting and installation procedures are presented on pages 9-13. To select a standard unit or specify a modified or special design, application engineers at Farrand are ready to support you.

## ROTARY INDUCTOSYN TRANSDUCERS

Rotary Inductosyn rotor and stator elements are normally supplied as separate units for direct attachment to your equipment's shaft and support. See Figure 4. Mounting surfaces are easily prepared; assembly is simple. Thus, coupling errors are eliminated. Tables 1 and 2 on page 11 list representative incremental and absolute rotary Inductosyn transducers.

Standard outside diameters range from 3 to 16 inches. Larger diameters generally provide greater accuracy and allow larger center clearance openings. Excitation and output signal levels are not a direct function of diameter.

Sine and cosine windings are placed on the stator to permit direct connections. Rotor connections can be made with flexible leads if rotation is restricted. Slip ring or rotary transformer options allow unlimited rotation.

Complete rotary assemblies with integral bearings and couplings can be supplied on a special order basis. Due to external shaft coupling error, accuracy may be less than the identical rotor/stator combination would provide if directly mounted.

## LINEAR INDUCTOSYN TRANSDUCERS

A linear Inductosyn transducer consists of a scale and a slider. See Figure 5. Table 3 on page 12 lists representative linear Inductosyn transducers. Scales are supplied as rigid bars and

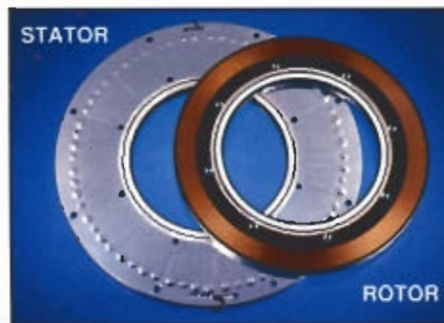

FIGURE 4 Rotary Inductosyn Transducer



FIGURE 5 Linear Inductosyn Transducer

continuous tapes. Modular bar scales in two different widths are supplied in lengths of 10 inches, 254 mm, 252 mm, or 250 mm depending on cyclic pitch. These scales can be mounted end to end to form continuous measuring systems of unlimited length or they may be cut shorter at the factory to meet clearance restrictions.

Tape scales are mounted in tension to provide economical, easily installed one piece scales. Lengths to 120 feet (36.6m) or more can be supplied. They can be mounted horizontally or vertically. Factory calibration is duplicated easily without special tools or length standards.

Adjustable Linear Inductosyn Scales are one piece bars that can be adjusted after installation to virtually eliminate errors over their full length, limited only by the accuracy of the user's primary length standard and readout resolution. Individual lengths to 72 inches (1829 mm) are supplied. Two lengths can be used to provide a total length to 144 inches (3658 mm).

All three types of linear scale elements may be installed directly

as components in the user's machine. Tape scales and modular bar scales are also supplied as complete, enclosed assemblies called spars. Accuracy of spars is identical to separately mounted components. Spar slider mounts extend through flexible sealing lips for direct attachment to moveable machine parts.

Scales may also be supplied in cassette form, with the slider mounted on an internal sliding support rod that can be coupled externally to moveable parts. These units are suitable for extreme industrial environments, for example, metal rolling mills.

## SELECTION TRADEOFFS

**Accuracy** - Choose rotary diameter and linear scale type or width to satisfy accuracy needed or mounting restrictions. Specially selected units can provide greater than standard accuracy. Highest linear accuracy is possible with Adjustable Linear Scales.

**Cycle length** - Select cycle length to suit your system requirements. Accuracy is not strictly a function of cyclic pitch. Standard linear cyclic pitches measure 0.1 inch, 0.2 inch, and 2 mm. Standard rotary units incorporate from 2 to 2048 poles.

**Travel and overall length** - Before Inductosyn selection, determine travel and overall length required. For tape units, allow for overtravel to clear tape tension supports. For bar scales, this is not a consideration, as they are free of mechanical interference at their ends.

**Standard material** - Bar scale, slider, and rotary unit substrates are precision ground plates of hot rolled steel or aluminum, closely matching thermal coefficients of most machine parts. Almost any other substrate material can be supplied on special order. Tape scale substrates are offered in spring steel, stainless steel, or aluminum.

## HOW TO USE INDUCTOSYN POSITION TRANSDUCERS

Inductosyn position transducers may be used in any way that an ordinary resolver is used. The output signals may be used directly or amplified in analog servo systems.

Like a resolver, the sine and cosine windings of an Inductosyn transducer may be excited with in-phase carrier voltages proportional to the sine and cosine of the complement of a desired position in the pitch cycle. When the rotor or slider is positioned so that its output voltage is zero, the desired position will have been achieved. Usually, the analog output signals are digitized by one of the many types of analog to digital converters used with resolvers or Inductosyn transducers. See Figure 6. These converters use one of the following methods to convert the analog signal to highly accurate digital data.

1. Ratiometric comparison of sine and cosine output signals. (Rotor or scale excitation).
2. Amplitude measurement or nulling of error output signal. (Amplitude modulated excitation of sine and cosine).
3. Phase shift measurement of error output signal. (Time quadrature excitation of sine and cosine).

Many sources, including Farrand, offer analog to digital converters. In addition, many machine tool numerical controls include the analog to digital conversion circuits as a standard or optional feature.

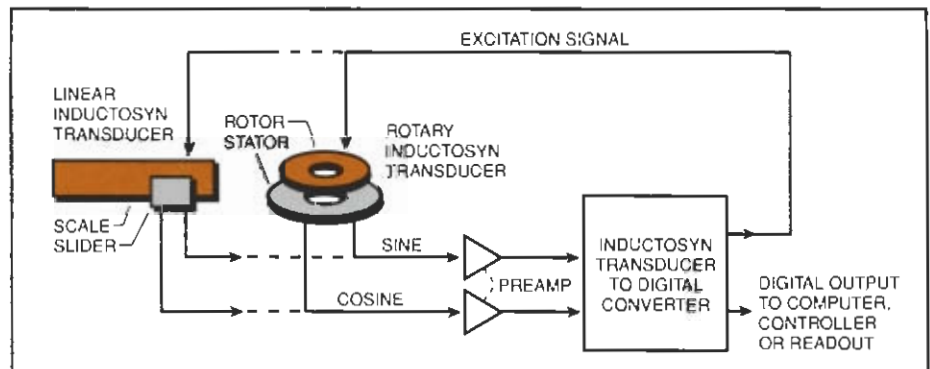

FIGURE 6 Typical Inductosyn Transducer to Digital Output Subsystem

## ELECTRICAL CHARACTERISTICS

Winding impedance is approximately inversely proportional to cycle length, and varies directly with scale length or rotor diameter. Voltage transformation ratio (VTR) is independent of scale length when the slider is excited. Direct, slip ring, or rotary transformer coupling may be specified for rotary units. Transformers will change the VTR and impedance for otherwise similar units.

Specified at a carrier frequency of 10 kHz, Inductosyn units have been operated at frequencies from 200 Hz to 200 kHz. Recommended operating range for most units is 2.5 kHz to 100 kHz. Output or error signal voltage is directly proportional to carrier frequency. Maximum error signals range typically from 1 to 100 mV, with 2 volt excitation at 10 kHz.

Farrand supplies electronic interface components, ranging from error signal amplifiers to complete Inductosyn-to-digital converters and digital displays. Representative accessories are discussed on page 14. For more information on our high speed Inductosyn-to-digital converters, request our brochure. These units

generate the Inductosyn excitation signal and subdivide each Inductosyn cycle into a number of steps ranging from less than 100 to 65,536. Inductosyn-to-digital converters provide position data signals to counters, computers, and digital readout equipment.

## ELECTRICAL SOURCES OF ERROR

No coupling can be allowed between rotor and stator (scale and slider) circuits except for the inductive coupling provided by the Inductosyn windings. To minimize extraneous coupling, stators and sliders have an electrostatic shield applied over the windings. This shield must not be removed, and should be grounded directly through the mounting bolts.

Shielded cables with very tightly twisted pairs, layouts with good separation between cables, and the use of magnetic shielding sleeves on output signal cables will reduce stray coupling to acceptable levels. Cable shields must be insulated from each other, and carried independently through connectors, to be grounded at one common point in the system. Farrand stocks appropriate cables and magnetic shielding materials.



# HOW TO SELECT AND USE INDUCTOSYN POSITION TRANSDUCERS

*continued...*

## **MOUNTING REQUIREMENTS AND MECHANICAL ERRORS**

The averaging properties of Inductosyn devices make high accuracies achievable with realistic tolerances. Inductosyn elements may be installed and adjusted by machinists, inspectors, or engineers experienced with precision mechanisms and the use of gage blocks or laser interferometers. Factory assistance is always available.

Rotors and stators have open centers, and may be mounted on shaft flanges, hubs, and other flat surfaces.

The Inductosyn conductor pattern is concentric with the O.D., which should be centered on the axis of rotation to .0002" T.I.R. to achieve rated accuracy. Rotary Inductosyn transducers will still operate at high but slightly degraded accuracy even if mounted with a significant amount of eccentricity. Resolution is unaffected by eccentricity. This capability allows Inductosyn transducers to be used where other types of position transducers would be impractical.

Additional decentering of one or both plates with respect to the axis of rotation will result in increased accuracy error. The nature of this increased error will be a once per mechanical revolution error, i.e. the error cycle will cover one mechanical revolution. The magnitude of the error increase is dependent on the amount of decentering, the size of the transducer, and the number of poles in the transducer's pattern. In general, a larger diameter unit will be less sensitive to decentering than a smaller unit of the same pole count. For units of the same size, a unit with fewer poles will be less sensitive to decentering than a unit with a greater number of poles. Decentering sensitivity data for specific units is available from the factory upon request. Bar scales must be mounted on a surface that is ground flat to provide an assembled air gap variation of less than .001" scale to scale, and .002" overall. Skew between scale edge

and axis of motion must be less than .002" T.I.R.

Spar assemblies can provide the required mounting plate for 10" bars. The spar assembly must be attached to the machine at 10" intervals for rigidity. Farrand supplies adjustable spherical mounts to mount spars on uneven surfaces. Tape scales and tape spars require rigid support only at the ends. Tape scales can also be wrapped on cylindrical surfaces to provide angular feedback for very large rotational axes.

Air gaps of most linear and rotary units may be set between .005" and .015". Accuracy is not directly affected by spacing, but variations of VTR due to wobble or change of spacing will change the output signal amplitude. Departures from parallelism should be held to 10% of the air gap. We recommend that mechanical non-repeatability, inconsistent with the measuring task, be eliminated.

## **SPECIAL OPTIONS TO MEET SPECIAL REQUIREMENTS**

Bar scales, sliders, and rotary units may be manufactured on other substrates, e.g. stainless steel or beryllium, and in nonstandard thicknesses, diameters, or mounting configurations. Subject to size and configuration limitations and material compatibility, Inductosyn patterns may be produced directly on user's parts. Units with special output signals, for example, once per revolution markers, can also be supplied.

## **CAPACITIVELY COUPLED UNITS**

Farrand can also supply capacitively coupled units that employ the same general operating principles as inductively coupled units. These units, relying solely on capacitive coupling between the two elements, are generally immune to the effects of unavoidable, large sources of magnetic disturbance. Capacitively coupled units are advantageous in situations

where a very fine pitch is desirable or if special auxiliary signals are needed. Typical applications have included computer peripheral devices, for example disk drives and printers, as well as other compact precision mechanisms. Consult with our applications engineering staff to decide if a capacitively coupled unit is a good choice for your application.

## **SPECIAL INDUCTOSYN PACKAGING**

Most Inductosyn transducers are supplied as frameless direct mount elements. This configuration is more practical for Inductosyn transducers than for other high accuracy, high resolution position transducers due to the unique Inductosyn operating principle and their rugged design and construction. There are, however, applications where housed units are desirable. Applications that require rapid field replacement or protection from weather or environmental extremes are often candidates for housed or semi-housed units. Housed rotary units have been supplied for applications including antenna encoding systems, submarine inertial navigation systems, and machine tool rotary tables.

Several standard types of housed and semi-housed linear units are available. Typical applications include machine tools or industrial automation. Fully housed linear "cassette" assemblies that combine extreme ruggedness with high precision are very popular for automatic gage control systems in rolling mills. Semi-housed "spar" assemblies for tape scales and bar scales are often used for machine tool applications because they combine easy mounting with covers and lip seals that exclude machining debris. Please refer to the linear section for more information on standard cassette and spar assemblies.

Special linear or rotary packaging requirements can be discussed with our engineering staff.



# ROTARY INDUCTOSYN TRANSDUCERS

## ROTARY INDUCTOSYN TRANSDUCERS

Farrand manufactures incremental and absolute rotary Inductosyn transducers in a large selection of sizes, angular pitches, substrate materials, and output formats. See Figures 7 and 8 and Tables 1 and 2. These units are used in incremental and absolute measurement systems. They feature popular options, for example, integral rotary transformers, slip ring assemblies, once-per-revolution marker signals, and special materials to meet harsh environments.

Rotary Inductosyn transducers, as a result of their unique design, operating principle, and construction, tolerate mechanical misalignment and environmental extremes. The rotor and stator elements can be directly mounted to the axis of rotation, eliminating additional bearings, housing, shaft, and coupling. Direct mounting also reduces weight, bulk, and error.

Rotary Inductosyn transducers offer advantages that result from a design and operating principle which incorporates 360 degree averaging of rotor and stator patterns. In addition, the design and construction yield a monolithic structure for each element that is highly reliable and insensitive to temperature extremes and temperature gradients. With minor changes to coating and potting materials, the rotary Inductosyn's stable structure makes it possible to produce units that provide high accuracy position information while withstanding conditions ranging from cryogenic temperatures and hard vacuum to high temperatures and pressures. These units also withstand industrial contaminants and various types of high radiation.

Farrand manufactures rotary Inductosyn transducers with outside diameters from less than 2 inches to 42 inches. Pole counts vary from 2, ( $360^\circ$  angular pitch), to 2160, ( $0.333^\circ$  angular pitch). Every pole count is not



**FIGURE 7** *Incremental Rotary Inductosyn Transducer*

available in every size, but an almost endless variety is available as either standard or special order units. Farrand supplies wrapped tape systems when high accuracy position data is needed for very large diameters.

Almost any material can be the substrate material provided it is stable and consistent with other requirements of the application. The most common materials are aluminum and low carbon, hot rolled steel. Other substrate materials that have been used are stainless steel, beryllium, titanium, magnesium, glass, ceramics, and plastics. The substrate material is usually selected to be compatible with the structure of the measuring system or to meet the application's environmental requirements.



**FIGURE 8** *Absolute Rotary Inductosyn Transducer*

# ROTARY INDUCTOSYN TRANSDUCERS

continued...

Farrand offers, as an option, an integral rotary transformer on most standard 7 inch and 12 inch outside diameter rotary Inductosyn units. Where size permits, this feature can be incorporated in almost any unit. Separate rotary transformers are available for units that cannot accommodate an integral rotary transformer. Rotary transformers, integral or separate, allow continuous rotation of the rotor without the need for slip rings.

The rotary transformer, whether integral or separate, should be specifically designed for the excitation frequency and mode (rotor or stator excited) that will be employed. Therefore, these details should be supplied to ensure compatibility. Many 7 and 12 inch outside diameter rotary Inductosyn units can be supplied with integral slip ring assemblies.

Other popular options include once-per-revolution marker signals, alternate lead length or material, electrical centering harness, and "Select" accuracy Inductosyn units. Once-per-revolution markers are sometimes added to incremental units if space permits. This is usually done with a Hall effect switch in the stator activated by a magnet array in the rotor. Alternate lead lengths and materials compatible with the application can be supplied for almost any situation. A popular option is the use of terminal pins to allow leads to be easily changed or replaced.

For the highest accuracy applications, a popular option is an electrical centering harness. This option allows the stator harness to be temporarily altered in order to check and adjust proper mechanical alignment of rotor and stator. For higher accuracy applications, Select accuracy units can be supplied. Rotary Inductosyns with Select accuracy are available only when they are produced in sufficient quantities to allow this selection.

## INCREMENTAL ROTARY INDUCTOSYN TRANSDUCERS

All Inductosyn position transducers can be considered absolute if used within a span of one electrical cycle. The reason is that an absolute representation of any position within that cycle can be determined. For Inductosyn transducers that have only one pattern, with a large number of electrical cycles, the absolute measurement span is quite small. Typically, these units are used to provide incremental position data.

Rotary Inductosyn position transducers which provide incremental position data are usually combined with analog to digital conversion electronics to provide an incremental data output format. Farrand offers conversion electronics, including our I/D Quad and CVU converter series described in the Accessories section. The Accessories section also discusses complete digital readout assemblies that can be used with these transducers. In certain situations a parallel binary representation of cyclic position is more desirable. The 219060 series of conversion electronics, described in the Accessories section, provides this output.

Table 1 lists representative incremental mode units. For information on additional units, please contact our applications engineering staff.

## ABSOLUTE ROTARY INDUCTOSYN TRANSDUCERS

Inductosyn position transducers provide absolute position data if the required range of absolute measurement is less than one electrical cycle. Often, the range of absolute measurement must be a full revolution, 360°, or a significant portion of the revolution. Transducers with only one or two electrical cycles per revolution are not capable of providing

high accuracy or high resolution; therefore, the solution is to incorporate multiple patterns on one unit.

There are two common design approaches for these units. The first, combines a coarse one cycle pattern with a fine multi-cycle pattern. The outputs of each pattern are digitized and combined in synchronization or "correlation" logic to provide an output that is both accurate and absolute.

The second approach, illustrated in Figure 9, uses an N/N-1 method which features two multi-cycle patterns that differ by one cycle over the range of absolute measurement. The outputs of these two patterns are digitized and subtracted. The result of this subtraction is digital coarse data which is then combined with one of the digitized fine outputs to provide an output that is again accurate and absolute.

Almost any Inductosyn transducer can be combined with a coarse transducer, for example, a wire wound resolver to form an absolute measurement system. Table 2 does not cover such systems but instead lists representative absolute rotary transducers.

Farrand supplies electronics, described in the Accessories section, to provide the absolute digital output.

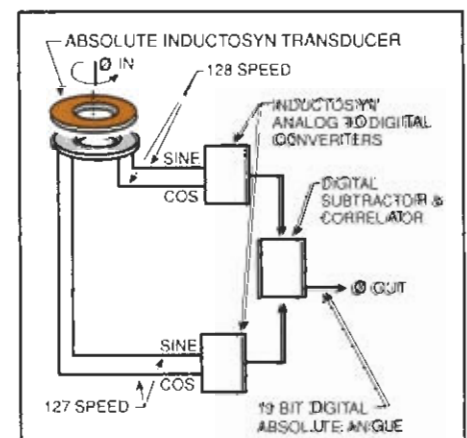
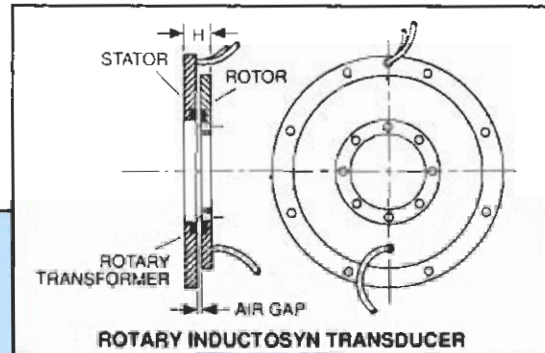

FIGURE 9  
Absolute Inductosyn Transducer output





The following chart represents a sampling of the many INDUCTOSYN rotary stators and rotors available. Some units are available with selected higher accuracies. Detailed specifications are available upon request.

### INCREMENTAL ROTARY

SIZE (Notes 1 and 2)		STANDARD ACCURACY arc second	POLES/ SPEED	H (Note 3)	VTR ±20% (Note 4) rotor exc.	AIR GAP inches	RESISTANCE ±20%		MATERIAL	INTEGRAL ROTARY TRANSFORMER
STATOR O.D. inches	ROTOR I.D. inches						STATOR Ohms	ROTOR Ohms		
3.7	0.61	±4.0	360/180	0.50	1750	0.006	3.7	3.4	AL	No
4.0	1.40	±3.0	512/256	0.50	3400	0.006	12.0	9.0	AL	No
3.8	1.08	±10.0	100/50	0.63	4800	0.006	0.5	4.0 (XFMR)	AL	Yes
3.0	1.31	±8.0	256/128	0.51	650	0.004	1.6	1.8	AL	No
3.0	0.88	±15.0	128/64	0.50	360	0.006	0.38	0.45	AL	No
7.0	1.50	±3.0	360/180	0.64	480	0.006	2.7	1.3 (XFMR)	HRS	Yes
7.0	1.50	±2.0	720/360	0.64	2800	0.006	7.0	4.0 (XFMR)	HRS	Yes
7.0	1.50	±2.0	512/256	0.64	2500	0.006	3.7	3.7 (XFMR)	AL	Yes
7.0	3.25	±2.0	512/256	0.64	350	0.006	3.7	4.1	HRS	No
7.0	1.50	±3.0	256/128	0.64	2425	0.006	1.0	3.5 (XFMR)	HRS	Yes
12.0	2.50	±1.5	360/180	0.75	406	0.008	4.6	3.9 (XFMR)	HRS	Yes
12.0	2.50	±1.0	720/360	0.75	1400	0.008	5.0	3.9 (XFMR)	HRS	Yes
12.0	6.00	±2.0	512/256	0.75	1100	0.008	3.5	6.0 (XFMR)	HRS	Yes
12.0	6.00	±3.0	256/128	0.75	20	0.008	1.2	0.9	HRS	No
12.0	6.00	±1.0	1024/512	0.75	3000	0.008	12.5	8.4 (XFMR)	HRS	Yes
12.0	2.50	±2.0	2000/1000	0.75	4100	0.008	45	55	HRS	No
14.0	9.25	±1.0	720/360	1.00	720	0.008	4.5	3.0 (XFMR)	HRS	Yes
14.0	9.25	±2.0	1000/500	1.00	760	0.008	5.9	2.5 (XFMR)	HRS	Yes
16.0	11.00	±1.0	1024/512	1.00	450	0.008	6.0	2.6 (XFMR)	HRS	Yes

TABLE 1

### ABSOLUTE ROTARY

SIZE (Notes 1 and 2)		STANDARD ACCURACY		POLES/ SPEED 2 patterns	H (Note 3)	VTR ±20% (Note 4)		AIR GAP inches	RESISTANCE ±20%			
STATOR O.D. inches	ROTOR I.D. inches	FINE arc sec	COARSE arc sec or min			FINE rotor exc.	COARSE rotor exc.		STATOR		ROTOR	
							Fine Ohms	Coarse Ohms	Fine Ohms	Coarse Ohms		
4.16	0.95	±5	±20 min	256 : 2 128 : 1	0.35	260	1450	0.006	1.5	0.6 ±.2	1.4	2.1
5.00	0.814	±10	±10 sec	128 : 126 64 : 63	0.50	167	194	0.008	0.63	0.49	0.42	0.47
3.00	0.375	±15	±45 min	128 : 2 64 : 1	0.41	460	240	0.006	0.25 ±.1	0.4 ±.1	0.3 ±.1	0.45 ±.1
8.50 (XFMR)	2.125 (XFMR)	±6	±10 sec	256 : 254 128 : 127	0.75	4500	4500	0.008	1.3	1.2	4.0 (XFMR)	
8.2	3.155	±5	±30 min	256 : 2 128 : 1	0.75	100	500	0.008	0.8	0.4	0.8	3.5
8.5	2.562	±1.7	±2.7 sec	512 : 504 256 : 252	0.75	390	800	0.008	1.4	1.7	1.9	2.6
11.0	6.000	±6.5	±12.5 sec	256 : 254 128 : 127	0.76	117	121	0.008	1.5	1.3	0.8	0.9
12.3	5.250	±1.7	±2.0 sec	512 : 504 256 : 252	0.75	152	212	0.008	1.4	1.4	1.5	1.8

TABLE 2

**Notes:**

- Standard rotor connections are made by direct wiring or integral rotary transformers. Long life slip rings are available on special order.
- Outside diameter is concentric with INDUCTOSYN conductor pattern for alignment.

- Overall installed height of standard unit, not including leads or terminals.
- Voltage Transformation Ratio (VTR) is the ratio of input voltage to maximum open circuit output voltage, measured at 10 KHz with the specified air gap. Output voltage increases directly as

frequency increases. Operation at carrier frequencies above 100 kHz or below 2.5 kHz is not recommended.

# LINEAR INDUCTOSYN TRANSDUCERS

Farrand manufactures linear Inductosyn transducers in several forms and in a variety of cyclic pitches and substrate materials. Table 3 illustrates representative Inductosyn transducer units. As a result of the simple rugged construction of linear Inductosyn transducers, they can withstand almost any environmental extreme, similar to those described in the rotary transducers' section.

**FIGURE 10**  
Linear Inductosyn  
Transducer



### TAPE SCALE SPAR

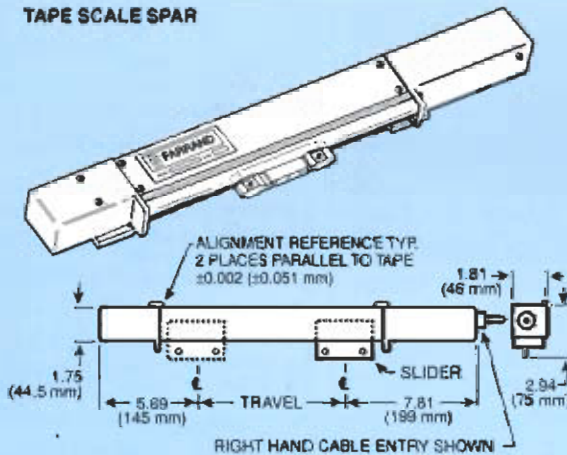

### BAR SCALES

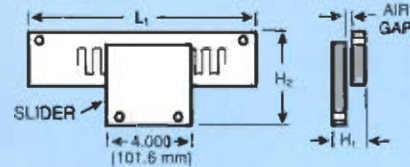

### TAPE SCALES

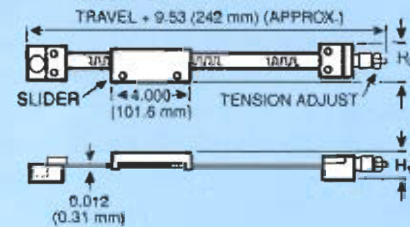

The following chart represents a sampling of the many INDUCTOSYN linear scales and sliders available. Some units are available with selected higher accuracies. Detailed specifications are available upon request.

L <sub>1</sub> (Nom.) SCALE LENGTH (Note 1)	STANDARD ACCURACY	CYCLE LENGTH	TYPE (Notes 2,3)	H <sub>1</sub> (Note 4)	H <sub>2</sub>	VTR @ 10 kHz (Note 6)	AIR GAP	RESISTANCE OHMS (±20%)	
								SCALE	SLIDER
<b>LINEAR INDUCTOSYN TRANSDUCERS WITH INCH PITCH - ALL DIMENSIONS IN INCHES, UNLESS NOTED</b>									
10.0	±0.0001	0.1 in	Wide	0.762	3.480	60	0.007	3.0	1.4
10.0	±0.0001	0.2 in	Wide	0.762	3.480	25	0.007	0.80	0.50
10.0	±0.0001	0.1 in	Narrow	0.762	1.866	90	0.0075	1.20	0.75
10.0	±0.0002	0.2 in	Narrow	0.762	1.866	40	0.0075	0.40	0.32
Ta 120 feet	(Note 2)	0.1 in	Tape	1.235	1.825	85	0.007	2.1/ft.	0.75
Ta 120 feet	(Note 2)	0.2 in	Tape	1.235	1.825	45	0.007	0.75/ft.	0.30
120.0	(Note 5)	0.1 in	Adjust	0.700	1.466	155	0.0075	1.2/ft.	1.0
<b>LINEAR INDUCTOSYN TRANSDUCERS WITH METRIC PITCH - ALL DIMENSIONS IN MILLIMETERS, UNLESS NOTED</b>									
250	±0.0025	2 mm	Wide	19.4	88.4	85	0.178	4.5	1.8
250	±0.0025	2 mm	Narrow	19.4	47.9	130	0.178	2.5	0.9
Ta 36 m	(Note 2)	2 mm	Tape	31.4	46.2	160	0.178	9.93/m	1.2
Ta 3.05 m	(Note 5)	2 mm	Adjust	17.8	37.3	175	0.190	5.4/m	0.9

**TABLE 3**

#### Notes:

- Total length required in bar scale installations equals total travel plus length of slider or combine individual 10 inch or 250 mm scales as required. Can be cut to customer specified length.
- Accuracy of bar scales is stated for 1 scale length, non-accumulative. Accuracy of tape scales is 0.0001 inch/foot T.I.R. (0.0025 mm/300 mm T.I.R.).
- Standard material for all bars and sliders is hot rolled steel (H.R.S.). Standard material for tape scales is spring steel.
- Overall installed height of standard unit, not including leads or terminals.
- Errors can be reduced virtually to zero, limited by user's primary standard and readout resolution.
- Measured with slider excited.



The common forms of linear scales are modular bar scales, continuous tape scales, and adjustable scales.

Bar scale arrays are used to form measuring systems of any length. See Figure 10. Continuous tape scales provide highly accurate, cost effective position feedback for travel to 120 feet or greater. See Figure 11. Adjustable scales provide position feedback measurements rivaling the results of laser interferometers at lower cost and complexity. See Figure 12. Adjustable scales are also offered with protective covers including lip seals.

Bar scales, typically produced on hot rolled steel substrates, can be manufactured on an almost limitless variety of materials to match any thermal coefficient. Representative substrate materials include aluminum, stainless steel, Invar, ceramics, glass, and plastics. Substrates for tape scales include the standard, clock spring steel, plus, as required, stainless steel and aluminum. Hot rolled steel is the standard substrate for adjustable scales; however, many other special order materials are offered.

The scale systems described here are mounted directly to the machine elements. Farrand also manufactures semi-housed tape scale "spar" units with protective covers and lip seals. See Figure 13. Spar units are also available for bar scales as are fully enclosed "cassette" units. See Figure 14. Cassette units are popular for the most extreme industrial environments, for example, basic metal rolling mills.

Linear Inductosyn transducer accessories, for example, analog to digital converters and complete readout systems are described in the Accessories section. Please contact our applications engineering staff, for information on additional units, including absolute linear transducers.



FIGURE 11 *Tape Scale*



FIGURE 12 *Adjustable Scale*



FIGURE 13 *Tape Spar*



FIGURE 14 *Cassette*

Tape scales provide economical, easily installed one piece scales. They can be mounted horizontally or vertically to obtain information on hard to measure travel lengths in long bed metal cutting.

Adjustable scales are one piece bars that can be adjusted after installation to virtually eliminate errors over their full length, limited only by the accuracy and structural integrity of the user's measurement equipment.

Tape Spars are completely enclosed scale assemblies installed directly as a component in the user's machine. Spar slider mounts extend through flexible sealing lips for direct attachment to moveable machine parts.

Fully enclosed cassette units are available for bar scales. These units can be pressurized through a purge fitting to help prevent contamination from external sources.

# ACCESSORIES

## ACCESSORIES

Farrand manufactures many items to simplify integrating Inductosyn position transducers into your system. These include analog-to-digital converters, preamplifiers, correlation logic assemblies used with absolute transducers, and two types of digital readout assemblies.

Other accessories include electrical wiring and shielding materials specifically designed for high accuracy analog-to-digital conversion systems, matching transformers, separate rotary transformers, and mechanical mounting aids.

## ANALOG TO DIGITAL CONVERTERS

Farrand's A/D converters provide digital position data in several serial or parallel data formats in a range of resolutions. These converters include the necessary reference oscillator. When combined with an appropriate preamplifier and power supplies, the converters provide digital position data to computers, numeric control systems, position display systems, and motion control systems. See Figure 15.

Farrand's Series 219060 converters provide parallel binary format position data. The Series 219100 converters (Inductosyn-to-Digital Quad) provide serial incremental data in formats that include quadrature square waves, count up-count down, and counting pulses with an up-down signal level. See Figure 16.

Model CVU converters provide outputs similar to the Series 219100; however, they are specially designed for applications requiring higher speeds and accelerations at lower resolutions. A new series of multi-axis, absolute conversion products will be available soon. For information on these converters, please contact our applications engineering staff.

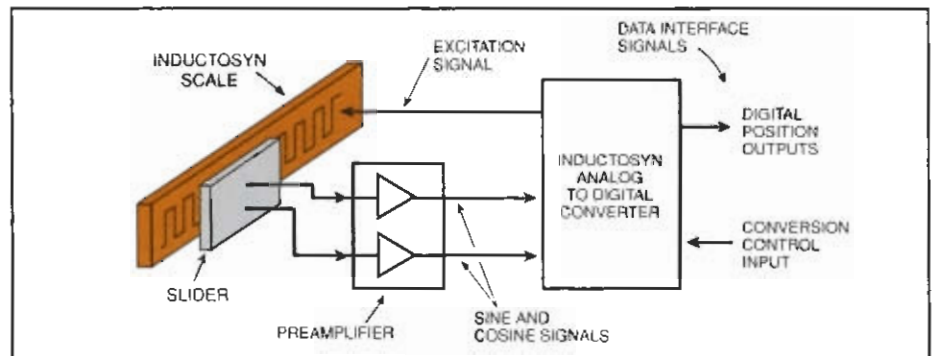

FIGURE 15 Analog to Digital Converters

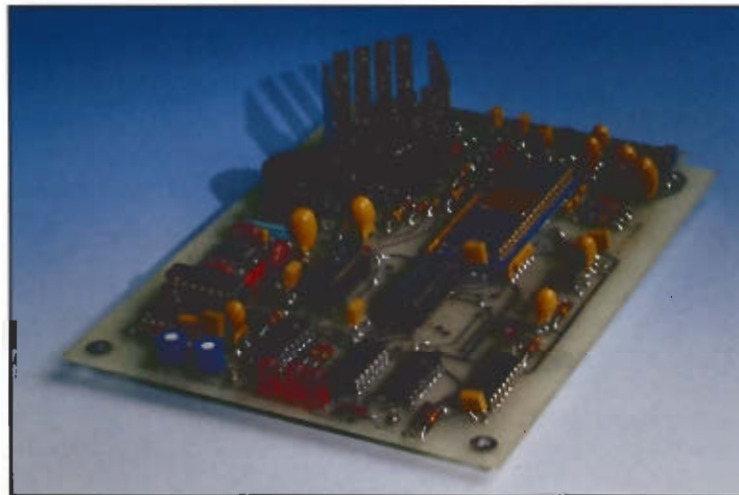

FIGURE 16 Quad Converter

## PREAMPLIFIERS

The Inductosyn transducer's output signal amplitude requires that an appropriate gain preamplifier be added. Farrand manufactures preamplifiers for Inductosyn transducer and converter systems. Please request additional information.

## DIGITAL READOUT ASSEMBLIES

Farrand offers two complete series of digital readout assemblies for linear and rotary Inductosyn transducers. Each assembly consists of all components needed to provide digital position representation from an Inductosyn transducer and preamplifier including the converter, oscillator, logic, counters, display, and power supplies. Please request information on our model CVN and CVU readout systems.

## CORRELATION LOGIC ASSEMBLIES

A correlation logic assembly combines the coarse and fine or N and N-1 digital position information of absolute position transducers. The output of the correlation logic assembly is a parallel binary word representing the absolute position of the transducer. Farrand offers the Series 218956 correlation logic assemblies to utilize the outputs of most common pattern combinations.

## SPECIAL AND CUSTOM PRODUCTS

Farrand welcomes your requests for accessories or electronic subsystems for custom applications. Please contact our sales representatives or our applications engineering staff for immediate attention to your requirement.



# APPLICATIONS

## AUTOMATION AND SCIENTIFIC APPLICATIONS

Inductosyn transducers have been used on virtually every moving axis on every type of machine tool. It is common to find a rebuilt machine tool with a new digital readout or numerical control system that utilizes the original linear and rotary Inductosyn scales installed 20 or even 30 years ago. Other industrial automation applications include automatic gauge control systems for rolling mills, precision robotics, and special test or calibration systems.



**FIGURE 17** Gimbal mounted infrared scanner uses Inductosyn transducers to provide very accurate position information.

## MILITARY AND AEROSPACE APPLICATIONS

In military and aerospace applications, Inductosyn transducers are among the most widely used position transducers. Three extremely important characteristics for military/aerospace applications are insensitivity to temperature effects, the ability to be directly mounted onto a variety of substrate materials, and high reliability. Other important characteristics are resistance to shock, vibration, temperature extremes, high pressure, and hard vacuum, plus continuous operation after exposure to contaminants such as oils, liquids, dust, dirt, and salt spray.

Examples of Inductosyn transducers specially designed for military and aerospace applications include:

- Airborne infrared scanners
- Airborne side looking radar antennae
- Calibration and test standards
- Cryogenic chambers
- Ground surveillance radar antennae
- Inertial navigation systems for submarine and surface vessels
- Land mobile target acquisition and tracking systems
- Large celestial telescopes
- Motion simulators



**FIGURE 19** The Rapier uses Inductosyn transducers to transmit target tracking and missile launch angles.

- Optical tracking systems for firing ranges
- Rate tables
- Satellite communication ground station antennae
- Ship borne target acquisition and tracking systems
- Space flight qualified robotic arms
- Space flight qualified satellite gimbal systems
- Space flight qualified scanner mechanisms
- Vacuum chambers

Farrand Controls thanks the following for allowing use of photos on this page.

**FIGURE 17** British Aerospace  
Naval and Electronics Systems  
Bracknell  
Berks, England

**FIGURE 18** The Product Machine Company  
Machine Tool Division  
Bridgeport, Connecticut

**FIGURE 19** British Aerospace  
Army Weapons Division  
Stevenage  
Herts, England

**FIGURE 18** Rotary Jig Borer incorporates rotary and linear Inductosyn transducers to achieve positioning accuracies of  $\pm 3$  arc second and  $\pm 0.0002$  inch.

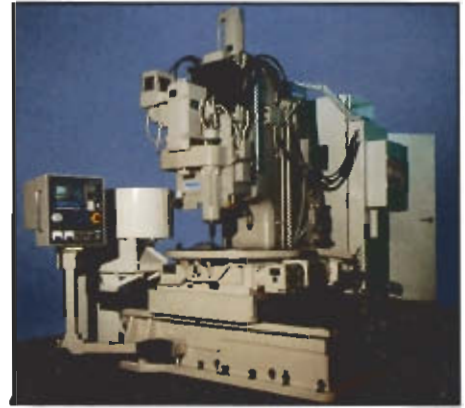

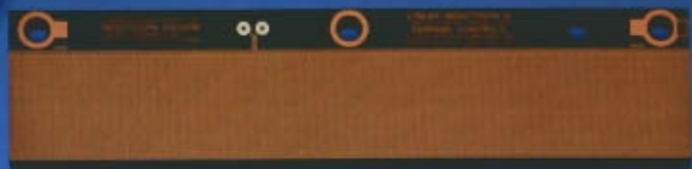
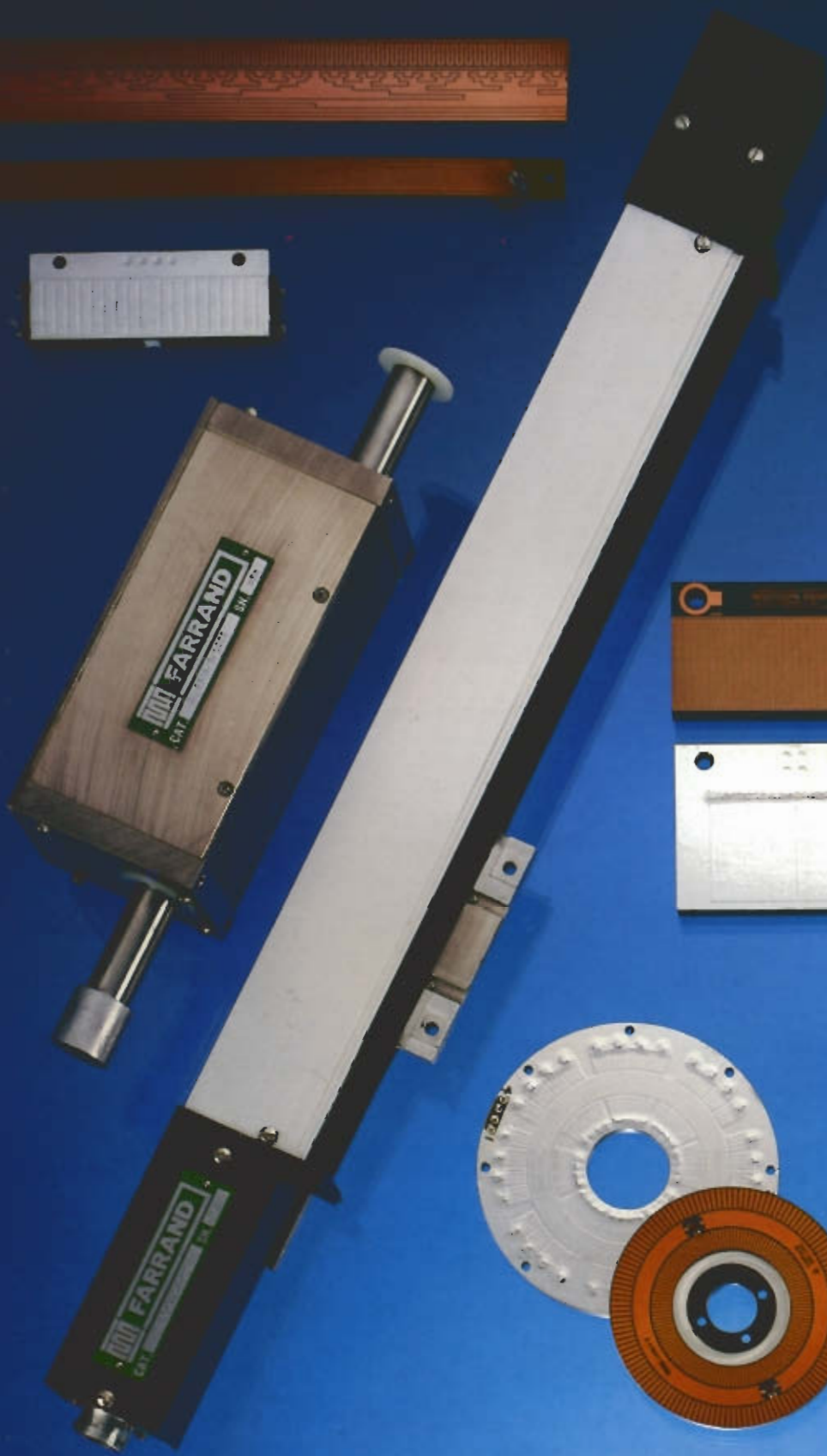

**FARRAND CONTROLS**

Division of Ruhle Companies, Inc.  
99 Wall Street, Valhalla, NY 10595-1447  
TEL: 914/761-2600 FAX: 914/761-0405

**INDUCTOSYN INTERNATIONAL®**

Division of Ruhle Companies, Inc.  
99 Wall Street, Valhalla, NY 10595-1447 USA  
TEL: 914/761-2600 FAX: 914/761-0405