

# LATEST PRODUCTS CORP.

P.O. BOX 190 SYOSSET, NY 11791 1-800-288-3547



2011-2012 CATALOG



**Your one-stop shop for high-quality products at the lowest prices!**

Now celebrating our 40th year in business...

serving thousands of hospitals, nursing homes, assisted living facilities, correctional institutions, hotels, universities, commercial institutions and government agencies. These businesses count on Latest Products for quality, reliability and price savings.



LAUNDRY BAGS

HAMPERSTANDS

CART COVERS

UTILITY CARTS

PILLOWS

LINEN CARTS

PVC CARTS

HEAT DYE TRANSFERS

TRANSPORT TRUCKS

BED BUG PROTECTION

AND MUCH MORE!

**WWW.LATESTPRODUCTS.NET 1-800-288-3547**



For additional products not shown visit us at [www.LatestProducts.net](http://www.LatestProducts.net).





Bag Holders/Caddies.....	19
Bed Bug Protection.....	8
Buckets.....	68
Canvas Utility Carts.....	38, 42
Cart Covers.....	10-11
Cart Liners/Cover Caps.....	9, 39
Closed Case Carts-Stainless.....	89
Commodes.....	83-85
Cubicle Curtains.....	20
Dolly Trucks.....	45
Dump Trucks.....	68
Dunnage Racks.....	59-60
Emblems.....	2, 22
Extractor Trucks.....	41
Flatwork Ironer Trucks.....	41
Floor Signs.....	82
Garment Racks.....	81
Hamper Caps.....	9
Hamperstands.....	12-18
Heat Dye Transfers.....	26
Heat Sealable Patches.....	22-23
Heat Sealing Machines.....	24-25
Housekeeping & Maid Carts.....	64-67
Impervious Laundry Bags.....	3
Inhalation Cart.....	46
Isolation Room Carts/Accessories.....	93
IV Poles.....	86-88
IV Transport Cart.....	46
Janitor Carts.....	64-65, 67
Laundry Bags.....	3-7, 9
Laundry Bag Accessories.....	7
Laundry Hamperstands.....	12-18
Laundry/Linen Truck Accessories.....	28
Laundry Linen Trucks.....	27-44
Laundry Net Bags.....	6-7
Laundry Truck Liners/Caps.....	9, 39
Linen Exchange Carts.....	32-36
Linen Trucks-Aluminum.....	43-44, 46
Liners / Basket, Replacement.....	9, 39
Lockable Wood Covered Hamper Trucks.....	42
Marking Systems.....	22
Microban Stern Caster Carts.....	52
MRI Room Hampers.....	13
Net Bags.....	6-7
Patches / Patching Material.....	2, 22-23
Patient Privacy Screens.....	79
Patient Room Tables.....	79
Pillows.....	21
Pillow Storage / Transport Cart.....	94
Polyethylene Multipurpose Carts.....	15, 40
PVC Clean Linen Carts.....	51
PVC Hamperstands.....	18
PVC Nurse Aid Carts.....	50
Recycling Cart.....	66
Recycling Receptacles.....	69, 78, 91
Replacement Basket Liners.....	39
Round Tripper Linen Trucks.....	33-35
Scales - Laundry.....	80
Secure Document Containers.....	92
Security Units/Carts.....	32, 35-36, 47, 92
Slanted Shelf Carts.....	45
Sheet Feed Trucks.....	41
Shelving Units.....	54-56
Shelving Accessories.....	61-63
Shower Chairs/Commodes.....	83-85
Smokers Receptacles.....	77
Spring Platforms.....	38, 42
Stern Caster Carts.....	45, 52
Step-On Cans.....	70-71, 75
Sterile Wrap Racks.....	90
Suture Carts.....	90
Tables.....	57-58, 79
Theatrical Company Carts.....	42
Trash Receptacles.....	70-77
Utility Carts.....	37-38, 40, 42, 48-49, 53
Vinyl Mattress Covers.....	8
Vinyl Utility Carts.....	38, 42
Water Soluble Laundry Bags.....	7
Wet Floor Signs.....	82
Wringers.....	68

Dear Friend:

Since 1972, Latest Products Corp. has been successfully serving hospitals, nursing homes, correctional institutions and government agencies. Over the years, we continue to add new product offerings and have grown to service thousands of businesses and facilities worldwide in all types of industries. As we celebrate our 40th year in business, we hope you will join our many satisfied customers who rely on us for all their laundry, housekeeping and specialty item needs.

Sincerely,

The Staff at Latest Products Corp.

### Just Some Of Our Latest Products...

Protect Yourself From  
The Bedbug Epidemic



See our Mattress  
& Pillow Protectors  
on page 8.



Go Green with our new Recycling  
Receptacles on pages 69, 78 & 91.

Don't forget to continuously visit our website to see our newly introduced items!!! [www.LatestProducts.net](http://www.LatestProducts.net)

Please make sure we have your email address so we can alert you of new product offerings and our monthly specials!!!



Our Very Popular Custom Embroidered  
Heat-Sealable Emblem Patches

ENGINEERING  
DEPARTMENT



Emblems  
can be  
manufactured  
in up to  
7 colors.

- Use on uniform sleeves or pockets to identify institution, department or name.
- Available in sizes 2" to 16"
- Standard Plastic back for sewing or heat sealable adhesive backing
- Colorfast threads
- Borders can be merrowed (spun thread) or stitched and laser cut



See Page 22 for more information





**For Use Where  
Fluid Protection  
is Required.**

# 100% Impervious Vinyl Leakproof Laundry/Hamper Bags



- Impervious Vinyl
- Leakproof
- Electronically sealed side seams to prevent leakage
- Seamless bottom
- Meets O.S.H.A. requirements
- Complies with O.S.H.A. & NFPA 701 specs, leakproof-flame retardant
- Made of washable vinyl fabric with 100% polyester knit facing
- Resists mildew
- Safely transports heavy, wet soiled linen
- Can be washed 100's of times in temperatures up to 160° F
- Elastic top for firm fit onto hamper or chair back
- 2 webbing tabs set on each side for handling
- Color stripe available

Options available: Bio-Hazard Logo, Name of Institution or Custom Marking.

\*Due to the leakproof construction of these bags, a round bottom option is not available.

IMPERVIOUS FLIP TOP—NO DRAWCORD STRAIGHT BOTTOM*	
#3040 FTRF (#1180)	30" x 40"—18" diameter <b>\$126/Dozen</b>
#4040 FTRF (#1240)	40" x 40"—25" diameter <b>\$137/Dozen</b>
DRAWCORD & B-LOCK WITH STRAIGHT BOTTOM*	
#3040 RFLB (#13040)	30" x 40"—18" diameter <b>\$110/Dozen</b>
#4040 RFLB (#14040)	40" x 40"—25" diameter <b>\$120/Dozen</b>
Colors: White, Blue, Yellow, Green, Pink. MINIMUM ORDER 2 DOZEN	

## Water and Fluid Resistant Polyester Laundry Bags

**Now Available with Round Bottom!**

**A less costly alternative to vinyl bags.  
A low cost water and fluid resistant polyester alternative.**



- Manufactured of 100% polyester
- High density construction
- Seamless bottom
- Resists fluid & bacterial penetration
- Long-term durability
- Laundry compatibility: high temperature and chlorine
- Nylon cord with B-lock closure on drawcord bags
- Elastic top for firm fit onto hamper or chair back
- Attached webbing dump handles at bottom sides of flip top bag are standard. Drawcord models with dump handles—additional charge applies.
- Options available: bio-hazard logo, name of institution or custom marking

*Hamper above sold separately and featured on page 14.*

*Full line of hamperstands featured on pages 12-14 and 16-18.*

POLYESTER FLIP TOP-STRAIGHT BOTTOM	
#3040 FTB (#1180)	30" x 40"—18" diameter <b>\$105/Dozen</b>
#4040 FTB (#1240)	40" x 40"—25" diameter <b>\$119/Dozen</b>
FLIP TOP-ROUND BOTTOM	
#3040 FTBR (#1190)	30" x 40"—18" diameter <b>\$113/Dozen</b>
#4040 FTBR (#1250)	40" x 40"—25" diameter <b>\$124/Dozen</b>
DRAWCORD & B-LOCK WITH STRAIGHT BOTTOM	
#3040 LBB (#13040)	30" x 40"—18" diameter <b>\$82/Dozen</b>
#4040 LBB (#14040)	40" x 40"—25" diameter <b>\$93/Dozen</b>
DRAWCORD & B-LOCK WITH ROUND BOTTOM	
#3040 LBBR (#1219)	30" x 40"—18" diameter <b>\$92/Dozen</b>
#4040 LBBR (#1225)	40" x 40"—25" diameter <b>\$99/Dozen</b>
Colors: White, Yellow, Blue, Pink, Green. MINIMUM ORDER 2 DOZEN	

**Do we have your email address? If not, please contact us at [LPCORP@aol.com](mailto:LPCORP@aol.com) so we can notify you of monthly specials.**



## 18" AND 25" LAUNDRY/HAMPER BAGS

### Standard Ropeless



**Flip Top Bag**  
18" or 25"

- Straight or round bottoms available
- Flip top features:
- Built in pocket handles at bottom
- Turn tabs under hood for easy closing
- Ropeless, flips closed just like a sandwich bag
- All stress points reinforced
- Elastic in hem

### Standard Drawcord



**Drawcord Bag**  
18" or 25"

- Drawcord features:
- Bags have drawcord and Sliplock closure
- Straight or round bottoms available

### COTTON DUCK

100% natural cotton, strong and durable. Not pre-shrunk. Not recommended for wet linen. Will not rot or mildew if left wet. Color available: Natural. Color coded striping also available.

### COTTON/POLYESTER BLEND

A combined fiber that provides the toughness of polyester and strength of cotton duck. Dries quicker than cotton duck. Not pre-shrunk. Colors available: Natural, Orange, Yellow, Burgundy, Red, Hunter Green, and Navy.

### 200 DENIER NYLON

100% nylon pre-shrunk—lightweight requiring minimal drying time. Colors available: Red, Pink, Navy Blue, Royal Blue, Powder Blue, Hunter Green, Kelly Green, Orange, Yellow, White, Black, Burgundy, and Purple. 400 denier nylon also available.



### SPUN-FILAMENT POLYESTER

The blending together of spun and filament polyester yarns provides a durable, strong and non-slippery material. It is unaffected by chlorine and bleach. Highly resistant to rot, mildew and abrasion. Not pre-shrunk. A heavyweight alternative to nylon; non-absorbing. Color available: White.

### BARRIER 100% POLYESTER FLUID RESISTANT LAUNDRY BAG

High density construction. Water repellent coating. Colors available: White, Yellow, Blue, Pink, Green. See pages 3-5.

### IMPERVIOUS VINYL LAUNDRY BAGS

100% leakproof. Seamless bottom, electronically sealed side seams to prevent leakage. Colors available: White, Blue, Yellow, Green, Pink. See pages 3-5.

Fluid resistant bags are used to comply with OSHA's regulation which states: "Whenever contaminated laundry is wet and presents a reasonable likelihood of strike-through or leakage from the bag or container the laundry shall be placed and transported in bags or containers which prevent soak-through and leakage of fluids to the exterior."

Electronic sealing is a heat sealing process which will prevent liquids from leaking. This process is now done on all impervious vinyl laundry bags.

*No representation is made that laundry bags will provide complete protection from exposure to contaminants or will eliminate the risk of contracting infectious diseases.*

**Don't see the laundry bag your facility currently uses? Send us a sample and we'll work up a money-saving quotation for you!**

### FIVE EASY WAYS TO ORDER:

1. **By Mail:** P.O. Box 190 • Syosset, NY 11791
2. **Toll-Free:** 1-800-288-3547

3. **By Fax:** 1-516-367-4714
4. **By email:** LPCORP@aol.com

5. **Through our website:** www.LatestProducts.net

# LAUNDRY BAG PRICE LIST

**ASK FOR  
SPECIAL  
PRICING  
ON 12 DOZEN  
OR MORE!**

Please be sure to specify model number and material desired.  
Colors are available as well as color coding. Prices on request.

**MINIMUM ORDER – 2 DOZEN**

	COTTON DUCK	POLY COTTON	200D NYLON WHITE	200D NYLON COLOR	SPUN FILAMENT POLYESTER	LEAKPROOF IMPERVIOUS VINYL	FLUID RESISTANT 100% POLYESTER
18" Diameter #1180 (18") 30" x 40" Flat Size Flip Top Straight Bottom	\$70.00 DZ	\$82.00 DZ	\$76.00 DZ	\$83.00 DZ	\$82.00 DZ	\$126.00 DZ	\$105.00 DZ
18" Diameter #1190 (18") 30" x 40" Flat Size Flip Top Round Bottom	74.00 DZ	90.00 DZ	85.00 DZ	89.00 DZ	89.00 DZ	N/A	113.00 DZ
25" Diameter #1240 (25") 40" x 40" Flat Size Flip Top Straight Bottom	81.00 DZ	92.00 DZ	85.00 DZ	93.00 DZ	95.00 DZ	137.00 DZ	119.00 DZ
25" Diameter #1250 (25") 40" x 40" Flat Size Flip Top Round Bottom	86.00 DZ	99.00 DZ	94.00 DZ	102.00 DZ	104.00 DZ	N/A	124.00 DZ
18" Diameter #13040 (18") 30" x 40" Flat Size Drawcord Straight Bottom	52.00 DZ	54.00 DZ	54.00 DZ	58.00 DZ	66.00 DZ	110.00 DZ	82.00 DZ
18" Diameter #1219 (18") 30" x 40" Flat Size Drawcord Round Bottom	61.00 DZ	62.00 DZ	64.00 DZ	67.00 DZ	74.00 DZ	N/A	92.00 DZ
25" Diameter #14040 (25") 40" x 40" Flat Size Drawcord Straight Bottom	72.00 DZ	79.00 DZ	74.00 DZ	86.00 DZ	89.00 DZ	120.00 DZ	93.00 DZ
25" Diameter #1225 (25") 40" x 40" Flat Size Drawcord Round Bottom	81.00 DZ	89.00 DZ	87.00 DZ	99.00 DZ	100.00 DZ	N/A	99.00 DZ

**For Polycotton, 200D Nylon, Impervious Vinyl, Fluid Resistant Polyester,  
please specify color if ordering other than white.**

**PLEASE NOTE:** Drawcord bags can be supplied with the cord laced through grommets. The additional cost is \$24.00 per dozen bags. Please specify the proper bag number and add "GR".

**Options Available:** Inside or outside loops; stencilling; bio-hazard label; contamination flap; custom silk screening, and color coding stripes.

**Call for free testing samples.**

We can custom manufacture **any size or style** laundry bag.  
Please contact us to discuss your specific requirements.

**All laundry and net bags are subject to a 25% restocking fee  
for returned items for any reason except manufacturer's defects.**



SINCE 1972, DISTRIBUTORS OF SPECIALTY ITEMS FOR HOSPITALS, NURSING HOMES, INSTITUTIONS

# LATEST PRODUCTS CORP.

P.O. Box 190 • Syosset, New York 11791 • 1-800-288-3547 • Fax 1-516-367-4714 • email LPCORP@aol.com

## LAUNDRY MESH NET BAGS

Collect the laundry in the bag! Wash and dry it in the bag!

Return it in the Bag!

Choice of Three-Hole Rubber Closure Strap or Drawcord in Hem with Sliplock Closure. Standard color is white. Other colors available: red, blue, green, yellow, purple, orange, black, gray, pink, brown, teal. For colors, add 10%. Two color bags can be made from any of these colors. Bags available with identification flags add \$4.50/dozen.

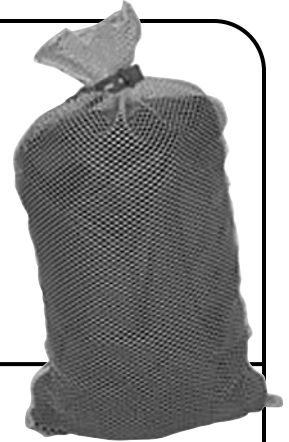

### 100% POLYESTER NET BAGS—STANDARD STRENGTH

STANDARD STRENGTH					
SIZE	DRAWCORD	3 DZ.	6 DZ.	9 DZ.	12 DZ.
14" x 20"	# DC 1420	\$35 DZ.	\$33 DZ.	\$31 DZ.	\$28 DZ.
18" x 24"	DC 1824	37 DZ.	35 DZ.	33 DZ.	30 DZ.
18" x 30"	DC 1830	39 DZ.	37 DZ.	35 DZ.	32 DZ.
24" x 30"	DC 2430	49 DZ.	46 DZ.	42 DZ.	39 DZ.
24" x 36"	DC 2436	51 DZ.	48 DZ.	45 DZ.	41 DZ.
30" x 40"	DC 3040	62 DZ.	59 DZ.	55 DZ.	52 DZ.

STANDARD STRENGTH					
SIZE	RUBBER CLOSURE	3 DZ.	6 DZ.	9 DZ.	12 DZ.
14" x 20"	# RC 1420	\$45 DZ.	\$42 DZ.	\$40 DZ.	\$37 DZ.
18" x 24"	RC 1824	47 DZ.	45 DZ.	42 DZ.	39 DZ.
18" x 30"	RC 1830	49 DZ.	47 DZ.	45 DZ.	41 DZ.
24" x 30"	RC 2430	59 DZ.	56 DZ.	53 DZ.	50 DZ.
24" x 36"	RC 2436	62 DZ.	58 DZ.	55 DZ.	52 DZ.
30" x 40"	RC 3040	75 DZ.	71 DZ.	67 DZ.	63 DZ.

### 100% POLYESTER NET BAGS—INDUSTRIAL STRENGTH

INDUSTRIAL STRENGTH					
SIZE	DRAWCORD	3 DZ.	6 DZ.	9 DZ.	12 DZ.
14" x 20"	# ID 1420	\$49 DZ.	\$46 DZ.	\$42 DZ.	\$38 DZ.
18" x 24"	ID 1824	51 DZ.	48 DZ.	45 DZ.	41 DZ.
18" x 30"	ID 1830	56 DZ.	53 DZ.	50 DZ.	47 DZ.
24" x 30"	ID 2430	66 DZ.	63 DZ.	59 DZ.	55 DZ.
24" x 36"	ID 2436	72 DZ.	68 DZ.	64 DZ.	59 DZ.
30" x 40"	ID 3040	94 DZ.	89 DZ.	84 DZ.	78 DZ.

INDUSTRIAL STRENGTH					
SIZE	RUBBER CLOSURE	3 DZ.	6 DZ.	9 DZ.	12 DZ.
14" x 20"	# IR 1420	\$ 61 DZ.	\$57 DZ.	\$53 DZ.	\$49 DZ.
18" x 24"	IR 1824	64 DZ.	61 DZ.	57 DZ.	53 DZ.
18" x 30"	IR 1830	68 DZ.	65 DZ.	62 DZ.	57 DZ.
24" x 30"	IR 2430	84 DZ.	78 DZ.	73 DZ.	68 DZ.
24" x 36"	IR 2436	86 DZ.	81 DZ.	75 DZ.	70 DZ.
30" x 40"	IR 3040	104 DZ.	99 DZ.	93 DZ.	88 DZ.



STANDARD MESH  
2.3 ounces per square yard.

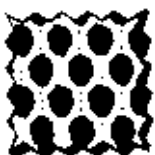

INDUSTRIAL MESH  
3.50 ounces per square yard.

Industrial strength net bags used in commercial laundries can withstand high heat washers/dryers and industrial solvents. For standard strength polyester net bags, do not exceed recommended washing and drying instructions.

Colors: add 10%; sewn on identification flag: add \$4.50/dz.

**Minimum order is three dozen of each size or color.**  
**Quantity discounts available for orders over 12 dozen.**  
**Also available with zipper closure – please inquire.**  
**Also available with open top (no closure) – please inquire.**

Separate personal laundry ☆ safe ☆ sanitary ☆ cost effective  
 Call for free net bag samples

# WATER SOLUBLE LAUNDRY BAGS

## IDEAL FOR COLLECTING AND WASHING BED BUG INFESTED LINEN



- ★ SAFELY COLLECT CONTAMINATED LINEN
- ★ LATEX FREE
- ★ AVOID EXPOSURE TO GERMS, BLOOD OR INFECTED ITEMS
- ★ DISINTEGRATES IN HOT OR COLD WATER WASH

### Standard Duty Hot Water Soluble Clear — Dissolves at 140° F

Product Number	Size	Description	Units/Case	Cost per Case
O-500*	26" x 33"	Isolation Standard Duty	100	\$ 58
O-502*	28" x 39"	Isolation Standard Duty; Fits 18" Hamper	100	73
O-504*	36" x 39"	Isolation Standard Duty; Fits 25" Hamper	100	91

\*Red available at same price as clear.

### Heavy Duty Hot Water Soluble Clear — Dissolves at 140° F

Product Number	Size	Description	Units/Case	Cost per Case
O-508	26" x 33"	Isolation Heavy Duty	100	\$ 79
O-510	28" x 39"	Isolation Heavy Duty; Fits 18" Hamper	100	101
O-512	36" x 39"	Isolation Heavy Duty; Fits 25" Hamper	100	129

### Heavy Duty Cold Water Soluble Clear

Product Number	Size	Description	Units/Case	Cost per Case
O-514	26" x 33"	Isolation Heavy Duty	100	\$ 79
O-516	28" x 39"	Isolation Heavy Duty; Fits 18" Hamper	100	101
O-518	36" x 39"	Isolation Heavy Duty; Fits 25" Hamper	100	129

### Bio-Hazard in Black Print Hot Water Soluble — Dissolves at 140° F

Product Number	Size	Description	Units/Case	Cost per Case
IH015	28" x 39"	RED Isolation Heavy Duty; Fits 18" Hamper	100	\$101
IH016	36" x 39"	RED Isolation Heavy Duty; Fits 25" Hamper	100	129
IH019	36" x 39"	CLEAR Isolation Standard Duty; Fits 25" Hamper	100	91

## Laundry Bag Accessories (sold individually)

Minimum order for accessories is 2 dozen per item with \$25 minimum.

**Bio-Hazard Labels**  
\$2.00 each

**5" Nickel Plated Pins**  
\$2.25 each

**B-Lock**  
65¢ each

**Rubber Closure**  
\$1.75 each

**Drawcord**  
60¢ each

**Ball Lock**  
55¢ each

**Handle Strap**  
95¢ each

**Corner I.D. Flag or 4" x 6" I.D. Flag**  
\$4.50 dozen

**Corner I.D. Flag**

**Mesh or Vinyl 5/8" Pocket**  
\$2.25 each

**Grommets**  
90¢ each

**CUSTOM COLOR STRIPE**  
\$3.50 each

Above prices refer to accessories for customizing your laundry bags.

**TERMS: 2% ten days, net 30, F.O.B. Factory. We prepay shipping and add to invoice.**



SINCE 1972, DISTRIBUTORS OF SPECIALTY ITEMS FOR HOSPITALS, NURSING HOMES, INSTITUTIONS

# LATEST PRODUCTS CORP.

P.O. Box 190 • Syosset, New York 11791 • 1-800-288-3547 • Fax 1-516-367-4714 • email LPCORP@aol.com

## BED BUG PROTECTION WITH MATTRESS AND PILLOW PROTECTORS

BED BUGS . . . every day you read about them in the newspaper or watch a story about them on the nightly news . . . it's a growing epidemic across the country . . . Latest Products is very pleased to announce our complete line of BED BUG PROTECTION six gauge vinyl and stretch polyester knit barrier mattress, box spring and pillow protectors. Our products are already in use by many prominent national hospitals, nursing homes, correctional facilities, hotels/motels, and colleges.

**Some of the features and benefits of our products are:**

- Heavy weight vinyl material, wipes clean with damp cloth
- Water-proof
- Brushed silk finish
- Treated with Ultra-Fresh®, an anti-microbial which inhibits the growth of mold, mildew, fungi and odor causing bacteria
- Fire retardant
- Will not crack to -15°F
- Zippered covers (recommended for maximum protection) have rust-proof polyester zippers
- Electronically sealed seams
- Made in USA
- Special sizes available upon request including 16" deep products
- Sold in case packs only
- All orders ship in 24-48 hours



**Buy 4 or more cases, take 5% off prices shown!**

**SOME OF OUR MOST POPULAR MODELS:**

**6 GAUGE VINYL ZIPPERED MATTRESS/BOXSPRING COVERS—7" Deep**

Item No.	Description
2006	Twin Zippered—39 x 75 x 7—\$54 per case of 6
3006	Full Zippered—54 x 75 x 7—\$63 per case of 6
2006-4	Hospital Twin Zippered—36 x 80 x 7—\$57 per case of 6
2006-2	Long Twin Zippered—39 x 80 x 7—\$59 per case of 6

**6 GAUGE VINYL FITTED MATTRESS/BOXSPRING COVERS—9" Deep**

Item No.	Description
2996	Twin Fitted—39 x 75 x 9—\$30 per case of 6
3996	Full Fitted—54 x 75 x 9—\$36 per case of 6
4996	Queen Fitted—60 x 80 x 9—\$43 per case of 6
5996	Cal King Fitted—72 x 84 x 9—\$50 per case of 6
6996	King Fitted—78 x 80 x 9—\$50 per case of 6
2996-1	Hospital Twin Fitted—36 x 80 x 9—\$33 per case of 6
2996-2	Long Twin Fitted—39 x 80 x 9—\$34 per case of 6
3996-1	Long Full Fitted—54 x 80 x 9—\$39 per case of 6

**6 GAUGE VINYL ZIPPERED MATTRESS/BOXSPRING COVERS—9" Deep**

Item No.	Description
1606	Crib Zippered—28 x 52 x 6—\$46 per case of 6
2096	Twin Zippered—39 x 75 x 9—\$56 per case of 6
3096	Full Zippered—54 x 75 x 9—\$65 per case of 6
4096	Queen Zippered—60 x 80 x 9—\$81 per case of 6
5096	Cal King Zippered—72 x 84 x 9—\$95 per case of 6
6096	King Zippered—78 x 80 x 9—\$95 per case of 6
2096-4	Hospital Twin Zippered—36 x 80 x 9—\$59 per case of 6
2096-3	Hospital XL Twin Zippered—36 x 84 x 9—\$60 per case of 6
3096-2	Long Twin Zippered—39 x 80 x 9—\$62 per case of 6
3096-1	Long Full Zippered—54 x 80 x 9—\$68 per case of 6

**6 GAUGE VINYL ZIPPERED PILLOW COVERS**

Item No.	Description
1006	Standard Zippered—21 x 27—\$24 per case of 12
1007	Queen Zippered—21 x 31—\$27 per case of 12
1009	King Zippered—21 x 37—\$31 per case of 12

**Tested and Certified Bed Bug Protection!**

**STRETCH POLYESTER KNIT BARRIER MATTRESS/BOXSPRING COVERS—9" DEEP**  
**BEST OPTION FOR TRUE BED BUG BARRIER PROTECTION**  
**IDEAL FOR PROTECTION AGAINST DUST ALLERGENS**

Item No.	Description
93680Z	Hospital Twin Zippered—36 x 80 x 9—\$388 per case of 12
93975Z	Regular Twin Zippered—39 x 75 x 9—\$372 per case of 12
93980Z	Long Twin Zippered—39 x 80 x 9—\$388 per case of 12
95475Z	Full Zippered—54 x 75 x 9—\$453 per case of 12
95480Z	Long Full Zippered—54 x 80 x 9—\$486 per case of 12
96080Z	Queen Zippered—60 x 80 x 9—\$535 per case of 12
97880Z	King Zippered—78 x 80 x 9—\$648 per case of 12
97284Z	Cal. King Zippered—72 x 84 x 9—\$648 per case of 12
9220Z	Standard Zippered Pillow Covers—21 x 27—\$52 per case of 24
9221Z	Queen Zippered Pillow Covers—21 x 31—\$59 per case of 24
9222Z	King Zippered Pillow Covers—21 x 37—\$68 per case of 24

**Don't forget to ask us about**  
**12" & 16" DEEP ZIPPERED MATTRESS/BOXSPRING COVERS**  
**AND**  
**QUILTED WATERPROOF MATTRESS PADS**

**Don't let the bed bugs bite!**



# HAMPER CAPS

**Money-Saving Idea!**

**Don't Stop Using Your Old Open Hamperstands!**

**THE MOST INEXPENSIVE WAY TO CONVERT THEM TO COVERED STANDS AND COMPLY WITH JOINT COMMISSION OR O.S.H.A.**



**HAMPER CAP**  
(Lift off to load linen)



**TOP-LOADING CAP**  
(Load linen through top slot)

Made from 200 Denier Nylon with ties to fasten to frame and with elastic for snug fit.

**Fits 18" - 25" Hampers**

Call for free testing sample.

Washable — fits 18" - 25" Hampers

Two styles available—standard color is white—many other colors available, including Green, Red and Blue. For colors add 10%.

**#18000-1 PULL-OFF CAP (NO SLOT)**

2 Doz (Min) to 5 Doz .....\$76.00 Doz  
6 Doz to 11 Doz .....72.00 Doz  
12 Doz and More .....67.00 Doz

**#18015-2 LOADING THROUGH SLOT**

2 Doz (Min) to 5 Doz .....\$82.00 Doz  
6 Doz to 11 Doz .....77.00 Doz  
12 Doz and More .....72.00 Doz

## CHAIR BACK LAUNDRY BAGS

Ideal for long-term patients in nursing homes or assisted living facilities.



Chairback.

15" (38 cm) diameter. Flip-top, straight bottom, no elastic in flip-top. Flat measure: 24" x 36", bags have dump handles.

#1130

	ITEM #	PRICE PER DOZEN
Cotton Duck	1130-1	\$60.00
Poly Cotton Blend	1130-2	58.00
200 Denier Nylon (white, blue, green)	1130-3	61.00
Spun Filament Polyester	1130-4	71.00
Impervious Leakproof Vinyl (blue or white)	1130-5	77.00
Barrier Fluid Resistant (white, blue, green)	1130-6	83.00

## SANITARY NYLON LINERS & COVERS

Designed for transport and storage of clean or soiled linen. Made of heavy duty 200-denier white nylon. Easily laundered.



**No. 107 NYF**

**NO. 107 NYF BASKET LINER** and cover flap with elastic top hem.



**No. 107 NY**

**NO. 107 NY BASKET LINER (only)** Without flap. Elastic in top hem.



**No. 107 NYC**

**NO. 107 NYC NYLON CAP OR COVER (only)** With elastic in top hem keeps basket contents clean. 107NYC available in special sizes.

BUSHEL CAPACITY	NO. 107 NY NYLON LINER	NO. 107 NYF NYLON LINER WITH TOP FLAP	NO. 107 NYC TOP COVERS OR CAPS ONLY
4	\$23.75	\$28.25	\$15.50
5	23.75	28.25	15.50
6	23.75	28.25	15.50
8	25.95	30.75	16.50
10	27.50	32.50	17.00
12	29.25	34.55	17.75
14	30.50	36.25	19.75
16	31.75	37.75	19.75
18	33.00	39.25	20.80
20	37.25	44.25	22.25

Also available: 400 Denier Nylon, Reinforced Vinyl, Water Resistant Material, Custom Colors, and Custom Sizes. Call for pricing.

Custom needs? Please inquire. We can manufacture to your specifications. Samples always available.



SINCE 1972, DISTRIBUTORS OF SPECIALTY ITEMS FOR HOSPITALS, NURSING HOMES, INSTITUTIONS

# LATEST PRODUCTS CORP.

P.O. Box 190 • Syosset, New York 11791 • 1-800-288-3547 • Fax 1-516-367-4714 • email LPCORP@aol.com

## CART COVERS

Use on LINEN EXCHANGE CARTS-LAUNDRY TRUCKS to keep linen clean.

Use on CENTRAL SUPPLY-LAB-MEDICINE CARTS to ensure sterility.

Use on BULK DELIVERY-TURNABOUT-FOOD TRANSPORT CARTS  
and any other cart which needs a cover.

Also Ideal for Covering Shelving Units and Medical Equipment.

FULL FLAPS, REINFORCED CORNERS, DOUBLE NEEDLE CONSTRUCTION  
CHOICE OF HEAVY DUTY ZIPPERS OR VELCRO CLOSURE

### Choose from these materials:

**200 Denier Nylon:** 200 Denier nylon is a lightweight fabric used mostly in low impact applications such as storage and non-transporting carts. This fabric is both economical and consistent. Washable.

**420 Denier Nylon:** 420 Denier nylon is our most popular fabric for cart and shelving covers. This medium weight fabric is easy to handle, provides excellent durability, and represents a great value all around. Washable.

**1000 Denier Nylon:** 1000 Denier cordura nylon is used for the highest impact applications such as linen transportation carts. This rugged, heavy weight fabric is similar to that used for luggage and backpacks. Washable.

**13 Ounce Reinforced Vinyl:** 13 ounce vinyl fabric is most commonly used for industrial applications. This flame-retardant, OSHA approved medium weight fabric is easy to handle. Wipes clean.

**#30 Easy-Grab Vinyl:** Our Easy-Grab has revolutionized cart covers. With a slitted, see-through clear vinyl front, there is no need to lift a front flap. Just reach in and grab the cart or shelving unit contents such as linen, medicine or supplies. The replaceable vinyl slats wipe clean. The top, back and sides of the cover are made with your choice of 420 denier nylon, 13 ounce vinyl or #20 Staphcheck.

**#20 Staphcheck:** Staphcheck vinyl fabric is most commonly used in the health care industry. This is an anti-bacterial, flame-retardant, OSHA approved fabric. This medium weight fabric is easy to handle. Wipes clean.

**#10 Gauge Clear See-Through Vinyl:** Cover has a completely see-through front, back and sides. Wipes clean.

FOR STANDARD  
SIZES AND PRICES  
SEE NEXT PAGE



For sizes not listed or to verify size wanted, measure:

- ① Width: front to back    ② Length: Left to right    ③ Height: to top of casters



All prices are F.O.B. factory



**FINEST  
QUALITY  
—  
LOWEST  
PRICES**

# Thousands of Cart Covers Sold Each Year!

**COMPARE  
OUR  
PRICES  
WITH  
OTHERS!**

**Don't see your size? We can manufacture to your specifications.**

Did you know that Latest Products Corporation is one of the nation's largest suppliers of cart covers and shelving covers? All of our covers are custom designed to your specifications. We use reinforced corners on all covers to withstand wear and tear, and utilize either reinforced Velcro or heavy duty zippers to provide a more secure closure.

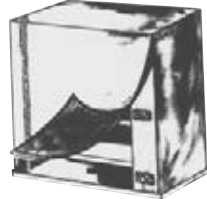

**For Sizes Not Listed,  
Please Ask for Quote.**

How to Measure Cart:  
**Width** - Front to Back  
**Length** - Left to Right  
**Height** - Top of Cart to  
Top of Casters

Material Description	Dimensions W x L x H	Price Each			Material Description	Dimensions W x L x H	Price Each				
		2*	3-5	6+			2*	3-5	6+		
<b>200 Denier Nylon:</b> Durable, Washable, White, Green, Blue, Red, Yellow	18" x 48" x 52"	\$ 62.00	\$ 59.00	\$56.00	<b>#30 Easy-Grab Vinyl with 420 Denier nylon top, back and sides.</b> Please specify Nylon color from list to your left.	18" x 48" x 52"	\$114.00	\$110.00	\$107.00		
	18" x 48" x 62"	65.00	62.00	59.00		18" x 48" x 62"	118.00	113.00	110.00		
	18" x 48" x 72"	72.00	69.00	65.00		18" x 48" x 72"	137.00	133.00	130.00		
	24" x 48" x 52"	65.00	62.00	59.00		24" x 48" x 52"	121.00	118.00	114.00		
	24" x 48" x 62"	69.00	66.00	63.00		24" x 48" x 62"	124.00	121.00	118.00		
	24" x 48" x 72"	76.00	74.00	70.00		24" x 48" x 72"	145.00	142.00	139.00		
	24" x 60" x 52"	69.00	66.00	63.00		24" x 60" x 52"	128.00	125.00	122.00		
24" x 60" x 62"	76.00	73.00	69.00	24" x 60" x 62"	131.00	128.00	125.00				
24" x 60" x 72"	81.00	78.00	74.00	24" x 60" x 72"	156.00	153.00	150.00				
<b>420 Denier Nylon Pack Cloth:</b> Strong, Washable, White, Red, Hunter Green, Yellow, Gray, Royal Blue, Navy, Burgundy, Khaki, Black, Olive	18" x 48" x 52"	74.00	70.00	67.00	<ul style="list-style-type: none"> <li>• If ordering top, back and sides using 13 ounce vinyl, and not 420 Denier nylon, add 15% to above pricing.</li> <li>• If ordering top, back and sides using #20 staphcheck, and not 420 Denier nylon, add 20% to above pricing.</li> <li>• Please remember to specify color for top, back and sides.</li> </ul>	<b>#20 StaphCheck: Wipes Clean</b> White, Green, Powder Blue, Navy Blue, Tan, Mauve	18" x 48" x 52"	88.00	84.00	80.00	
	18" x 48" x 62"	79.00	76.00	73.00			18" x 48" x 62"	93.00	90.00	87.00	
	18" x 48" x 72"	84.00	81.00	78.00			18" x 48" x 72"	102.00	100.00	95.00	
	24" x 48" x 52"	79.00	76.00	73.00			24" x 48" x 52"	95.00	90.00	86.00	
	24" x 48" x 62"	83.00	80.00	77.00			24" x 48" x 62"	99.00	95.00	90.00	
24" x 48" x 72"	91.00	87.00	83.00	24" x 48" x 72"			109.00	105.00	101.00		
24" x 60" x 52"	81.00	78.00	75.00	24" x 60" x 52"			100.00	96.00	91.00		
24" x 60" x 62"	89.00	85.00	81.00	24" x 60" x 62"			107.00	103.00	99.00		
24" x 60" x 72"	99.00	93.00	89.00	24" x 60" x 72"			118.00	113.00	109.00		
<b>1000 Denier Nylon:</b> Extremely Durable, Washable, White, Green, Blue, Gray	18" x 48" x 52"	87.00	83.00	80.00			<b>#10 Gauge Vinyl, Clear: Wipes Clean.</b>	18" x 48" x 52"	77.00	74.00	70.00
	18" x 48" x 62"	92.00	88.00	85.00				18" x 48" x 62"	82.00	79.00	76.00
	18" x 48" x 72"	96.00	91.00	87.00				18" x 48" x 72"	85.00	81.00	77.00
	24" x 48" x 52"	91.00	87.00	83.00				24" x 48" x 52"	80.00	77.00	72.00
	24" x 48" x 62"	97.00	92.00	88.00				24" x 48" x 62"	85.00	82.00	79.00
24" x 48" x 72"	100.00	96.00	92.00	24" x 48" x 72"				93.00	90.00	87.00	
24" x 60" x 52"	103.00	99.00	96.00	24" x 60" x 52"	85.00	82.00		79.00			
24" x 60" x 62"	106.00	102.00	99.00	24" x 60" x 62"	93.00	89.00		85.00			
<b>13 Oz. Vinyl Reinforced:</b> Wipes Clean, White, Green, Black, Blue, Gray, Red, Tan, Yellow	18" x 48" x 52"	84.00	81.00	78.00	24" x 60" x 72"	103.00		99.00	96.00		
	18" x 48" x 62"	89.00	85.00	81.00	<b>CUSTOMIZED EXTRAS</b>						
	18" x 48" x 72"	97.00	92.00	88.00	Hand Holes	..... \$8.00 each					
	24" x 48" x 52"	89.00	85.00	81.00	Top Flap	..... Add 25% to cost					
	24" x 48" x 62"	96.00	91.00	87.00	Extra Zippers	..... \$10.00 each					
24" x 48" x 72"	106.00	102.00	98.00	Clear Vinyl Front Flap	..... Add 25% to cost						
24" x 60" x 52"	96.00	91.00	87.00	9" x 12" Clear Vinyl Pocket	..... \$8.00 each						
24" x 60" x 62"	102.00	98.00	93.00	Tie Tapes	..... \$2.50 each						
24" x 60" x 72"	111.00	107.00	103.00	Side Flaps	..... Add 25% to cost						
				Linen Pocket	..... Add 25% to cost						
				Clear Vinyl Window	..... \$12.00 each						
				Color Coded Stripes	..... \$10.00 each						
				Urethane Coated 200D & 420D	..... Add 20% to cost						
				Stenciling (Min. 12 Covers)	..... \$10.00 each plus cost of stencil						

**DISPOSABLE CART COVERS NOW AVAILABLE.**  
See our website—cart cover section  
[www.LatestProducts.net](http://www.LatestProducts.net) for details.

**NOTE:** Proper care should be taken to ensure that you provide us with the correct measurements, style, material, color, and details. NO RETURNS ARE ALLOWED, unless it is determined to be a manufacturer's defect.

\* If ONLY ONE CART COVER IS ORDERED, PLEASE ADD \$15.00 HANDLING CHARGE TO PRICE SHOWN.

**FIVE EASY WAYS TO ORDER:**

- 1. By Mail: P.O. Box 190 • Syosset, NY 11791
- 2. Toll-Free: 1-800-288-3547
- 3. By Fax: 1-516-367-4714
- 4. By email: LPCORP@aol.com
- 5. Through our website: [www.LatestProducts.net](http://www.LatestProducts.net)



SINCE 1972, DISTRIBUTORS OF SPECIALTY ITEMS FOR HOSPITALS, NURSING HOMES, INSTITUTIONS

# LATEST PRODUCTS CORP.

P.O. Box 190 • Syosset, New York 11791 • 1-800-288-3547 • Fax 1-516-367-4714 • email LPCORP@aol.com

## HAMPERSTANDS—CHROME AND STAINLESS



**2010 SQUARE WITH LID & FOOT PEDAL AND BAG LOCKING RING**  
 18½" W x 19½" deep x 38" H  
 Requires easy assembly.  
 3" locking casters.  
**Open design for easy unloading and minimal lifting.**



**ROUND 33330-2018**  
 18" Dia. x 35" H  
 Holds 18" bags.  
**2" casters.**

**ROUND 33340-2025**  
 25" Dia. x 36" H  
 Holds 25" bags.  
**3" casters.**  
**Durable chrome plated steel.**



**TILT-TOP ROUND 33334-2118** 20" Dia. x 36" H  
 Holds 18" bags.  
**Foot Pedal Operated Lid with 2" casters.**  
**RECOMMENDED FOR INFECTION CONTROL.**  
 Durable chrome plated steel lid & frame. Spring loaded lid.  
**Also available with top red lid.**



**34000 BAG HOLDER KIT**



**FOLDING ADJUSTABLE 33395-5061**  
 Holds 18-22" or 25" bags.  
 3" casters.  
 This model also available with lid, see below—model #33395-5061/6061 or with foot pedals—see model #5055, page 14.

These Hamperstands are for use with 18" and 25" Fabric Laundry Bags. (On #33340, please make sure you use 25" Dia. bags – flat measure 40" x 40".) For use with polybags we recommend our Plastic Bag Holder #34000.



**TRIANGULAR SPACE-SAVER HAMPER, 18" D**

**Model 2301SS Triangular Space-Saver Hamper** offers hands-free loading and unloading with a convenient non-slip pedal. All stainless steel construction. Bumper guards on stainless steel lid and legs protect equipment and walls. Solid shelf on bottom provides extra security with heavy loads. This hamper travels effortlessly on three, 3" hard rubber swivel casters. 18" D x 32" H.  
**For non-stainless steel—see pricing below—model #2302NONSS.**

Number	Description	1	2	3-5	6 or more
2010	Square - Foot Pedal-Lid	\$155.00	\$150.00	\$145.00	\$135.00
33330-2018	18" Round	120.00	115.00	110.00	105.00
33340-2025	25" Round	135.00	130.00	125.00	120.00
33395-5061	Folding Adjustable 18-22-25" Bags	95.00	90.00	85.00	80.00
33395-5061/6061	Folding Adjustable 18-22-25" Bags with Lid	125.00	120.00	115.00	105.00
33334-2118	Tilt Top 18" Foot Pedal Opens Lid (chrome lid standard)	200.00	195.00	190.00	180.00
34000	Bag Holder Kit for 18" Round	63.00	58.00	53.00	48.00
2301SS	Triangular Space-Saver Hamper 18" Stainless	395.00	385.00	375.00	365.00
2302NONSS	Triangular Space-Saver Hamper 18" Non Stainless	195.00	190.00	185.00	180.00

**TERMS: 2% ten days, net 30, F.O.B. Factory. We prepay shipping and add to invoice.**



# POLYETHYLENE HAMPERSTAND WITH LID

Reduce risk of infection when removing linen.  
Totally enclosed when lid and revolving door are closed.



Hamper-Host shown open.



Hamper-Host shown closed.

The Hamper-Host stand is available in two sizes that fit either 18" or 25" laundry bags and your choice of 17 colors. The Hamper-Host stand is top-loading, with an integral lid so that bag and contents are completely enclosed for maximum protection and to meet Joint Commission infection control guidelines. The spring controlled lid closes gently to avoid airborne contamination. A front door allows no-lift removal of the full bag. Once the bag is filled, the outer shell is rotated to open the door. The Hamper-Host stand can be easily cleaned and sanitized with hot water. Units are shipped fully assembled. Two 3" wheels facilitate pushing or pulling. Lid opens and closes easily by hand or by using a foot pedal (priced below). The Hamper-Host is manufactured of 100% polyethylene.

**17 colors available:** Red, Brite Yellow, Brilliant Orange, Jade Green, Honey Gold, Powder Blue, Metallic Silver, Pink, Wine, Cadet Blue, Royal Blue, Purple, Beige, Brown, Black, Lime Green, Forest Green

Hamper-Host Model Number	Dimensions	Laundry Bag Size	Max. Capacity	1	2-3	4-5	6 or more
03H18	18" Diameter x 30 1/2" deep x 34" overall height	18"	26 1/4 gallons	\$245	\$235	\$230	\$225
04H25	22 1/2" Diameter x 30 1/2" deep x 34" overall height	25"	45 gallons	255	245	240	235

Since Hamper-Hosts are molded to your specific color selection and are not returnable, it is very important that you determine which size you need. #03H18 holds an 18" diameter linen bag (30" x 40" flat measure) or holds a 44 gallon polybag. #04H25 holds a 25" diameter linen bag (40" x 40" flat measure) or a 55 gallon polybag.

# POLYETHYLENE HAMPERSTAND WITH FOOT PEDAL

- Foot pedal as an added convenience.
- No need to touch lid for opening.
- Sizes, colors and features as shown above.

F03H18 (for 18" bag)				F04H25 (for 25" bag)			
1	2-3	4-5	6 or more	1	2-3	4-5	6 or more
\$310	\$300	\$290	\$285	\$320	\$310	\$300	\$295



# STAINLESS STEEL MRI-ROOM HAMPERSTANDS

MRI-Room hamperstands are designed to be safely used near MRI equipment. These hamperstands have a round tubular ring that is seamlessly welded to three legs. A solid, round platform on the bottom acts as a bracing and protects the hamper bag from contact with the floor. A reinforced, dome-shaped lid of high-density, white polyethylene (model 7772MR-PL) is recommended to control airborne pathogens. All hamperstands move easily over floors on 2" MRI-safe swivel casters. Uses 18" laundry bags.

Model Number	Shipping Weight (lbs.)	Lid	Dimensions (overall)	1	2-3	4-5	6 or more
7772MR	20	None	20" Diameter x 35" Height	\$465	\$445	\$425	\$415
7772MR-PL	40	Plastic	22" Diameter x 36 1/2" Height	680	660	640	620

For our full line of laundry bags see pages 3, 4, 5.

We carry a complete line of MRI-Room products, please contact us for details.



SINCE 1972, DISTRIBUTORS OF SPECIALTY ITEMS FOR HOSPITALS, NURSING HOMES, INSTITUTIONS

# LATEST PRODUCTS CORP.

P.O. Box 190 • Syosset, New York 11791 • 1-800-288-3547 • Fax 1-516-367-4714 • email LPCORP@aol.com

## FOLDING ADJUSTABLE HAMPERSTANDS WITH LIDS

**OUTSTANDING VALUE!**



**COMPLY WITH OSHA AND OTHER REGULATIONS  
IDEAL FOR USE WITH CLOTH AND PLASTIC BAGS  
MUST BE ORDERED AS A SET**

Adjusts to fit any bag size from 18" to 25". Stand is chrome plated 1" tubular steel. Cover is aquamarine color and has convenient hand grip for easy opening and closing. Stand and cover shipped in two cartons. Cover easily assembled. Folds to 6" for easy storage.

#5061 Hamperstand } please order  
#6061 Cover } by these numbers

1	2	3-5	6-11	12 or more
\$125.00	\$120.00	\$115.00	\$110.00	\$105.00

**ALSO AVAILABLE WITH SPRING LOADED FOOT PEDAL FOR EASY "HANDS FREE" LID OPENING!**

**FULLY ASSEMBLED • MODEL #5055**

1	2	3-5	6-11	12 or more
\$155.00	\$150.00	\$145.00	\$140.00	\$135.00

Easy roll 3" non-marking, silent casters. 36½" H, 17¼" W, 17½" D, 21 lbs.

## DELUXE TUBULAR STEEL HAMPERS

**COMES WITH STANDARD WHITE LID**



**684** Double Leakproof Hamper with Foot Pedal 37½" L x 17¾" W x 37½" H. Includes 2 bags

### TO EASE WORKLOAD

- Leakproof system includes removable and washable vinyl bags
- Heavy 7/8" steel tubing with chrome finish
- Lids are high impact, hands-free design
- Foot pedal for easy opening
- 4" casters (2 swivel/2 locking brake)
- Replacement bags available

**Specify bag colors: Available in White, Green, Pink, Blue.**

Bags are ultrasonically welded with reinforced seams for long life. Additional bags available.

Additional replacement bag #680 – 30" x 35" flat size.

\$35.00 per bag. Specify color when ordering.

Double hamper includes two bags. Triple hamper includes three bags.

**FLAME RETARDANT BAGS**



**686** Triple Leakproof Hamper with Foot Pedal 55½" L x 17¾" W x 37½" H. Includes 3 bags

		1-2	3-5	6 or more
Model <b>684</b>	Double Hamper with two bags	\$270.00	\$265.00	\$260.00
Model <b>686</b>	Triple Hamper with three bags	\$385.00	\$380.00	\$375.00

Please specify bag color when ordering.

**Hampers if returned are subject to a 25% restocking fee plus freight charges.  
Please verify colors, sizes and options carefully when ordering.**



# POLYETHYLENE MOBILE CART



## Ideal for Contaminated Linen

A rugged, virtually unbreakable mobile cart that's just the right size for easy handling in dozens of uses.

- Dozens of uses including industrial, commercial, restaurants, hotels, hospitals, retirement homes.
- Constructed of polyethylene, molded container with attached poly cover.
- Easy to remove from rustproof, galvanized steel dolly for cleaning.

*We can put 2 or 3 or 4 units on a common base.*

### Big Tiger

Complete with four 2" diameter casters. **Inside dimensions:** Length 18" x 16 1/2" wide x 32" deep. **Outside dimensions:** Length 22" x 19 1/2" wide x 36" high overall including dolly. **Approximate weight:** 22 1/2 lbs. Holds approximately 4 3/4 bushels or 300 lbs of liquid or 36 gallons.

### Lil' Tiger

Complete with four 2" diameter casters. **Inside dimensions:** Length 18" x 10" wide x 32" deep. **Outside dimensions:** Length 22" x 13 1/4" wide x 36" high overall including dolly. **Approximate weight:** 17 lbs. Holds approximately 2 2/3 bushels or 150 lbs of liquid or 18 gallons.

#### Big Tiger

# 638 DBC with attached polyethylene cover  
# 638 DB without cover

	1	2-3	4 or more
# 638 DBC with attached polyethylene cover	\$225.00	\$215.00	\$210.00
# 638 DB without cover	170.00	160.00	155.00

#### Lil' Tiger

# 633 DBC with attached polyethylene cover  
# 633 DB without cover

# 633 DBC with attached polyethylene cover	\$190.00	\$180.00	\$175.00
# 633 DB without cover	140.00	130.00	125.00

*For 3" diameter casters (add 1" to height)—add \$7.00 per cart.*

**FREE  
STENCILING  
AVAILABLE**

## POLYETHYLENE MULTI-PURPOSE CART WITH HINGED LID

### Use for Infectious Waste or Linen

100% Galvanized Rust-Proof Steel Base and 3 1/2" Casters

*See below for colors.*

#### CASTER ARRANGEMENTS:

- A – Swivel on four corners
- B -- Two rigid and two swivel on each end.

**Colors:** Black, White, Red, Powder Blue, Royal Blue, Burgundy, Orange, Beige, Forest Green, Yellow, Metallic Silver (Gray).

Lid available in White only.



# 139-12 (.190 wall thickness)	12 bushel 36"L x 24"W x 28"D	\$355.00
# 139-14 (.190 wall thickness)	14 bushel 39"L x 27"W x 28"D	375.00
# 139-16 (.190 wall thickness)	16 bushel 39"L x 27"W x 31"D	390.00

## PUSH N' PULL HANDLE



**Model # PP03** \$149.00

- A great back saver
- Eliminates bending
- Less effort to push
- Easy to install
- Easy to clean
- Fits most poly trucks and vinyl or canvas trucks. Please specify when ordering.

**TERMS: 2% ten days, net 30, F.O.B. Factory. We prepay shipping and add to invoice.**



SINCE 1972, DISTRIBUTORS OF SPECIALTY ITEMS FOR HOSPITALS, NURSING HOMES, INSTITUTIONS

# LATEST PRODUCTS CORP.

P.O. Box 190 • Syosset, New York 11791 • 1-800-288-3547 • Fax 1-516-367-4714 • email LPCORP@aol.com

## DELUXE HEAVY DUTY TUBULAR STEEL HAMPERS

Recommended to be Used With Disposable  
33-40 Gallon Polybags.



Now with convenient bag locking device to hold polybags in place

Outer replacement bag #670 available

#672 shown with bag opening at front with velcro attachment.

### 672 "EASY ACCESS" HAMPER W/FOOT PEDAL

"Easy Access" Bags are constructed of Sure-Chek™, one of the best antibacterial fabrics approved for institutional use. Fabric has antibacterial and flame retardant properties built in. All deluxe hampers are constructed from 7/8" tubular steel with a sturdy chrome finish. All units ship knocked-down.

All hampers come with 4" casters and 2 swivel/2 locking brake casters.

Laundry bag, which comes with hamper, holds linen, laundry or disposable polybag and opens from front with velcro attachment.

Additional or replacement bag available: #670 \$55 each

18" L x 13 1/2" W x 25" D



674 "Easy Access" Hamper w/ Foot Pedal —Double Hamper

Standard white lid



676 "Easy Access" Hamper w/ Foot Pedal —Triple Hamper

### COLOR HAMPER LIDS

#### COORDINATE WINGS OR HAMPER CONTENTS

#### COLORS AVAILABLE

- 602 White (Standard)
- 602B Blue
- 602BR Brown
- 602N Black
- 602R Red
- 602Y Yellow



Lid size (18 1/2" L x 17 3/4" W x 2 1/2" D)

Color lids are available with an upcharge of \$5 per lid.

Item	1	2-5	6+
Single 672	\$185	\$180	\$175
Double 674	300	295	290
Triple 676	435	430	425

Bulk polybag holder available which clips onto the side of the hamper. Model #661: \$20 each.

Bags available in White, Green, Pink, or Blue. Please specify when ordering.

See opposite page for Hamper Labels

Hampers if returned are subject to a 25% restocking fee plus freight charges. Please verify colors, sizes and options carefully when ordering.

# DELUXE HAMPERS WITH “LEAKPROOF” BAGS



**SINGLE** (18½" L x 17¾" W x 37½" H)  
**682** Single “Leakproof” Hamper  
w/ Foot Pedal

**DOUBLE** (37½" L x 17¾" W x 37½" H)  
**684** Double “Leakproof” Hamper  
w/ Foot Pedal

**TRIPLE** (55½" L x 17¾" W x 37½" H)  
**686** Triple “Leakproof” Hamper  
w/ Foot Pedal



**684** “Leakproof” Hamper w/ Foot Pedal



**686** “Leakproof” Hamper w/ Foot Pedal

## 682 “LEAKPROOF” HAMPER W/FOOT PEDAL

“Leakproof” Bags are constructed of **flame retardant** vinyl specially formulated to be launderable. Ultrasonically welded and reinforced seams assure leakproof performance and durable long life. Bags have shock corded rim and envelope closure. All deluxe hampers are constructed from 7/8" tubular steel with a sturdy chrome finish and 4" casters (2 swivel/2 locking brake casters). All units ship knocked-down.

Additional replacement bag available: #680      \$40 each  
30" x 35" flat size.

Item	1	2-5	6+
682	\$165	\$160	\$155
684	270	265	260
686	385	380	375

Bags available in White, Green, Pink, or Blue.  
Please specify when ordering.

## BILINGUAL HAMPER LABELS (ENGLISH & SPANISH)

<b>HAMPER LABEL, SOILED LINEN</b>		
<b>602SLB</b>	Blue Lettering, Pack of 5	\$38
<b>602SLW</b>	White Lettering, Pack of 5	\$38
<b>HAMPER LABEL, INFECTIOUS LINEN</b>		
<b>602IL</b>	Red Lettering, Pack of 5	\$38
<b>HAMPER LABEL, BIOHAZARD WASTE</b>		
<b>602BW</b>	Black Lettering, Pack of 5	\$38
<b>RECEPTACLE LABEL, TRASH/WASTE</b>		
<b>602TWG</b>	Gray Lettering, Pack of 5	\$38
<b>602TWT</b>	Tan Lettering, Pack of 5	\$38
<b>HAMPER LABEL, RESIDENT PERSONAL LINEN</b>		
<b>602RL</b>	Green Lettering, Pack of 5	\$38

Label size (12" x 4")

See opposite page for Color Hamper Lids

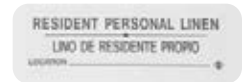
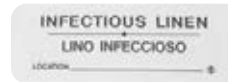

Many other Hampers and Hamperstands available.  
Please see preceding pages.





SINCE 1972, DISTRIBUTORS OF SPECIALTY ITEMS FOR HOSPITALS, NURSING HOMES, INSTITUTIONS

# LATEST PRODUCTS CORP.

P.O. Box 190 • Syosset, New York 11791 • 1-800-288-3547 • Fax 1-516-367-4714 • email LPCORP@aol.com

## PVC SOILED LINEN HAMPERS

We will customize our PVC hampers to fit your needs. A little higher, lower, wider, narrower – it doesn't matter! Contact us for details!



**C-LH-21**                    **\$210**  
37" H x 18" L x 18" W  
Price includes foot pedal.



**C-JH-41**                    **\$240**  
37" H x 22" L x 21" W  
Foot pedal not included in price.  
Add \$45 for foot pedal.



**C-JH-42**                    **\$440**  
37" H x 45" L x 21" W  
Foot pedal not included in price.  
Add \$65 for foot pedal.



**C-LH-22**                    **\$345**  
37" H x 37" L x 18" W  
Price includes foot pedal.



**C-LH-23**                    **\$495**  
37" H x 58" L x 18" W  
Price includes foot pedal.

### All Units Feature

- 3" Casters standard
- Available in Standard (LH) and Jumbo (JH) sizes
- Easy release and removal of plastic liners or bags
- Eliminates excessive bending and lifting
- Foot pedals are available on all LH and JH models
- Coated wire hangers securely hold liners or bags
- LH and JH models use standard 39 gallon plastic liners
- Includes either mesh zipper-front bag (colors: Navy, Blue, Plum, Wineberry, Maroon, Laguna, Forest Green, or White) or washable leak-proof bag (colors: Mint, Light Blue, Pink, or White).

### Fully-Customizable Units Available!



- Uses disposable and reusable bags
- Can be customized to your bag, space or service conditions
- Available with or without lid
- Custom labels/stickers help identify your dirty linen hampers, department or station
- Available in MRI-compatible version
- Can be upgraded with deluxe casters

See our website for a laundry bag color chart.

PVC is the most commonly used polymer for plastic hospital products.

# ECONOMY STANDS—METAL FRAMES ONLY



#23NCS or #23NCL

**Small** 18" L x 12" W x 32" H  
#23NCS

**Large** 18" L x 18" W x 32" H  
# 23NCL

	Plain 11/32" Steel	Plated 11/32" Steel
Small #23NCS	\$26.00	\$29.00
Large #23NCL	\$27.00	\$31.00

## BAG HOLDERS/CADDIES



#230 or #235



#232 or #237

Small Size Stay-Open  
Bag & Net Caddy  
18" Long x 12" Wide x 35" High

Large Size Stay-Open  
Bag & Net Caddy  
18" Long x 18" Wide x 35" High

Bag Holders	Model	Small Size Stay-Open Bag & Net Caddy		Large Size Stay-Open Bag & Net Caddy		
		Plain 11/32" Steel	Plated 11/32" Steel	Plain 11/32" Steel	Plated 11/32" Steel	
Frame only On Hardwood Runners	#230	\$30.00	\$32.00	#235	\$31.00	\$34.00
Frame w/10 oz canvas bag On Hardwood Runners	#231	\$54.00	\$57.00	#236	\$58.00	\$62.00
Frame only On 2" swivel casters*	#232	\$39.00	\$42.00	#237	\$41.00	\$44.00
Frame w/10 oz canvas bag On 2" swivel casters*	#233	\$64.00	\$68.00	#238	\$68.00	\$72.00

\*Available with 3" diameter rubber swivel casters at extra price of \$10.00 per cart. Add 1" to overall height.  
Above prices are per unit. For orders of 5 or more units, deduct 5% from above pricing.



#231 or #236



#233 or #238

## HOSPITAL SOILED LINEN CART

with attached polyethylene cover



2-3-4 units on common base connected with coupling bars. Each bar \$10.00.

**SMALL SIZE** 18" long x 12" wide x 35" high overall

#232LC Frame only on 2" rubber swivel casters  
#233LC Frame and 10 oz. canvas bag complete on 2" rubber swivel casters

**LARGE SIZE** 18" long x 18" wide x 35" high overall

#237LC Frame only on 2" rubber swivel casters  
#238LC Frame and 10 oz. canvas bag complete on 2" rubber swivel casters

	1-2	3-5	6 or more
Small #232LC	\$100.00	\$ 95.00	\$ 90.00
Small #233LC	130.00	125.00	120.00
Large #237LC	110.00	105.00	100.00
Large #238LC	140.00	135.00	130.00

For 3" diameter casters add \$10.00 per cart.



SINCE 1972, DISTRIBUTORS OF SPECIALTY ITEMS FOR HOSPITALS, NURSING HOMES, INSTITUTIONS

# LATEST PRODUCTS CORP.

P.O. Box 190 • Syosset, New York 11791 • 1-800-288-3547 • Fax 1-516-367-4714 • email LPCORP@aol.com

## CUBICLE/PRIVACY CURTAINS

Creating a Beautiful, Dignified Environment which Promotes the Healing Process



Bedside Cubicles



Dressing Area

Color swatches available upon request.

### BARJAN CUBICLE CURTAINS FROM LATEST PRODUCTS

- Innovation
- Attention to Detail
- Workmanship

#### Barjan Features:

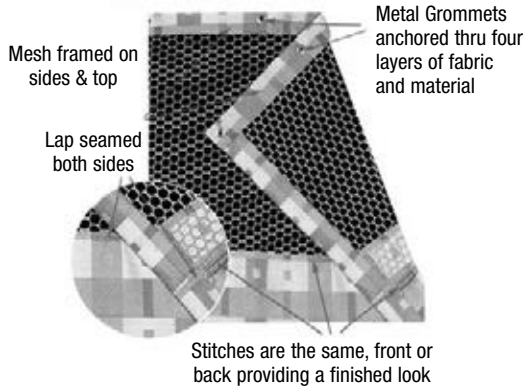

- Framed mesh on three sides with matching cubicle fabric for strength, durability and beauty.
- All bottom hems are weighted at corners and joining seams.
- Washes better and lasts longer. Hangs better, looks better.
- Meets or exceeds JCAHO. Complies with OSHA Standards.
- Thousands of inherently fire-retardant fabrics. Meets or exceeds all fire codes.
- Designed to fit your space.

We make it easy to correctly manufacture your curtains. We will need the following information:

1. Your ceiling height (to make the curtains the proper length top to bottom).
2. Do you require track? If so, what are your track dimensions? Please also include a sketch.
3. Will the track layout interfere with any lights, sprinklers, etc.
4. Is installation required? Note: If track already exists just measure each track leg and ceiling height. Track-to-floor; is track mounted direct to ceiling?

We will provide a quote together with an installation option. Installation is available in most locations nationwide.

Thousands of patterns and colors available. Call Latest Products for full-color catalog.

#### IN ADDITION, WE CAN ALSO SUPPLY:

Shower Curtains, Window Treatments, Bedspreads, Cart Covers, ADA Signage, Ceiling Mounted IV's.

Please call for more information or assistance.



# STAPHCHECK INSTITUTIONAL PILLOWS

## VINYL COVERED PILLOWS AT UNBELIEVABLE PRICES

**RESISTANT TO FLUID—BACTERIA—FIRE—STATIC—  
HYPOALLERGENIC—WIPE CLEAN—TEAR RESISTANT**

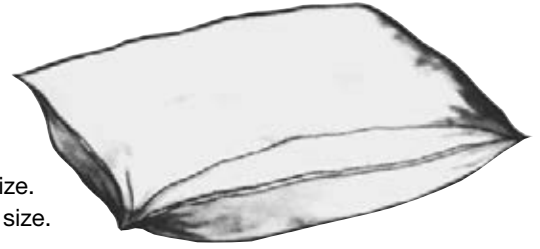

prime polyester fill

- Color White standard, also available in Blue at same price.
- No Quantity Limit. Order as many as you'd like at \$4.00 each for larger size.
- No Quantity Limit. Order as many as you'd like at \$3.75 each for smaller size.
- Save up to 80% of cost of ordinary disposable pillows.
- No laundering or pillow protectors needed.
- Anti-microbial and flame/stain/tear resistant.
- Wipe clean, fluid resistant.
- Hypoallergenic manufactured with prime polyester filling.
- Minimum order – 2 cartons.
- Packed 16 per carton (no broken cartons) for CV27/SDGK20.
- Packed 20 per carton (no broken cartons) for CV18/SDGK18.
- Freight additional.

Packed	Item #	Size	Price
Pack 16/ctn.	<b>CV27/SDGK 20</b>	21" x 27"	\$4.00 each (\$64.00/CTN)
Pack 20/ctn.	<b>CV18/SDGK 18</b>	18" x 25"	3.75 each (\$75.00/CTN)

Please specify White or Blue.  
CV27/SDGK 20 contains 20 ounce prime polyester fill.  
CV18/SDGK 18 contains 18 ounce prime polyester fill.

## BARRIER FABRIC WASHABLE INSTITUTIONAL PILLOWS

- Flame Resistant
- Noiseless
- Anti-Microbial
- Stainless and Odorless
- 100% Polyester Fill
- Available in White or Blue

Packed	Item #	Size	Price
20/ctn.	<b>1825KARE</b>	18" x 25"	\$3.90 each (\$78.00/CTN)
16/ctn.	<b>2127KARE</b>	21" x 27"	\$4.10 each (\$65.60/CTN)

**ACA Striped Pillows available. Refer to our website.**

## Low Priced, High Quality Disposable Single-Use Pillows

- Flame Resistant
- Hypoallergenic
- Economical
- Not Washable
- 100% polyester fill
- Ticking: White polypropylene, non-woven

Packed	Item #	Size	Fill Weight	Price/Carton
20/ctn.	<b>1825DISPLW</b>	18" x 25"	18 ounce	\$52.00/Carton
20/ctn.	<b>2127DISPLW</b>	21" x 27"	20 ounce	58.00/Carton

Packaged 20 pillows per carton only.

**Refer to page 7 for Vinyl Pillow Protectors—protects against bed bugs.**

**Samples of pillows available upon request.**



SINCE 1972, DISTRIBUTORS OF SPECIALTY ITEMS FOR HOSPITALS, NURSING HOMES, INSTITUTIONS

# LATEST PRODUCTS CORP.

P.O. Box 190 • Syosset, New York 11791 • 1-800-288-3547 • Fax 1-516-367-4714 • email LPCORP@aol.com

## FLUID PROTECTIVE HEAT-SEALABLE PATCHING MATERIAL

(Must be applied with heat-sealing machines.)

### FLUID PROTECTIVE MEDICAL BARRIER

**DESIGNED FOR GARMENTS MADE OF RESISTAT, COMPEL AND BLOCKADE FABRICS. EXTEND THE LIFE OF LAUNDRY BAGS AND LINENS, LABCOATS AND SURGICAL GOWNS.**

Laundry Directors and Administrators will appreciate that at long last there is no need to discard or replace costly laundry bags, linens, labcoats, or surgical gowns. By using Maxima Patches, available in pre-cut sizes or on rolls, you can repair tears and imperfections and extend the life of your garments/laundry and linen. Maxima, our fluid protective medical barrier fabric is 100% polyester, OSHA mandated and approved medical barrier to protect against body fluids and blood borne pathogens.

**PRODUCT # PATCH SIZE PACKED PER BOX PRICE PER BOX**

FPB-1	7/8" x 1"	1000/box	\$31/box
FPB-2	7/8" x 1 1/2"	1000/box	\$50/box
FPB-3	7/8" x 2"	1000/box	\$67/box

**PRODUCT # ROLL SIZE PRICE PER ROLL**

FPBR-1	3/4" x 50 yards	\$31/roll
FPBR-2	1" x 50 yards	\$39/roll
FPBR-3	1 1/4" x 50 yards	\$49/roll

Standard colors: Misty Green, Brushed Eyres Green, Ceil Blue, Yellow, Brushed Light Blue or Green. For Blue Compel garments, please specify Cloud Blue. For Blockade, specify Yellow, Misty Green or Ceil Blue. For Resistat garments, specify Brushed Light Blue or Brushed Green.

Other sizes and shapes available.

Please note—**Minimum patch billing \$50**

**Application Procedure:** Apply at 380 degrees for 10 seconds using a heat-sealing machine.

Call for testing samples.

## Alternative to Costly Marking Systems!

**INEXPENSIVELY MARK RESIDENTS' PERSONAL CLOTHING, DOCTORS' COATS, LAB COATS, ETC.**

**ELIMINATE REPETITIVE PEN MARKING BY HAND!**

Use this system by itself or in conjunction with heat seal machines (pages 24 and 25) and heat seal label tape (page 23).

**Each kit consists of:**

- one 14-band, wheel-operated Rubber Stamp enabling you to print any name up to 14 letters per name (each band has 26 letters—numbers also available upon request)
- one two ounce bottle of indelible laundry marking ink
- one stamp pad



STYLE 2 (3/16")

**Example: JOHN SMITH**

Turn the first band to "J", the second band to "O", third band to "H", the fourth band to "N" and so on.

## Custom Embroidered Heat-Sealable Emblem Patches

Use on uniform sleeves or pockets to identify institution, department or name. Available in sizes from 2" to 16". Colorfast threads, borders are merrowed (spun thread) or stitched and laser cut. Up to 7 thread colors available. Available with standard plastic backing for sewing or heat sealable adhesive backing.



To obtain immediate pricing, please call, mail, email or fax us:

1. Sketch indicating size and text copy
2. Color or colors
3. Quantity
4. Border (merrowed or stitched and laser cut)
5. Backing (standard plastic or heat sealable adhesive)

Used by hospitals, nursing homes and institutions nationwide.

**FIVE EASY WAYS TO ORDER:**

1. **By Mail:** P.O. Box 190 • Syosset, NY 11791
2. **Toll-Free:** 1-800-288-3547

3. **By Fax:** 1-516-367-4714
4. **By email:** LPCORP@aol.com

5. **Through our website:** [www.LatestProducts.net](http://www.LatestProducts.net)

# HEAT-SEALABLE PATCHING MATERIAL

(Must be applied with heat-sealing machines.)

**USE YOUR HEAT-SEALABLE MENDING PATCHES AND HEAT SEALING MACHINES AND YOU WILL PROLONG THE LIFE OF BED LINEN, SURGICAL LINEN, COATS AND UNIFORMS.**

**Colors:** Most popular are White, Jade Green, Misty Green, Kilarny Green, Ceil Blue, and Yellow. Also available are Powder Blue, Medium Blue, Postman Blue, Lilac, Black, Burgundy, Teal, Brown, Gray, Charcoal, Navy, Orange, Pink, Red, Spruce Green, Tan. In Twill we have Brown, Gray, Navy, White, Black, Charcoal, Royal Blue, Ceil Blue, Red, Spruce, and Denim.

*Many other colors and twills now available.*

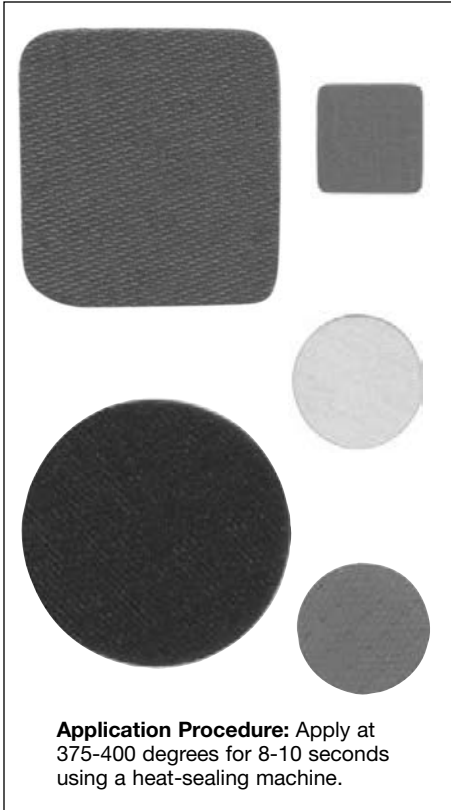

**Application Procedure:** Apply at 375-400 degrees for 8-10 seconds using a heat-sealing machine.

LPC MEND PRE-CUT PATCHES				LPC MEND ROLL PATCHING MATERIAL		
NUMBER OF PIECES PER BOX	SQUARE & RECTANGULAR		PRE-CUT	ROLL		
	Code	Size	Price Per 1000	Code	Size	Price Per Roll
4M	A	1/2" x 1/2"	\$ 9.50	N	1" x 50 Yards	\$18.50
2M	B	3/4" x 3/4"	10.25	O	1 1/4" x 50 Yards	21.75
2M	C	1/2" x 1"	11.25	P	1 1/2" x 50 Yards	27.75
2M	D	1" x 1"	14.50	Q	2" x 50 Yards	36.50
1M	E	3/4" x 2"	19.75	R	3" x 50 Yards	58.75
1M	F	3/4" x 3"	31.00	S	4" x 50 Yards	77.00
1M	G	1 1/2" x 1 1/2"	27.00	<b>Other Sizes Available</b>		
500	H	2" x 2"	48.00	<b>LPC SEALABLE LABEL TAPE</b>		
250	I	3" x 3"	93.00	<b>FOR PRINTING NAMES</b>		
250	J	4" x 4"	175.00			Price Per Roll
1M	K	1" x 3"	35.00	5/8"	x 50 Yards	\$14.75
1M	L	1" x 5 1/2"	70.00	3/4"	x 50 Yards	14.75
<b>Other Sizes Available</b>				1"	x 50 Yards	18.50
<b>ROUND PRE-CUT PATCHES</b>				1 1/4"	x 50 Yards	21.75
2M	BR	3/4"	\$ 10.75	1 1/2"	x 50 Yards	27.75
2M	DR	1"	14.00			
1M	GR	1 1/2"	19.00			
500	HR	2"	48.00			
250	IR	3"	95.50			
<b>Other Sizes Available</b>						

◆◆◆ MINIMUM BILLING \$75.00 ◆◆◆

Call or fax us for free testing samples.

Heat-seal machines on pages 24 and 25. Heat Dye Transfers featured on page 26.

## COMPUTER HEAT-SEALABLE LABEL TAPE

Polycotton or 100% Polyester

Heat-sealable color-coded label tapes provide for an inexpensive marking and tracking system. Patient names, departments, floors, etc. can be identified. For use with form feed printers only. Colors available are white, red, blue, tan, kelly green, orange, pink, lavender, and yellow. One thousand labels per roll. Must be adhered with heat-sealing machines. Polyester material ideal for identifying undergarments.

LABEL SIZE	CATALOG NUMBER	PRICE PER THOUSAND POLYCOTTON	PRICE PER THOUSAND POLYESTER
1" x 3-1/4"	#TD-1325	\$56.00/Roll	\$69.00/Roll
5/8" x 3-1/4"	#TD-58325	41.00/Roll	53.00/Roll
5/8" x 2-1/2"	#TD-58250	40.00/Roll	52.00/Roll
2/3" x 3-1/4"	#TD-23325	41.00/Roll	53.00/Roll
1/2" x 2-1/2"	#TD-50250	40.00/Roll	52.00/Roll

Samples of patching material available upon request.





SINCE 1972, DISTRIBUTORS OF SPECIALTY ITEMS FOR HOSPITALS, NURSING HOMES, INSTITUTIONS

# LATEST PRODUCTS CORP.

P.O. Box 190 • Syosset, New York 11791 • 1-800-288-3547 • Fax 1-516-367-4714 • email LPCORP@aol.com

## HEAT SEALING MACHINES ELECTRICALLY OPERATED

*Outstanding Value!*

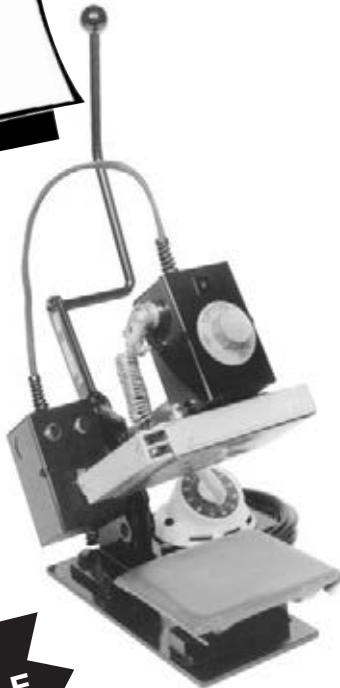

### LPC #1000

Ideal for small Hospitals, Nursing Homes and Correctional Facilities!

- Thermostatically controlled heat
- Available with top & bottom heat—each with separate dial thermostats
- Excellent for applying transfers, initials, emblems, and patches
- No installation required
- Simplified operation
- Timer calibrated in seconds
- Silicone rubber pad on bottom table for even pressure
- Requires little maintenance
- Top & bottom teflon covers for non-sticking surface

4" x 5" Presshead	<b>\$685.00</b>	4" x 6" Presshead	<b>\$720.00</b>
5" x 6" Presshead	<b>765.00</b>	4" x 8" Presshead	<b>750.00</b>
6" x 8" Presshead	<b>820.00</b>	4" x 10" Presshead	<b>810.00</b>
6" x 12" Presshead	<b>905.00</b>	4" x 12" Presshead	<b>815.00</b>

Top and Bottom Heat available at additional \$225.00.  
Uses 110 volt, weighs 30 pounds.

**Many other platen sizes available, up to 13" x 13"**

**ADDITIONAL MODELS AVAILABLE ON OUR WEBSITE**



### LPC #3000

Excellent for applying: Appliques, Cut-outs, Emblems, Initials, Patch Mending, Embroidery, Label Identification, Elbow Patches, Heat Dye Transfers, Monograms, Cloth Fabric Coated for Heat Sealing. Self adjusting pressure according to material thickness.

For larger work volume. Semi-Automatic:

- Handle depressed manually
- Head opens automatically after sealing cycle
- Dial thermostat (200° to 550° F)
- Automatic 60 second reset timer
- On/Off pilot indicator light
- Heat indicator light
- Safety release in handle
- Top Heat
- Silicone pad and teflon cover top and bottom

5" x 6" Presshead	<b>\$1475.00</b>	6" x 7" Presshead	<b>\$1595.00</b>
6" x 9" Presshead	<b>1650.00</b>	4" x 12" Presshead	<b>1635.00</b>
6" x 12" Presshead	<b>1760.00</b>	6" x 10" Presshead	<b>1685.00</b>
8" x 10" Presshead	<b>1780.00</b>	10" x 10" Presshead	<b>2080.00</b>

Top and Bottom Heat available at additional \$325.00.  
Uses 110 volt, weighs 60 pounds.

**Many other platen sizes available, up to 13" x 13"**

**FOR FABRIC EMBLEMS (PRINTED OR EMBROIDERED) ORDER TOP AND BOTTOM HEAT**

**TERMS: 2% ten days, net 30, F.O.B. Factory. We prepay shipping and add to invoice.**

# MANUAL HEAT-SEAL MACHINES

Used for applying transfers, heat sealable patches and repairing garments.



**LPC #10**  
Manual Top Heat Seal Machine  
**\$495**

- 13" x 8" x 14" overall size.
- 4" x 6" heating surface.
- Stainless steel base.
- On and off switch.
- Pilot light.
- Adjustable thermostat.
- Digital timer.
- 400 Watts.
- 4 Amp, 60 cycle, 110 Volt AC.
- Weighs only 25 lbs.

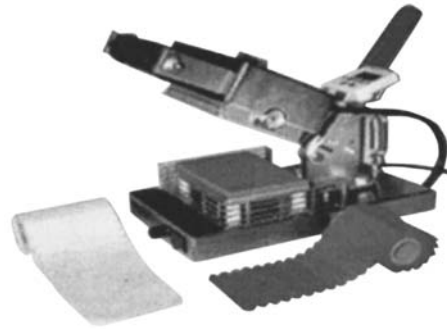

**LPC #2-HH**  
Manual Top and Bottom Heat Seal Machine  
**\$665**

- 13" x 8" x 14" overall size.
- 4" x 6" heating surface.
- 800 Watts, 60 cycle, 110 Volt AC, 8 amp.
- Top and bottom heat with heat indicators.
- Adjustable thermostats.
- Digital timer, heat gauge.
- Pressure control is preset for all specific needs.
- Non-skid rubber feet.
- Requires no air to operate.
- Completely portable unit.
- Weighs only 26 lbs.

# AIR OPERATED PRESSHEAD

**#LPC 7000**



Features Top and Bottom Heat

- Completely air operated (needs 70-100 PSI, 7.5 up to 15 Amps, 110 Volts)
- Fully automatic. Closes and opens by air.
- Push button operated.
- Dial Thermostat (200° to 550° F)
- Automatic reset timer.
- Electronic safety guard.
- Indicator lights show on/off status and heat setting.
- Pressure gauge and air filter.
- Silicon pad and teflon cover.
- Safe two hand control.
- Stands available. Please inquire.

## Select your Presshead

6" x 7"	\$3335.00	7" x 10"	\$3545.00
6" x 8"	3425.00	7" x 16"	4125.00
6" x 9"	3520.00	8" x 10"	3785.00
6" x 12"	3555.00	10" x 12"	4125.00
7" x 8"	3535.00		

Uses 110 volts, weighs 80 pounds

### MANY OTHER PLATEN SIZES AVAILABLE

Perfect for fabrics as LPC 7000 has top and bottom heat.  
Prices include crating charge.

Please provide us with your email for monthly specials and new product bulletins.



## HOW DIRECTORS OF LAUNDRY/LINEN REDUCE THEFT AND LOSS OF VALUABLE PROPERTY:

# HEAT DYE TRANSFERS

## Kaumographs to Mark Linen and Gowns

This is the easiest, most inexpensive method of marking and identifying linen and garments. Our **HEAT DYE TRANSFERS** are easily applied with 3 to 5 seconds of heat from any heat sealing machine. Once applied, they will withstand multiple launderings and deter pilferage greatly.

We can supply you with the logo and message you want, in the shape, color and wording of your choice.

**Call for free testing samples.**

Pricing is per square inch of transfer. To find square inches, please multiply length and width of your design or transfer.

PRICE PER THOUSAND					
Square Inches	10,000	25,000	50,000	100,000	Initial Orders Cost of Engraving
For transfers smaller than 6 square inches, use the 6 square inch pricing.					
6	\$21.00	\$20.85	\$20.75	\$20.50	\$100.00
7	22.00	21.85	21.75	21.50	105.00
8	23.00	22.85	22.75	22.50	110.00
9	24.00	23.85	23.75	23.50	115.00
10	26.00	25.85	25.75	25.50	120.00
11	29.00	28.85	28.75	28.50	125.00
12	31.00	30.85	30.75	30.50	130.00
14	35.00	34.85	34.75	34.50	135.00
16	37.00	36.85	36.75	36.50	150.00
18	40.00	39.85	39.75	39.50	175.00
20	42.00	41.85	41.75	41.50	200.00

**We can supply printed or embroidered labels, names, titles, departments, etc. Refer to page 22.**

Engraving plates are kept for 2 years. If transfers are not reordered within 2 years, a new engraving charge may apply.

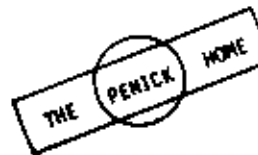

**We can make transfers up to 7 1/2" x 7 1/2"**

For sizes of two to five square inches, use prices of six inch column.

COLORS: black, blue, green, red, white and others. Note: black will be supplied unless otherwise requested.

For two color transfers, double the per thousand transfer cost and double the engraving cost.

Engraving cost charged on first order only.

Heat Dye Transfers are put up on continuous roll form. If sheeting (individual cut) is desired, add \$4.00 per thousand to cost of transfers.

Application of Heat Dye Transfers: 3 to 5 seconds, 350-400 degrees heat. Maximum pressure.

**Samples of Heat Dye Transfers available upon request.**

# SEAMLESS ONE PIECE MOLDED POLYMER TRUCKS

SEE FOLLOWING PAGES FOR  
PRICES AND SPECIFICATIONS



WASHROOM  
TRUCKS  
47P Series



FLARE  
TRUCKS  
24P24



UTILITY  
TRUCKS  
50P Series

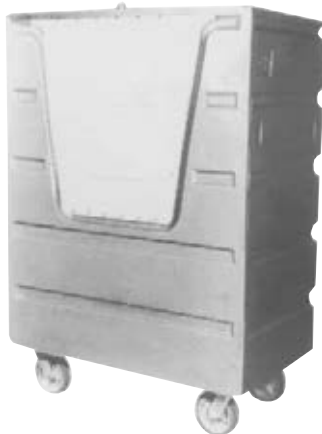

SECURITY TRUCK  
#72P/PSL6  
(with door & lid)



LINEN TRUCK  
#640001S



90 PSL Series  
95 PSL Series



ROUNDRIPPER  
WITH SHELVES  
87P Series  
88P Series  
90P-91P Series  
95P Series



BULK DELIVERY  
TRUCKS  
70P Series

SPECIFICATIONS AND PRICES FOLLOW

Our molded trucks are in use at thousands of hospitals, institutions, hotels/motels, and correctional facilities.





SINCE 1972, DISTRIBUTORS OF SPECIALTY ITEMS FOR HOSPITALS, NURSING HOMES, INSTITUTIONS

# LATEST PRODUCTS CORP.

P.O. Box 190 • Syosset, New York 11791 • 1-800-288-3547 • Fax 1-516-367-4714 • email LPCORP@aol.com

## POLYMER BULK AND CONVERTIBLE TRUCKS LATEST PRODUCTS HAS THE FINEST AND MOST COMPLETE LINE OF MOLDED TRUCKS AVAILABLE

SPECIFICATIONS AND PRICES ON FOLLOWING PAGES



No. 72P Bulk Truck  
(without door & lid)



No. 70P  
Bulk Truck



No. 64P Bulk Truck



No. 90P  
Roundtripper  
Convertible  
Shelf Truck



No. 87P Roundtripper  
Convertible  
Shelf Truck



No. 72P/PSL6 Security Truck  
(with door & lid)

## OPTIONS/ACCESSORIES

We offer a complete line of accessories  
and options for all our carts.

- 3/4" drain valves
- Cart covers – see pages 10-11
- Wide variety of tow hitches
- Wheel brakes
- Card holders
- Swivel locks
- Larger industrial casters
- Polyurethane casters
- Hinged lids
- Plastic bases
- Cart liners/caps
- Spring platforms

## PUSH N' PULL HANDLE



Model # PP03 \$149.00

- A great back saver
- Eliminates bending
- Less effort to push
- Easy to install
- Easy to clean
- Fits most poly trucks and vinyl or canvas trucks. Please specify when ordering.

All carts and trucks subject to a 25% restocking fee plus freight charges  
for returned items for any reason except manufacturer's defects.

# PRICE LIST

**MATERIALS: VIRGIN POLYMER—CHOICE OF COLORS  
OR  
RECYCLED POLYMER—NO COLOR CHOICE AVAILABLE**

**All recycled polymer carts are eco friendly!**

**Please specify color and caster arrangements described below.**

Dimensions in inches

Model	Color Choice Available Virgin Polymer	No Color Choice Available Recycled Polymer	Capacity		Outside		Depth	Overall Height	Casters		Plastic Base Available
			Cu. Ft.	Bu.	Length	Width			Arrangement	Data	
<b>70P Bulk Truck*</b>	525	464	36	29	48	28½	47	54½	A, B	6-in. Rubber	<b>X</b>
<b>71P Bulk Truck</b>	395	355	41	33	40	26	68	75½	A, B	6-in. Rubber	
<b>72P Bulk Truck*</b>	572	491	48	38	48	28½	59	66½	A, B	6-in. Rubber	<b>X</b>
<b>73P Bulk Truck</b>	611	519	42	34	41	28½	64	72	A, B	6-in. Rubber	
<b>74P Bulk Truck*</b>	530	446	32	26	41	28½	51	59	A, B	6-in. Rubber	
<b>75P Bulk Truck</b>	562	484	37	30	38	28½	60	67½	A, B	6-in. Rubber	
<b>76P Bulk Truck</b>	588	505	46	37	42	28½	68	76	A, B	6-in. Rubber	
<b>77P Bulk Truck</b>	536	464	33	27	41	30	51	59	A, B	6-in. Rubber	
<b>78P Bulk Truck</b>	723	619	70	56	52½	43½	56	65	A, B	6-in. Rubber	
<b>79P Bulk Truck</b>	738	640	61	49	53½	37	56	65	A, B	6-in. Rubber	
<b>81P Convertible Shelf Truck</b>	894	784	42	34	47½	26	61½	69½	A, B	6-in. Rubber	
<b>84P Convertible Shelf Truck</b>	931	796	45	37	54½	27½	54	62	A, B	6-in. Rubber	
<b>85P Convertible Shelf Truck</b>	1014	868	49	40	59½	27½	54	64½	A, B	8-in. Rubber	
<b>86P Convertible Shelf Truck</b>	915	790	52	42	55¾	26	63½	72½	A, B	8-in. Rubber	
<b>90P Convertible Shelf Truck</b>	733	624	38	32	48	28½	54	62	A, B	6-in. Rubber	<b>X</b>

\*Models 70P, 72P and 74P now available with optional spring platform. Add \$99 for platforms.

Selected trucks now available with a plastic base if desired (same price). Standard base is made of powder coated steel for strength and rust resistance. Plastic base protects against corrosion or harsh chemical agents.

Quantity discounts available. Please inquire.

**Trucks featured on this page are supplied with drain holes unless you specify to omit.**

**Drain valves instead of drain holes are \$15 extra per truck.**

### Colors

Pink	Purple	Lime Green
Wine	Brite Lemon	Jade Green
Red	Brilliant Orange	Forest Green
Powder Blue	Beige	Honey Gold
Cadet Blue	Chocolate Brown	Metallic Silver (Gray)
Royal Blue	Black	

### CASTER ARRANGEMENTS:

- A: Swivel at four corners**
- B: Swivel at one end, fixed at other**
- C: Diamond pattern, fixed on sides, swivel at ends**
- D: Six casters—swivel at four corners, two fixed in middle**

*Please verify that truck selected will fit through doors*

**All carts and trucks subject to a 25% restocking fee plus freight charges for returned items for any reason except manufacturer's defects.**



SINCE 1972, DISTRIBUTORS OF SPECIALTY ITEMS FOR HOSPITALS, NURSING HOMES, INSTITUTIONS

# LATEST PRODUCTS CORP.

P.O. Box 190 • Syosset, New York 11791 • 1-800-288-3547 • Fax 1-516-367-4714 • email LPCORP@aol.com

## LARGE SELECTION OF POLYMER TRUCKS IDEAL FOR

- Hospitals
- Nursing Homes
- Assisted Living Facilities
- Correctional Institutions
- Lodging/Hospitality
- Construction Industry
- Spas/Resorts

**SPECIFICATIONS AND PRICES ON NEXT PAGE**



No. 50P-16 Utility Truck  
Also available in a recycling model—  
please inquire



No. 25P24 "Rising Platform" Truck



No. 24P24 Nestable Flare Truck



No. 44P Utility Truck



Molded Hamperstand  
(see page 13)



No. 47P Utility Washroom Truck—  
Tapered Hopper Bottom



No. 41C Elevated Truck



No. 54P Utility Truck



No. 75P Sling Container



No. 54P-40E Utility Truck  
with Cut-Out



No. 27P14 Small-Piece Truck

### CASTER ARRANGEMENTS

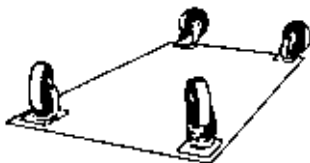

A. Swivel all four corners.

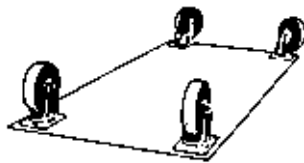

B. Swivel at one end, fixed at other end.  
(Not recommended for Models  
24P24 or 47P.)

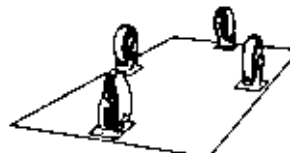

C. Diamond pattern: fixed on sides, swivel on ends.  
(Not recommended for Models 24P24,  
47P, 70 Series or 80 Series.)



D. Four swivel corner mount  
two fixed in middle.

*Note: All swivel casters have double ball bearing raceways.*

**TERMS: 2% ten days, net 30, F.O.B. Factory. We prepay shipping and add to invoice.**

# PRICE LIST

Please specify color and  
caster arrangement  
shown below. (No color  
choice on recycled polymer.)

No drain holes unless you specify.

Dimensions below are in inches.

Model	Color Choice Available Virgin Polymer	No Color Choice Available Recycled Polymer	Capacity		Outside		Depth	Overall Height	Casters	
			Cu. Ft.	Bu.	Length	Width			Arrangement	Data
24P24 Flare Truck	\$433	\$390	30	25	64	40	25½	32	A, B	5-in. Rubber
25P24 Rising Plat. Truck	789	723	23.5	19	66	35	24	30½	D	5-in. Rubber
27P14 Small Piece Truck	426	370	16.5	13	56	23	25	30½	A, B	5-in. Rubber
28P18 FWI Rising Plat. Tr.	692	654	18	16	56	24	25	31	A, B	5-in. Rubber
41Cx2 Elevated Truck	123	X	2	1.75	25	17	12	29	A	3-in. Rubber
41Cx4 Elevated Truck	140	X	5.5	4.25	30	23	18	29	A	3-in. Rubber
41Cx6 Elevated Truck	156	X	7.5	6	32	23	21	29	A	3-in. Rubber
44P-12 Utility Truck	250	230	11.5	10	38	29	27	34	A, B, C	5-in. Rubber
44P-14 Utility Truck	291	241	13	11	44	31	25½	32	A, B, C	5-in. Rubber
44P-16 Utility Truck	320	281	17.5	14	49	31½	27½	34½	A, B, C	5-in. Rubber
44P-18 Utility Truck	407	357	20.5	17	54	29½	27	34	A, B, C	5-in. Rubber
47P Washroom Truck	457	408	14.5	12	48½	31	30	32	A, B	5-in. Rubber
50P-12 Utility Truck	283	249	13	11	35½	24½	28	34½	A, B, C	5-in. Rubber
50P-14 Utility Truck	340	297	19	16	39½	28½	32	38½	A, B, C	5-in. Rubber
50P-16 Utility Truck	360	311	21	18	43½	28½	32	38½	A, B, C	5-in. Rubber
50P-16 Molded Hinged Slide-on Lid	168	X	—	—	—	—	—	—	—	—
50P-16 Aluminum Hinged Slide-on Lid	242	X	—	—	—	—	—	—	—	—
54P-16 Utility Truck	370	331	18.5	15	42½	28½	28	34½	A, B, C	5-in. Rubber
54P-16 Molded Hinged Slide-on Lid	168	X	—	—	—	—	—	—	—	—
54P-16 Aluminum Hinged Slide-on Lid	242	X	—	—	—	—	—	—	—	—
54P-18 Utility Truck	422	367	22.5	18	53½	28½	27	33½	A, B, C	5-in. Rubber
54P-18 Aluminum Hinged Slide-on Lid	252	X	—	—	—	—	—	—	—	—
54P-26 Utility Truck	495	437	33	27	53½	28½	39	45	D	5-in. Rubber
54P-40 Utility Truck	613	540	40	32	76	40½	25	32	D	5-in. Rubber
54P-47 Utility Truck	966	800	58	47	71	46	35½	43	D	6-in. Rubber
75P Sling Container	216	179	13.5	11	31½ (dia.)		36	43	A	5-in. Rubber
100P Sling Container	220	183	15.5	12.5	34 (dia.)		35	42	A	5-in. Rubber
54P-40E Truck - cutout	602	529	40	32	76	40½	25	32	D	5-in. Rubber

**All recycled polymer carts are eco-friendly!**

## Colors

Pink	Purple	Lime Green
Wine	Brite Lemon	Jade Green
Red	Brilliant Orange	Forest Green
Powder Blue	Beige	Honey Gold
Cadet Blue	Chocolate Brown	Metallic Silver (Gray)
Royal Blue	Black	

## CASTER ARRANGEMENTS:

- A:** Swivel at four corners
- B:** Swivel at one end, fixed at other
- C:** Diamond pattern, fixed on sides, swivel at ends
- D:** Six casters—swivel at four corners, two fixed in middle

Quantity discounts available. Please inquire.

*Please verify that truck selected will fit through doors*

Latest Products is now on Facebook and Twitter!





SINCE 1972, DISTRIBUTORS OF SPECIALTY ITEMS FOR HOSPITALS, NURSING HOMES, INSTITUTIONS

# LATEST PRODUCTS CORP.

P.O. Box 190 • Syosset, New York 11791 • 1-800-288-3547 • Fax 1-516-367-4714 • email LPCORP@aol.com

**IDEAL FOR  
REMOVAL OF  
BAGGED AND  
INFECTIOUS  
WASTE**

## SECURITY BULK DELIVERY/ PICK-UP TRUCK

**Use for Delivery of Clean Linen or Pick-up  
of Soiled/Contaminated Linen or Waste.**

Our bulk linen trucks are dependable workhorses for hospitals, nursing homes, correctional institutions, commercial laundries and companies serving these industries.

- Ergonomic cutaway design speeds loading and unloading
- Closure secures goods during transport and storage
- Rugged polyethylene construction resists bumps, scratches and scrapes
- UV-resistant, waterproof body thrives in punishing indoor/outdoor conditions
- Powder-coated, full-perimeter steel base for strength, rust resistance\*
- Front door with hasp drops down for front loading
- Top lid is split for optional top loading
- When closed, lid locks with closed front door for security using your own padlock
- Easy rolling 6" rubber casters
- Drain holes can be eliminated—drain valve is available at \$15/truck



Lid closed



Lid open

Front door open

### AVAILABLE COLORS (Door and lid color are white)

Pink	Cadet Blue	Lime Green	Brite Lemon
Wine	Brilliant Orange	Jade Green	Forest Green
Red	Beige	Royal Blue	Honey Gold
Powder Blue	Chocolate Brown	Purple	Metallic Silver (Gray)
	Black		

**our  
#1  
Selling Truck**

	Item No.	Cu. Ft.	Bu.	Length	Width	Overall Depth	Height	Price
<b>MOST POPULAR</b> →	72P/PSL6*	48	38	48	28½	59	66½	\$795.00
<b>SMALLER SIZES</b> {	70P/PSL6*	36	29	48	28½	47	54½	760.00
<b>AVAILABLE</b>	74P/PSL6	32	26	41	28½	51	59	755.00

Inquire about quantity discounts

\*Trucks supplied with 14 gauge powder coated steel base (standard). Models 72P/PSL6 and 70P/PSL6 are now also available with a plastic base (protects against corrosion and harsh chemicals) if desired at same price. Please specify if you prefer plastic.

All above with 6" casters. For recycled polymer, (no color choice) deduct \$50.00 from above prices. Available with 8" casters which increase overall height by 2 inches. Add \$30.00 per truck.

### CASTER ARRANGEMENTS

**A—Swivel on four corners    B—Two rigid and two swivel on each end**

**PLEASE SPECIFY IF YOU WANT DRAIN HOLES OMITTED**

**Drain valve—add \$15.00 per truck.**

**Delivery trucks if returned are subject to a 25% restocking fee plus freight charges incurred.**

**Please verify colors, sizes and options carefully when ordering.**

# LINEN DELIVERY TRUCKS TO DELIVER CLEAN LINEN AND PICK UP SOILED LINEN

Our 90P series bulk linen trucks feature a novel roundtrip design that enables hospitals, nursing homes, commercial laundries, and laundry service companies to use the same cart for delivering finished, folded goods and for picking up and returning soiled linens. The 90P comes with a choice of wire or plastic horizontal shelves that after delivery, one person can easily slide into a vertical position for use as a bulk laundry cart.



90P Plastic Shelves Shelves positioned to collect dirty linen. Open top

## CHOOSE FROM TRADITIONAL WIRE OR PLASTIC SHELVES. 90P ROUNDTRIPPER OPEN TOP WITH REMOVABLE SHELVES

**Pricing:** 90P/W Truck with 2 Wire Shelves \$725.00  
90P/P Truck with 2 Plastic Shelves \$725.00

**BOTH MODELS AVAILABLE IN RECYCLED POLYMER \$640.00**

**Options:** Additional Wire Shelf (2 included) Add \$ 90.00  
Hinged 2 Wire Shelves Add \$120.00  
Hinged 3 Wire Shelves Add \$125.00  
Recessed Handles Add \$ 25.00  
Card Holder Add \$ 25.00

**When ordering, please specify wire or plastic shelves, metal or plastic base. Please see bottom of page for available colors.**



90P Wire Shelves Shelves positioned to deliver clean linen. Open top

### ROUNDTRIPPER

Capacity		Outside			Overall Height	Casters	
Cu. Ft.	Bu.	Length	Width	Depth		Arrangement	Data
38	32	48	28½	54	62	A, B	6-in. Rubber

Please specify casters: A (4 swivel) or B (2 swivel/2 rigid).

Comes with powder coated (standard) metal base or plastic base (same price). Plastic base protects against corrosion or harsh chemical agents. UV resistant, waterproof body, thrives in indoor/outdoor conditions.

## LINEN DELIVERY TRUCK WITH PLASTIC TOP AND PLASTIC SHELVES

### 90PL CLEAN LINEN DELIVERY TRUCK WITH HARD TOP

**Pricing:** 90PL Truck with 2 Plastic Non-Removable Shelves and Key Lockable Doors \$1095.00  
90PL Truck with 2 Plastic Non-Removable Shelves and Vinyl Flap Closure \$ 950.00

**Options:** Recessed Handles Add \$ 25.00  
Card Holder Add \$ 25.00

**90PL: Dimensions are same as 90P above. 90PL has a permanent hard top.**

Available with either metal base (standard) or plastic base (same price). Key lockable doors keep linens clean and dry and provide for security.



90PL shown with key lockable heavy duty doors instead of flap.



90PL with flap and no doors. Shown with front flap in open position.

### 90PL Clean Linen Delivery Truck with Hard Top and with choice of molded doors or vinyl flap.

Our 90PL series is the first bulk linen delivery truck that comes with style, class and luxury appeal. It is a high-capacity, attractive clean linen delivery truck designed for hospitals, nursing homes, upscale hotels, resorts, and other properties where a premium is placed on visual appeal as well as durability and longevity.

**Colors available for 90P and 90PL: Pink, Wine, Red, Powder Blue, Cadet Blue, Royal Blue, Purple, Brite Lemon, Brilliant Orange, Beige, Chocolate Brown, Black, Lime Green, Jade Green, Forest Green, Honey Gold, Metallic Silver (Gray)**

Please specify casters: A (4 swivel) or B (2 swivel/2 rigid).

All carts and trucks subject to a 25% restocking fee plus freight charges for returned items for any reason except manufacturer's defects.



SINCE 1972, DISTRIBUTORS OF SPECIALTY ITEMS FOR HOSPITALS, NURSING HOMES, INSTITUTIONS

# LATEST PRODUCTS CORP.

P.O. Box 190 • Syosset, New York 11791 • 1-800-288-3547 • Fax 1-516-367-4714 • email LPCORP@aol.com



Model 90PSL

## BULK LINEN ROUNDTripper TRUCKS WITH KEY LOCKABLE DOORS AND OPENING TOP

Provide safe transport! Discourage pilferage!  
Ideal for hotels, spas, resorts, lodges and healthcare facilities.

- Two repositionable shelves slide easily from horizontal to vertical positions to convert from clean linen delivery to soiled return.
- Doors close and lock with shelves in either position.
- Recessed, molded-in handles are placed inside the swiveling end for easy, safe movement.
- Open doors swing 270 degrees and snap into sides of cart to maintain sleek profile and fit into tight spaces.
- Double-wall, molded doors with high-grade stainless steel latch and security lock safeguard goods.
- Split hinged top opens for ergonomic access to linens, seals shut and locks for over the road transport and security.
- Double wall construction withstands repeated use.
- Industrial grade 6" casters withstand constant, punishing operation.
- New all-plastic base accommodates 600 lbs. without crumpling, cracking or deteriorating. Can be used in automatic cart washers.
- Choose new plastic or rust-resistant powder-coated steel base.

\*For color selection please see below.

Please specify casters: 4 swivel or 2 swivel/2 rigid.

Model 90PSL \$1,189.00 per cart					
Capacity (Cu. Ft.)	Capacity (Bu.)	Width (Outside)	Length (Outside)	Depth	Height (Overall)
38.0	32	28"	48"	54"	62"

Also available: Model 95PSL with 3 plastic shelves; 49 cubic foot capacity; 58" L x 30 3/4" W x 63 3/4" Deep x 72" Overall Height. \$1,725.00 per cart

## HEAVY DUTY ROUNDTripper TRUCK

The new 100P bulk linen truck features an internal rib design and steel-top ring that nearly doubles the strength, structural integrity and load bearing capacity of the cart.

- Handles overloads to 700 lbs. – even above the upper rim of the cart.
- Smart design and sturdy shelves prevents shelf collapse.

Choose non-removable wire shelves for one-way use or repositionable plastic shelves (please specify—same price) for round-trip use. Made of durable polyethylene – comes with industrial grade 6" casters. Durable body on either plastic base or powder-coated full perimeter steel base. Please specify. **Same dimensions as 90PSL (above).**

\*For color selection please see below.

Please specify casters: 4 swivel or 2 swivel/2 rigid.

Model 100P \$949.00 per cart

Recessed Tow Hitch Available with Steel Base – Add \$40



Model 100P

Two plastic shelves included; shelves shown positioned to collect dirty linen. Open top.

## ECONOMY CONVERTIBLE ROUNDTripper SHELF TRUCKS

Your Choice of Removable or Permanently Hinged Wire Shelves. Open Top.  
Avoid Lost or Misplaced Loose Shelves by Using Permanently Hinged Shelves.

Please specify casters: A (4 swivel) or B (2 swivel/2 rigid). For color selection see below.



Model	Removable Shelves		Hinged Shelves Add	Capacity		Outside		Depth	Overall Height	Casters	
	*Virgin Polymer	Recycled Polymer		Cu. Ft.	Bu.	Length	Width			Arrangement	Data
	87P	\$835		\$735	\$75	45	37			60	22
88P	760	665	75	37	30	48	22	60	68	A, B	6-in. Rubber
91P	775	680	75	44	38	48	28 1/2	60	68	A, B	6-in. Rubber
92P	790	680	75	44	38	48	28 1/2	60	68	A,B	6 in. Rubber
95P	925	850	75	49	40	60	28 1/2	60	70	A, B	8-in. Rubber

Handles: \$25 each. Card Holder: \$25.00. Cart covers – see pages 10 - 11.

\*Colors available: Pink, Wine, Red, Powder Blue, Cadet Blue, Royal Blue, Purple, Brite Lemon, Brilliant Orange, Beige, Chocolate Brown, Black, Lime Green, Jade Green, Forest Green, Honey Gold, Metallic Silver (Gray)

TERMS: 2% ten days, net 30, F.O.B. Factory. We prepay shipping and add to invoice.

# SECURITY BULK DELIVERY/PICK-UP TRUCK

IDEAL FOR DELIVERING CLEAN LINEN AND PICK-UP OF SOILED LINEN OR OTHER WASTE

Our newest security bulk delivery/pick-up truck, the **72S/SSL6** with rounded corners and larger inner ribs, combined with a recessed front door and top lid is especially suited for commercial laundries. This new ergonomically designed model has superior strength, durability, versatility, and security. It has an all new lockable, rotationally molded roof and front cover to prevent theft. The cart is leakproof so it may be transported and left outside. Ideal for commercial laundries, hospitals, nursing homes, resorts, health clubs, and the food industry.

Additional features are:

- Ergonomic cutaway design speeds loading and unloading
- Durable lid closure secures goods during transport and storage
- Rugged polyethylene construction resists bumps, scratches and scrapes
- Rotationally molded, full-perimeter, weatherproof poly base for strength and long life
- Large selection of industrial grade casters and arrangements (6" rubber standard)
- Optional tow hitches, brakes, hand holds are available
- 48 cubic foot capacity; 34 bushel capacity; 48" L x 28 1/2" W x 59" Deep x 66 1/2" Overall Height

Item #**72S/SSL6** with front door and split top lid (hinged in center) **\$845**

Item #**72S/SSL6H** with front door and one-piece hinged top lid **\$805**

Also available with NO front door and NO lid, model #**72S** **\$575**

**Note: Front Door and Lid are white unless you purchase 10 or more units.**

**If 10 or more units are purchased, Front Door and Lid can match the truck body color.**

Please specify 4 swivel 6" casters (arrangement A) or 2 swivel/2 rigid 6" casters (arrangement B).

Add \$30 per cart for 8" casters.

Add \$15 for bottom drain valve, please specify if you want bottom drain holes omitted.

Add \$25 for hand holds.

**\*Colors available are listed at bottom of page. For recycled polymer—deduct \$50 from above prices.**



Shown with top lid and front door open

72S Series  
34 bushel capacity

## 101P ROUNDTRIPPER WITH PLASTIC NON-REMOVABLE SHELVES 37 BUSHEL CAPACITY, YET IDEAL FOR NARROW SPACES

The all new **101P** is the most modern **ROUNDTRIPPER** cart available in the industry today. It features a breakthrough shelf conversion system that enables **one person** to switch the shelves from its horizontal clean linen delivery position to its vertical soiled linen return position **WITHOUT** removing the shelves. Since this truck is narrow (only 24" wide), it can fit up to four across in many trailers. The all plastic 101P is molded as a single unit, meaning there are no welds and no metal to weaken or rust over time. **Just introduced—102P with 600 lb. capacity available at \$775 per unit.**

Additional features are:

- Payloads up to 800 lbs.
- Weatherproof (optional covers, too)
- Industrial grade 6" rubber casters (8" also available)
- Costs less than metal carts
- In addition to our traditional colors listed below, the 101P is available in Sandstone or Gray Granite
- 46 cubic foot capacity: (37 bushel) 60 1/2" L x 24" W x 63 1/2" Deep x 71 1/4" Overall Height



Virgin Polymer—\$850 per cart  
Recycled Polymer—\$800 per cart



Clever hinge converts shelves to vertical, solid return position in seconds.

Please specify 4 swivel 6" casters (arrangement A) or 2 swivel/2 rigid 6" casters (arrangement B).

**\*Colors available: Pink, Wine, Red, Powder Blue, Cadet Blue, Brilliant Orange, Beige, Chocolate Brown, Lime Green, Jade Green, Royal Blue, Purple, Brite Lemon, Forest Green, Honey Gold, Metallic Silver (Gray), Black**

Quantity discounts available. Please inquire.





## SECURITY LINEN EXCHANGE TRUCK

### SELF-STORING ROLL-TOP DOOR

#### Roll-Top Security Truck Model #640001S

- **Pilfer-Proof.** Secure containment prevents pilferage; lowers replacement costs. Patented white roll-top tambour door is self-storing; no hinges to interfere with storage and transport, even when open.
- **No More Cart Covers.** Goods stay sanitary and secure under the strong roll-top tambour door—made from the same durable polymers that resist weather and cracking in vinyl windows.
- **Lockable.** Rugged hardened steel hasp can lock door tight. Hidden metal reinforcements add strength and security.
- **Adjustable shelving.** Chrome-plated, heavy-duty wire or solid stainless steel; as many as needed, where needed.
- **Durability.** Seamless, one-piece, molded heavy-duty polyethylene; resists cracking and breaking. Industrial strength, non-marring 8" casters and steel base. Secure, rugged and adaptable.



Lockable steel hasp can lock door tight.



Model	Capacity	Outside Dimensions			Overall Height	Casters	Shipping Weight
		L	W	Depth			
<b>640001S</b>	48 cu. ft.	50"	29"	59"	69"	8"	200 lbs.
# <b>640001S</b> including two chrome plated shelves				\$1,290.00			
<b>Options:</b>							
Additional shelves:		Chrome Plated		\$ 95.00			
		Stainless Steel		160.00			
Hand Holes (two each side) per truck				25.00			
Card Holder				30.00			
3/4" Drain Valve for this model				45.00			

Please specify caster arrangement: 4 swivel or 2 swivel/2 rigid

**Body Colors Available:** Apple Red, Royal Blue, Cadet Blue, Beige, Orange, Silver Gray, Forest Green, Jade Green, Violet, Yellow, Chocolate Brown, White, Gray, Black.

Returns of security linen trucks are subject to a 25% restocking fee plus freight charges incurred.

## MODEL 3000 UTILITY POLY SANITARY CART with Three Shelves



**Ideal for Linen,  
Laundry, Medical  
Supplies**

Lightweight, yet durable, easy rolling 30" length x 23" wide x 52" high, 15 cu. ft. capacity, four 5" swivel wheels, features a 5" deep recessed top tray, 3 shelves, two of which are removable. Cart is dent-proof, washable, rust proof, available in many colors.

**Colors Available:** Apple Red, Royal Blue, Cadet Blue, Beige, Orange, Silver Gray, Forest Green, Jade Green, Violet, Yellow, Choc. Brown, White, Gray, Black.

Cart is enclosed with a white or beige vinyl staphcheck roll-up cover which closes securely with full length Velcro strips.

### #3000 with Roll-up Cover

1	2	3 or more
\$490.00 ea.	\$480.00 ea.	\$470.00 ea.

**Optional Top Cover Available at \$40.00.**

**Optional Vinyl Hood Available at \$55.00.**

**Model 3000**

Meets Joint Commission Requirements

See our website  
for a complete  
color chart

## MODEL 2000 UTILITY POLY SANITARY CART with Two Shelves

Lightweight, yet durable, easy rolling 30" length x 23" wide x 43" high, 11 cu. ft. capacity, four 5" swivel wheels, features a 3" deep recessed top tray, 2 shelves. Cart is dent-proof, washable, rust proof, available in many colors.

**Colors Available:** Apple Red, Royal Blue, Cadet Blue, Beige, Orange, Silver Gray, Forest Green, Jade Green, Violet, Yellow, Choc. Brown, White, Gray, Black.

Cart is enclosed with a white or beige vinyl staphcheck roll-up cover which closes securely with full length Velcro strips.

### #2000 with Roll-up Cover

1	2	3 or more
\$470.00 ea.	\$460.00 ea.	\$450.00 ea.

For quantities of more than six, please ask for our pricing.



**Model 2000**

Meets Joint Commission Requirements

### FIVE EASY WAYS TO ORDER:

1. **By Mail:** P.O. Box 190 • Syosset, NY 11791

2. **Toll-Free:** 1-800-288-3547

3. **By Fax:** 1-516-367-4714

4. **By email:** [LPCORP@aol.com](mailto:LPCORP@aol.com)

5. **Through our website:** [www.LatestProducts.net](http://www.LatestProducts.net)



SINCE 1972, DISTRIBUTORS OF SPECIALTY ITEMS FOR HOSPITALS, NURSING HOMES, INSTITUTIONS

# LATEST PRODUCTS CORP.

P.O. Box 190 • Syosset, New York 11791 • 1-800-288-3547 • Fax 1-516-367-4714 • email LPCORP@aol.com

## LAUNDRY, HOUSEKEEPING, GENERAL UTILITY TRUCKS

ALSO USED BY THOUSANDS OF COLLEGES AND UNIVERSITIES ON MOVE-IN/MOVE-OUT DAY

**NON-REPLACEABLE PERMANENTLY STITCHED LINER - Duck (Canvas) (D) or Vinyl (V)**

Rust-proof bottom with body steel rods concealed in liner.

Vinyl (V) Gray, Orange, Black, White, Burgundy, Yellow, Red, Green, Blue Available

Ideal for Correctional Facilities.  
No Rods Exposed.



#32 GM Heavy Duty Truck  
Comes with 3" casters

Bushels	Caster Size	Canvas Duck (D)	Vinyl (V) Gray, Orange, Black, White, Burgundy, Yellow, Red, Green, Blue Available
6	3"	\$135.00	\$131.00
8	3"	149.00	144.00
10	3"	155.00	150.00
12	3"	170.00	165.00
14	3"	192.00	186.00
16	3"	196.00	190.00
18	3"	209.00	203.00
20	3"	238.00	236.00
24	4"	277.00	274.00

Note: 5" casters available for an extra \$30.00 per cart.

Cover caps and cart liners which prolong the life of carts are featured on page 39.

Also available with lockable wood lid. See page 42, model #82.

More Vinyl Color Choices Now Available!

### #22 TRUCK WITH REMOVABLE REPLACEABLE LINER HEAVY DUTY DUCK (D) OR 18 OZ. VINYL NYLON LINER (V)

Plated Rust-Proof Frame and Bottom

Liners easily detached for washing and cleaning.

**NEW!**  
Push N' Pull Handle for utility trucks now available - see page 28.



Heavy Duty #22 Truck  
comes with 3" casters

#### CASTER ARRANGEMENTS AVAILABLE

A

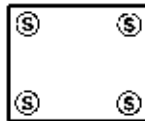

Corner mount (non-tilt)  
4 swivel casters

B

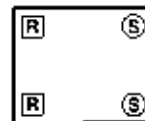

Corner mount (non-tilt)  
2 rigid and 2 swivel casters

C

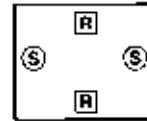

Diamond mount (tilt)  
2 rigid and 2 swivel casters

PLEASE SELECT CASTER ARRANGEMENT AS SHOWN ABOVE  
FOR LINERS PLEASE SPECIFY

D = Duck (Canvas)

V = Vinyl (Gray) or colors listed below

\*Vinyl (V) Gray, Orange, Black, White, Burgundy, Yellow, Red, Green, Blue Available

Bushels	Caster Size	Canvas Duck (D)	Vinyl (V) Gray, Orange, Black, White, Burgundy, Yellow, Red, Green, Blue Available
6	3"	\$139.00	\$136.00
8	3"	148.00	146.00
10	3"	156.00	152.00
12	3"	168.00	166.00
14	3"	179.00	177.00
16	3"	188.00	186.00
18	3"	194.00	192.00
20	3"	239.00	239.00

Note: 5" casters available for an extra \$30.00 per cart.

\*Light duty collapsible vinyl trucks are now available in all bushel sizes.

Ships knocked down by UPS for reduced freight costs. Recommended for very light loads only. Call or email for pricing for collapsible vinyl trucks.

#### ELEVATED SPRING PLATFORM

Helps Prevent Strains by having linen rise to waist level

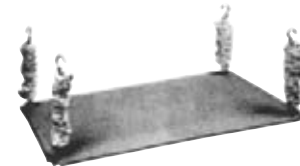

Bushel Capacity	# of Springs	#125 for Canvas	#125P for Molded
6	4	\$50.00	\$57.00
8	4	52.00	59.00
10	4	54.00	60.00
12	4	55.00	61.00
14	6	70.00	76.00
16	6	73.00	76.00
18	6	75.00	78.00
20	6	77.00	79.00
Springs only		14.00	15.00

See our website for a complete color chart !

# LAUNDRY TRUCKS AND LINERS

CHOOSE HEAVY DUTY DUCK OR 18 OZ. VINYL LAMINATED NYLON LINERS

Volume Bushels	Dimensions, Top ID ‡			Caster Size	Height Overall
	L (Top)	W (Top)	Depth		
6	30"	20"	20½"	3"	27"
8	34"	22"	23"	3"	29½"
10	36"	24"	25"	3"	31½"
12	36"	26"	27½"	3"	34"

‡ ID means Inside Dimensions.

Volume Bushels	Dimensions, Top ID ‡			Caster Size	Height Overall
	L (Top)	W (Top)	Depth		
14	40"	28"	27½"	3"	34"
16	40"	28"	30"	3"	36½"
18	42"	30"	30"	3"	36½"
20	48"	32"	30"	3"	36½"
24	54"	34"	30"	4"	37½"

## CASTER ARRANGEMENTS AVAILABLE (Please specify)

**A**



Corner mount (non-tilt) 4 swivel casters

**B**

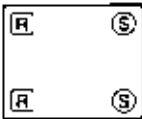

Corner mount (non-tilt) 2 rigid and 2 swivel casters  
*Our most popular*

**C**



Diamond mount (tilt) 2 rigid and 2 swivel casters

**D**

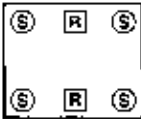

Full mount (tilt) 2 rigid and 4 swivel casters

# SANITARY NYLON LINERS AND COVERS

Designed for transport and storage of clean or soiled linen.  
Made of heavy duty 200-denier white nylon. Easily laundered.  
Custom sizes available. Please provide your measurements.



**No. 107 NY**

**No. 107 NY Basket Liner**  
Without flap.  
Elastic in top hem.



**No. 107 NYF**

**No. 107 NYF Basket Liner**  
With cover flap and elastic in top hem.



**No. 107 NYC**

**No. 107 NYC Nylon Cap or Cover**  
With elastic in top hem.  
Keeps basket contents clean.

Available in other materials and colors – please inquire.

	No. 107 NY	No. 107 NYF	No. 107 NYC
Bushel Capacity	Nylon Liner	Nylon Liner With Top Flap	Top Covers or Caps Only
4	\$23.75	\$28.25	\$15.50
5	23.75	28.25	15.50
6	23.75	28.25	15.50
8	25.95	30.75	16.50
10	27.50	32.50	17.00

	No. 107 NY	No. 107 NYF	No. 107 NYC
Bushel Capacity	Nylon Liner	Nylon Liner With Top Flap	Top Covers or Caps Only
12	\$29.25	\$34.55	\$17.75
14	30.50	36.25	19.75
16	31.75	37.75	19.75
18	33.00	39.25	20.80
20	37.25	44.25	22.25

Help extend the life of your laundry trucks.

# REPLACEMENT LINERS

will fit any standard oblong truck or basket



**Liner #30**

**More Vinyl Color Choices Now Available!**

## Minimum Order 2 Liners or \$75.00

Volume Bushels	Heavy-Duty Duck (Canvas)	Vinyl Nylon*
6	\$ 57.00	\$54.00
8	66.00	63.00
10	68.00	64.00
12	72.00	68.00
14	75.00	71.00
16	86.00	82.00
18	90.00	85.00
20	93.00	88.00
24	101.00	96.00

\*Standard color is gray; also available in Yellow, Red, Green, Blue, Orange, Black, White and Burgundy at same price.

Please provide us with your email for monthly specials and new product bulletins.





SINCE 1972, DISTRIBUTORS OF SPECIALTY ITEMS FOR HOSPITALS, NURSING HOMES, INSTITUTIONS

# LATEST PRODUCTS CORP.

P.O. Box 190 • Syosset, New York 11791 • 1-800-288-3547 • Fax 1-516-367-4714 • email LPCORP@aol.com

## GENERAL MULTIPURPOSE TRUCKS

Manufactured from molded polyethylene. 3" industrial grade casters are standard and are available in three arrangements. 5" industrial casters also available for an additional \$25 per cart. Trucks come equipped with a galvanized pan base which is moisture resistant, and is ideal for laundries. Spring platforms, push-n-pull handles, inner liners, and top cover caps available. For sizes 12, 14 and 16 bushel we offer a unique polyethylene hinged lid, see model #139 which is featured on page 15. Free stenciling also available.

### MODEL #22P INDUSTRIAL TRUCK WITH POLYETHYLENE LINER

Plated wire frame, rustproof bottom with replaceable polyethylene liner.



Model #	Capacity	Outside			Overall Height	Wall Thickness		
		Length	Width	Depth		.125 Standard	.175	.225
22P-6	6 bushel	34	24	21	27	\$228.00	\$235.00	\$237.00
22P-8	8 bushel	37	26	23½	29½	236.00	245.00	249.00
22P-10	10 bushel	40	28	25	31	248.00	261.00	269.00
22P-12	12 bushel	40	30	28	34	255.00	277.00	285.00
22P-14	14 bushel	43	32	28	34	276.00	289.00	299.00
22P-16	16 bushel	43	32	30	36	299.00	329.00	333.00
22P-18	18 bushel	46	34	30	36	323.00	339.00	349.00
22P-20	20 bushel	51	35½	30	36	347.00	379.00	387.00

Nylon cap cover #107NYC featured on previous page. Above carts come with 3" casters; 5" casters also available at \$30 additional per cart.

### MODEL #25 POLYETHYLENE LINER TO FIT ANY STANDARD BASKET OR LAUNDRY TRUCK



Model #	Capacity	Outside			Wall Thickness		
		Length	Width	Depth	.125 Standard	.175	.225
25 x 6 Liner	6 bushel	34	24	21	\$ 88.00	\$ 92.00	\$ 96.00
25 x 8 Liner	8 bushel	37	26	23½	89.00	97.00	102.00
25 x 10 Liner	10 bushel	40	28	25	97.00	110.00	115.00
25 x 12 Liner	12 bushel	40	30	28	103.00	113.00	128.00
25 x 14 Liner	14 bushel	43	32	28	110.00	125.00	136.00
25 x 16 Liner	16 bushel	43	32	30	135.00	149.00	160.00
25 x 18 Liner	18 bushel	46	34	30	138.00	156.00	164.00
25 x 20 Liner	20 bushel	51	35½	30	143.00	164.00	176.00

### MODEL #39 HEAVY DUTY TRUCK WITH GALVANIZED PAN BASE AND 3" CASTERS



Model #	Capacity	Outside			Overall Height	Wall Thickness	
		Length	Width	Depth		.225	.300
39-6	6 bushel	34	24	21	25	\$172.00	\$188.00
39-8	8 bushel	37	26	24	29	189.00	210.00
39-10	10 bushel	40	28	25	29	203.00	223.00
39-12	12 bushel	40	30	28	32	212.00	235.00
39-14	14 bushel	43	32	28	32	227.00	257.00
39-16	16 bushel	43	32	30	34	257.00	285.00
39-18	18 bushel	46	34	30	34	279.00	307.00
39-20	20 bushel	51	36	30	34	304.00	338.00

Nylon cap cover #107NYC featured on previous page. Above carts come with 3" casters; 5" casters also available at \$30 additional per cart.

#### Colors for #22P/25/39

Pink	Purple	Lime Green
Wine	Brite Lemon	Jade Green
Red	Brilliant Orange	Forest Green
Powder Blue	Beige	Honey Gold
Cadet Blue	Chocolate Brown	Metallic Silver (Gray)
Royal Blue	Black	

#### CASTER ARRANGEMENTS:

- A: Swivel at four corners
- B: Swivel at one end, fixed at other
- C: Diamond pattern, fixed on sides, swivel at ends (see previous page illustration)

Push N' Pull Handle for general multipurpose trucks featured on page 28

Our material handling experts are always available.  
Call 1-800-288-3547 with any questions you might have.

# LAUNDRY MULTIPURPOSE TRUCKS

## USED DAILY IN THOUSANDS OF FACILITIES

### EXTRACTOR TRUCK



Order as # 22N

**Extractor Truck  
Rustproof Bottom  
Replaceable Liner  
Optional Spring Platform  
available (see below)**

Liner is 18 oz.  
Vinyl-Laminated Nylon or Canvas.  
Please specify.

4" combination rigid and swivel  
casters are standard. Also  
available with 4" swivel casters.

### FLATWORK IRONER TRUCK



Order as # 19FWI

**Flatwork Ironer Truck  
Rustproof Bottom  
Replaceable Liner  
Comes with Spring Platform**

Liner is 18 oz.  
Vinyl-Laminated Nylon.

4" all swivel casters are standard,  
other arrangements available.  
Spring platform is included in price.

### SHEET FEED TRUCK



Order as # FO26

**Sheet Feed Truck  
Rustproof Bottom  
Replaceable Liner  
Comes with Spring Platform**

Liner is 18 oz.  
Vinyl-Laminated Nylon.

4" all swivel casters are standard.  
Truck and spring platform designed  
to reduce strain on operator by  
having linen rise to waist level.

22N Extractor Truck						19FWI Flatwork Truck						FO26 Truck				
Inside Dimensions (inches)						Inside Dimensions (inches)						Inside Dimensions (inches)				
Style No.	Bushels	Top			Overall Ht.	Style No.	Bushels	Top			Overall Ht.	Style No.	Bushels	Top		Overall Ht.
		L	W	H				L	W	H				L	W	
1	20	60	34	22	31	1	10	44	23	23	32	1	21	84	24	30
2	26	64	34	22	31	2	11	50	23	23	32	2	28	84	24	36
3	28	72	34	22	31	3	15	56	23	23	32					

### 22N Extractor Truck

Style No.	White Canvas	Vinyl Nylon	Replacement Liner Canvas	Replacement Liner Vinyl Nylon	Optional Spring Platform
1	\$270.00	\$265.00	\$ 98.00	\$95.00	\$125.00
2	282.00	277.00	100.00	97.00	125.00
3	320.00	315.00	102.00	99.00	125.00

### 19FWI Flatwork Ironer Truck

Style No.	Vinyl Nylon	Repl. Platform	Repl. Liner
1	\$349.00	\$ 84.00	\$70.00
2	365.00	86.00	72.00
3	412.00	115.00	75.00

### F026 Sheet Feed Truck

Style No.	Vinyl Nylon	Repl. Liner	Repl. Platform
1	\$388.00	\$130.00	\$75.00
2	390.00	130.00	75.00

Standard vinyl color is gray—other colors available

### FIVE EASY WAYS TO ORDER:

1. By Mail: P.O. Box 190 • Syosset, NY 11791
2. Toll-Free: 1-800-288-3547

3. By Fax: 1-516-367-4714
4. By email: LPCORP@aol.com

5. Through our website: www.LatestProducts.net



SINCE 1972, DISTRIBUTORS OF SPECIALTY ITEMS FOR HOSPITALS, NURSING HOMES, INSTITUTIONS

# LATEST PRODUCTS CORP.

P.O. Box 190 • Syosset, New York 11791 • 1-800-288-3547 • Fax 1-516-367-4714 • email LPCORP@aol.com

## LOCKABLE 1/2" PLYWOOD COVERED TRAVEL HAMPERS

Used by correctional institutions and where security is needed.  
Also used in schools, locker rooms, and by theatrical companies.

**More Vinyl Color Choices Now Available!**



Locking Rod (standard)—comes with hamper and required if padlock is to be used.



Snap n' Chain to keep lid down (\$7 per set)  
This item is not recommended for correctional institutions.



Corner Plates \$16.00 a set of 4.  
Corner plates go on corners of lid.

Bushel Capacity	Inside Dimensions Length x Width x Depth	Duck Canvas	Gray* Vinyl
		#82	#82S
6	30 x 20 x 20½	\$196.00	\$193.00
8	34 x 22 x 23	218.00	212.00
10	36 x 24 x 25	239.00	234.00
12	36 x 26 x 27½	255.00	250.00
14	40 x 28 x 27½	276.00	270.00
16	40 x 28 x 30	280.00	274.00
18	42 x 30 x 30	294.00	288.00
20	44 x 32 x 33	310.00	306.00
24	54 x 34 x 30	422.00	416.00

Lock not included.

\* Standard color is Gray for vinyl. Also available in Yellow, Red, Green, Blue, Orange, Black, White and Burgundy at same price.  
Comes with 4 swivel corner 3" casters.  
Add \$30 per cart for 5" casters.



Model #82

May also be used as a movable table.

Models #82 and 82S also available without lid – see page 38, Model #32GM.

- To secure the cover, these baskets come **standard with a locking rod** or optional "snap n' chain" set up.
- Replacement lock rods available for \$10.00.
- Replacement "snap n' chain" available for \$7.00 per set.

## ELEVATED TRUCKS Standard with 2" Stem Casters



#152 Permanent Liners  
Standard colors are white canvas or gray vinyl



#152-R (removable) shown.  
#152-RS (vinyl) also available.

Bushel Capacity	Inside Dimensions Length x Width x Depth	#152, 152R		
		Overall Height	White Canvas	#152-S, 152-RS Gray Vinyl
3	24 x 18 x 16	27"	\$79.00	\$78.00
4	30 x 18 x 16	30"	\$87.00	\$86.00
6	30 x 20 x 20½	30"	\$99.00	\$98.00

For 3" stem casters add \$10 per cart.  
Models with R have removable liners.  
Other vinyl colors available, please inquire.

## ELEVATED SPRING PLATFORM Helps prevent strains by raising contents to operator waist level



Bushel Capacity	# of Springs	#125 for Canvas Trucks	#125P for Molded Trucks
6	4	\$50.00	\$57.00
8	4	52.00	59.00
10	4	54.00	60.00
12	4	55.00	61.00
14	6	70.00	76.00
16	6	73.00	76.00
18	6	75.00	78.00
20	6	77.00	79.00
Springs only		14.00	15.00

## POLY ELEVATED TRUCKS *Level and Slant Style frames\** GREAT FOR DAMP LINEN STORAGE

2" Standard rubber swivel casters.



No. 652 with .100 thick liner

Bushel Size	Inside Dimensions Length x Width x Depth x Height	#652	#652-B	#652-B	#616 White
		White Only .100 thick	White Only .150 thick	Colors .150 thick	Top Cover Only .125 thick
2	22 x 14 x 14 x 27	\$ 84.00	\$ 91.00	\$ 95.00	—
3	24 x 18 x 16 x 27	97.00	103.00	105.00	\$33.00
4	30 x 18 x 16 x 30	105.00	110.00	113.00	42.00
6	30 x 20 x 20½ x 30	113.00	130.00	135.00	—

\*Slant options are available on the four and six bushel frames only.  
To add a drain fitting and hose on any "B" thickness basket, add \$50.00 to above prices.  
3" diameter rubber swivel casters extra at \$10.00 per basket. 3" casters add 1" to overall height.  
Standard polyliner color is white.



Level style frame Standard

**TERMS: 2% ten days, net 30, F.O.B. Factory. We prepay shipping and add to invoice.**

# ALUMINUM LINEN SERVICE TRUCKS WITH DOORS OR FABRIC CLOSURE

Our aluminum carts are durable, yet lightweight. Ideal for use in hospitals, nursing homes, hospices, clinics, and other facilities where ample storage space, cleanliness and economy are important.

Sturdy, one-piece bodies—of airplane riveted 14-gauge aluminum sheet, with continuous door hinges. A continuous non-marking rubber bumper at the cart bottom is standard on all four sides of all carts. Double hinged doors open 270 degrees as shown below to provide easy access.

Flap closures are made of vinyl-coated fabric, highly resistant to abrasion and fire, with Velcro closure. Durable clear lacquer finish for long-lasting beauty and easy cleaning. Handles recessed at both ends to protect walls.

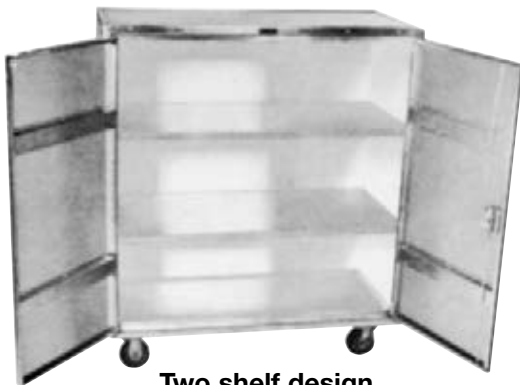

Two shelf design



Compartment design

## FOR 25 TO 30 BED CAPACITY:

### Two shelf design (shelves equally spaced)

LCD 125 with doors	\$1845.00
LCD 125L with doors and lock	1875.00
LCF 125 with vinyl-clad fabric closure	1595.00
<b>Weight: 210 lbs.</b>	

### Compartment design

LCD 116 with doors	\$1880.00
LCD 116L with doors and lock	1895.00
LCF 116 with vinyl-clad fabric closure	1620.00
<b>Weight: 200 lbs.</b>	

## FOR 30 TO 40 BED CAPACITY:

### Two shelf design (shelves equally spaced)

LCD 128 with doors	\$1950.00
LCD 128L with doors and lock	1975.00
LCF 128 with vinyl-clad fabric closure	1695.00
<b>Weight: 230 lbs.</b>	

### Compartment design

LCD 121 with doors	\$1875.00
LCD 121L with doors and lock	1895.00
LCF 121 with vinyl-clad fabric closure	1655.00
<b>Weight: 220 lbs.</b>	

### OPTIONS:

<b>Top Rail</b>	\$175.00
<b>Adjustable Shelves:</b>	
For two shelf models	110.00
For compartment models	395.00
<b>Bifold Doors</b>	185.00

		Inside Dimensions (inches) (Body less Casters; View facing Truck)					
		LCD116, LCF116			LCD121, LCF121		
		H	L	W	H	L	W
Left Section	Top Compartment	9 1/4"	10 1/2"	20 1/2"	10 1/4"	18 1/2"	27 1/2"
	Center Compartment	17 1/4"	10 1/2"	20 1/2"	17 1/4"	18 1/2"	27 1/2"
	Bottom Compartment	18 3/4"	10 1/2"	20 1/2"	17 1/2"	18 1/2"	27 1/2"
Middle Section	Top Compartment	19 1/4"	20 1/4"	20 1/2"	20 3/4"	11 1/4"	27 1/2"
	Bottom Compartment	26 3/4"	20 1/4"	20 1/2"	25 1/4"	11 1/4"	27 1/2"
Right Section	Top Compartment	12 3/4"	10 1/2"	20 1/2"	10 1/4"	18 1/2"	27 1/2"
	Center Compartment	11 1/4"	10 1/2"	20 1/2"	17 1/4"	18 1/2"	27 1/2"
	Bottom Compartment	21 1/4"	10 1/2"	20 1/2"	17 1/2"	18 1/2"	27 1/2"
Outside		48"	48"	24"	48"	55"	31"

Dimensions shown are for cabinets only.

Outside dimensions include the rubber bumper which is 2" wide.

6" rubber casters, 2 swivel/2 rigid.

Casters add 7 1/2" to overall height.

		Inside Dimensions (inches) (Body less Casters; View facing Truck)					
		LCD125, LCF125			LCD128, LCF128		
		H	L	W	H	L	W
Inside (Three equal compartments)		15"	41 3/8"	20 1/2"	15"	48 3/8"	27 1/2"
Outside		48"	48"	24"	48"	55"	31"

*We also offer a special aluminum truck (Model CS101) designed for central supply.*

Quantity discounts available.

Call 1-800-288-3547 for a prompt, money-saving quotation.



SINCE 1972, DISTRIBUTORS OF SPECIALTY ITEMS FOR HOSPITALS, NURSING HOMES, INSTITUTIONS

# LATEST PRODUCTS CORP.

P.O. Box 190 • Syosset, New York 11791 • 1-800-288-3547 • Fax 1-516-367-4714 • email LPCORP@aol.com

## ENCLOSED LINEN SUPPLY CARTS

**EFFICIENT HANDLING AND DISTRIBUTION:** Enclosed linen carts provide efficient contamination-free handling and distribution of linens or medical and patient supplies.

**HEAVY-DUTY:** Carts are constructed of high-strength aluminum for heavy-duty use. Silver anodized finish is clean and attractive.

**THREE SIZES:** Supply carts are available in small, medium and large sizes.

**CAPACITY:** On a 24-hour exchange system, these carts will furnish linen as follows:

- Small Cart — 20 beds
- Medium Cart — 20-30 beds
- Large Cart — 30-40 beds

They will accommodate other supplies in a similar ratio.

**ADJUSTABLE ALUMINUM SHELVES:** All models have two adjustable aluminum shelves so carts can be adapted to specific needs. On medium and large size carts, shelves are reinforced with angle braces running their full length. **Additional shelves are available for all models.**

**CHOICE OF DOOR OR FLAP:** All models feature an aluminum back and sides. To protect contents from airborne contaminants, small and medium carts are available with either lockable aluminum doors or a polyester-vinyl flap. Large carts come with polyester-vinyl flap only.

**CASTERS:** Models T523A and T524A (small carts) have two 5" polyurethane tread swivel casters and two 5" polyurethane tread rigid casters. All other models feature four 8" extra heavy-duty non-marking resilient rubber casters with swivel locks on two diagonal corners.

**Discounts offered for larger quantities. Please inquire**



#T524A  
#T544A



#T523A  
#T543A  
#T563A

Buy 2 or more and take an additional 5% off.

Item Number		Height (in.)		Depth (in.)		Length (in.)	
With Flap	With Door	Inside	Outside	Inside	Outside	Inside	Outside
T523A	T524A	30 <sup>1</sup> / <sub>16</sub>	42 <sup>13</sup> / <sub>16</sub>	22	24 <sup>1</sup> / <sub>2</sub>	32 <sup>1</sup> / <sub>2</sub>	39
T543A	T544A	45 <sup>5</sup> / <sub>16</sub>	61 <sup>1</sup> / <sub>16</sub>	22	24 <sup>1</sup> / <sub>2</sub>	47	53 <sup>1</sup> / <sub>2</sub>
T563A		51 <sup>13</sup> / <sub>16</sub>	66 <sup>1</sup> / <sub>2</sub>	22	24 <sup>5</sup> / <sub>8</sub>	58	64 <sup>1</sup> / <sub>2</sub>

## STARSSYS™ ENCLOSED LINEN EXCHANGE CART

Polymer doors, sides and backs won't rust, dent, chip or peel. Enclosed environment provides efficient contamination-free handling and distribution of linens. Cart consists of four stationary shelves, non-locking 270 degree swing doors, 5" polyurethane swivel casters (two with brakes).

Shelf Width/Length (inches)	Approx. Height (inches)	Pkd. Wt. (lbs.)	Item No.	Price Each
22 x 40	76	312	SXD76CM3	\$2,250

Outside cart measurements: 25" x 43" x 76"

### Additional Shelves

Fits	Cat. No.	Price Each
Stationary Shelf	SXDWQ	\$ 75 each
Full Extension Pullout	SXDWAR	\$110 each



SXD76CM3 Starssys Enclosed Linen Exchange Cart  
Comes standard with 4 shelves.

### FIVE EASY WAYS TO ORDER:

1. **By Mail:** P.O. Box 190 • Syosset, NY 11791

2. **Toll-Free:** 1-800-288-3547

3. **By Fax:** 1-516-367-4714

4. **By email:** LPCORP@aol.com

5. **Through our website:** www.LatestProducts.net



**5 Tier Models also available. Please inquire.**

**Additional Stem Caster Carts on page 52. Please also see our new line of Suture Carts on page 90.**

# STEM CASTER, DOLLY CARTS AND SPECIALTY CARTS

## Chrome Stem Caster Carts

Four adjustable wire shelves, 5" Casters. All swivel or swivel with brakes. Open-wire shelf design minimizes dust and increases air circulation and visibility. With Chrome Shelves and Chrome-Plated Posts – 63" Posts — Overall Height 69" Rubber casters can support 600 pounds – polyurethane casters can support 900 pounds and offer easier rolling. Chrome push handle – add \$25. Chrome extended handle – add \$35.

Shelf Width/Length (in.)	Approx. Pkd. Wt. (lbs.)	Four Swivel		Two Swivel Two Brake		Four Swivel Polyurethane		Two Swivel Two Brake Polyurethane	
		Resilient Rubber Casters	Price Each	Resilient Rubber Casters	Price Each	Polyurethane Casters	Price Each	Polyurethane Casters	Price Each
18 x 36	60	A336AC	\$295.00	A336BC	\$305.00	A336DC	\$335.00	A336EC	\$345.00
18 x 48	72	A356AC	325.00	A356BC	335.00	A356DC	370.00	A356EC	380.00
18 x 60	88	A366AC	360.00	A366BC	370.00	A366DC	400.00	A366EC	410.00
21 x 36	69	A436AC	325.00	A436BC	335.00	A436DC	365.00	A436EC	375.00
21 x 48	81	A456AC	355.00	A456BC	365.00	A456DC	395.00	A456EC	405.00
21 x 60	98	A466AC	385.00	A466BC	395.00	A466DC	430.00	A466EC	440.00
24 x 36	76	A536AC	335.00	A536BC	345.00	A536DC	380.00	A536EC	390.00
24 x 48	92	A556AC	370.00	A556BC	380.00	A556DC	415.00	A556EC	425.00
24 x 60	112	A566AC	415.00	A566BC	425.00	A566DC	455.00	A566EC	465.00

Shipped knocked down for easy assembly. Enclosures for sides and back available at \$230/cart. Bottom solid shelf available either in stainless steel or galvanized at additional cost. We feature a large selection of cart covers; see pages 10 and 11.

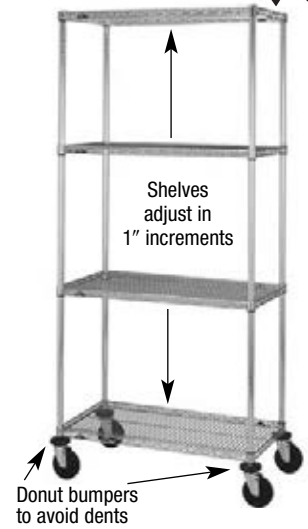

Wire Stem Caster Cart with adjustable shelves. Enclosure panels available.

## Enclosed Chrome Slanted Shelf Trucks and Carts

Shelves slope backwards 2" to keep items from falling during transport. Standard-duty carts have four poly stem casters. Heavy-duty trucks are dolly mounted and have brakes.

Width/Length (in.)	Height* (in.)	Number of Shelves	Casters	Description	Approx. Pkd. Wt. (lbs.)	Cat. No.	Price Each
24 x 36	62	3	6" 2 swivel/2 locking	Heavy-Duty	140	AST35MC	\$1095.00
24 x 48	62	3	6" 2 swivel/2 locking	Heavy-Duty	162	AST55MC	1135.00
24 x 60	62	3	6" 2 swivel/2 locking	Heavy-Duty	187	AST65MC	1195.00
24 x 36	59	3	5"-Poly Casters	Standard-Duty	105	AST35DC	590.00
24 x 48	59	3	5"-Poly Casters	Standard-Duty	125	AST55DC	660.00
24 x 60	59	3	5"-Poly Casters	Standard-Duty	150	AST65DC	705.00

\*Casters add approximately 6" to overall height.



Standard-Duty Slanted Shelf Cart with adjustable shelves. Bottom shelf only remains level.

### Additional Slanted Shelves

Width/Length (in.)	Approx. Pkd. Wt. (lbs.)	Cat. No. Chrome	Price Each
24 x 36	13	SLT2436NC	\$75.00
24 x 48	17	SLT2448NC	85.00
24 x 60	22	SLT2460NC	90.00

**See pages 61-63 for accessories**

## Chrome Wire Dolly Trucks

With Chrome Shelves and wraparound bumper. 63" Plated Posts and Aluminum Dolly. 69" Overall height.

Shelf Width/Length (in.)	Approx. Pkd. Wt. (lbs.)	Catalog Number with Casters			
		5" Casters Neoprene 2 swivel/ 2 brake	5" Casters Polyurethane 2 swivel/ 2 brake	6" Casters Polyurethane 2 swivel/ 2 lock/2 brake	8" Casters Polyurethane 2 swivel/ 2 lock/2 brake
18 x 36	78	N336JC	\$465.00		
18 x 48	92	N356JC	515.00	N356LC	\$555.00
18 x 60	110	N366JC	560.00	N366LC	605.00
21 x 36	88	N436JC	510.00		
21 x 48	104	N456JC	550.00	N456LC	595.00
21 x 60	125	N466JC	600.00	N466LC	645.00
24 x 36	96	N536JC	520.00	N536LC	565.00
24 x 48	118	N556JC	570.00	N556LC	615.00
24 x 60	142	N566JC	630.00	N566LC	670.00
				N536MC*	\$835.00
				N556MC*	880.00
				N566MC*	940.00
				N556PC*	\$885.00
				N566PC*	935.00

Dollies add 3/8" to the length of the unit and 3/8" to the width of the unit. Polyurethane (poly) supports a greater weight than Neoprene casters.

\*For 6" and 8" models, brake lock/swivel lock controls are located on dolly for easy use!



Dolly Truck Enclosure panels available.

Custom configurations and sizes available on most of the above carts.



SINCE 1972, DISTRIBUTORS OF SPECIALTY ITEMS FOR HOSPITALS, NURSING HOMES, INSTITUTIONS

# LATEST PRODUCTS CORP.

P.O. Box 190 • Syosset, New York 11791 • 1-800-288-3547 • Fax 1-516-367-4714 • email LPCORP@aol.com

## SPECIALTY CARTS AND STORAGE UNITS

### Chrome Patient Item Cart

Specially-designed cart helps keep individual patients' clothing separated during transport from the laundry to individual rooms. Five-inch swivel casters, two with brakes, make the cart glide easily over all floor surfaces. Cart comes equipped with 3 shelves.

Width/Length (in.)	Style	Coat Hanger Tube Length (in.)	Shelf Length (in.)	No. of Dividers	No. of Label Holders	No. of Enclosure Rods	Cat. No. Chrome	Price Each
24 x 48	Standard	24	24	8	12	12	PIC55BC	\$725.00
24 x 60	Standard	24	36	12	16	12	PIC56BC	845.00
24 x 48	Heavy-Duty	24	24	8	12	12	PIC55JC*	860.00
24 x 60	Heavy-Duty	24	36	12	16	12	PIC56JC*	985.00

All units are 68" high.

\*Includes wraparound bumper.



PIC56JC

### Accessories

Description	Model	Price Each
8" High Dividers	DD24C	\$19.00
Rod (Includes 4 fastening tabs)	R61C	7.00
Label Holders	9990P	3.00
24" x 24" Chrome Shelf (Additional Shelf for PIC55BC and PIC55JC)	A2424NC	50.00
24" x 36" Chrome Shelf (Additional Shelf for PIC56BC and PIC56JC)	A2436NC	55.00

### MetroMax I.V. Transport/Storage System

The Perfect Solution For: Exchange System, Bulk Storage in Central Supply, Pharmacy Admixture, I.C.U. and E.R. Storage. Baskets have semi-open front for easy access. Dividers adjust horizontally within the basket to accept various sizes of I.V. bags. Continuous label holders identify basket contents.

### Dimensions

Model No.	Description	Width (in.)	Length (in.)	Height (in.)	Total Baskets Per Cart	Casters	Price Each
MXIV1	Open Cart	24	24	60	4	*	\$ 965.00
MXIV2	Open Cart with Top Shelf	24	24	69	4	*	1,075.00
MXIV4	Open Cart	24	42	60	8	†	1,650.00
MXIV5	Open Cart with Top Shelf	24	42	69	8	†	1,765.00
MXIV6	Open Cart	24	60	60	12	†	2,135.00
MXIV7	Open Cart with Top Shelf	24	60	69	12	†	2,295.00

**NOTE: Each basket sold with cart includes two dividers.**

\*Four 5" (127mm) poly casters; two swivel, two with brake.

†5" (127mm) poly casters on an aluminum dolly frame; two swivel, one swivel with brake, and one rigid.



MXIV1



IVB1 (shown with optional Divider)

### Accessories

Description	Size (in.)	Cat. No.	Price Each
Basket* with Label Holder	18½ x 24½ x 10	IVB1	80.00
Divider	9	IVBD	18.00

\*Basket weight capacity is 35 lbs.

### Inhalation Therapy Cart

Holds size "D" and "E" cylinders.

Approx. Height/Width/Length (in.)	Pkd. Wt. (lbs.)	Cat. No.	Price Each
39 x 20½ x 26	40½	ITC12C	\$360.00



ITC12C Inhalation Therapy Cart

### Soiled Linen Carts – which open from top or side

Constructed of 14-gauge, high-strength aluminum. Upper side door drops down for easy loading; bottom door swings up for unloading. Sealed interior seams and smooth obstruction-free interior simplify cleaning. Silver anodized aluminum finish won't stain or discolor linen. Unit comes equipped with 5" casters that adhere to base.

Overall Width/Length/Height (in.)	Inside Width/Length/Height (in.)	Finish	Approx. Pkd. Wt. (lbs.)	Cat. No.	Price Each
32¼ x 56 x 46¾	30 x 50 x 38¼	Anodized	108	T68A	1,900.00

### Caster Upgrades

Order either two C8AIR and two C8AIRR casters, or two C8DA and two C8DRA casters.

Description	Model	Price per Wheel
8" Extra Heavy-Duty Pneumatic-Tired Caster, swivel	C8AIR	100.00
8" Extra Heavy-Duty Rigid Pneumatic-Tired Caster	C8AIRR	100.00
8" Heavy-Duty Rubber-Tired Caster, swivel	C8DA	65.00
8" Heavy-Duty Rigid Rubber-Tired Caster	C8DRA	65.00

Wheel Brake not available on Pneumatic Casters. 2 swivel/2 rigid casters needed per cart.



T68A Soiled Linen Cart

Opens from top and side and comes with a recessed handle.

Latest Products carries a complete line of suture carts, sterile wrap rack carts, catheter procedure carts, crash carts, and lab carts. Please call or email us for more details.

# CHROME SECURITY STORAGE CARTS AND UNITS

Contents are visible and carts lock to protect against pilferage.

- Adjustable chrome wire shelves sold separately, see below.
- Double door – each door opens 270 degrees and can be secured at sides.
- Shipped knocked down to save on freight.
- Lock up valuables, syringes, medication, drugs, and supplies.
- Stainless steel models also available.

## quikSLOT Stationary Security Unit (no casters)

Width (inches)	Length (inches)	Height (inches)	Fits Shelf (inches)	Approx. Pkd. Wt. (lbs.)	Cat. No. Chrome	Price Each
21½	38½	66⅙	18 x 36	138	SEC33CQ	\$675.00
21½	50½	66⅙	18 x 48	157	SEC35CQ	835.00
27¼	38½	66⅙	24 x 36	154	SEC53CQ	695.00
27¼	50½	66⅙	24 x 48	174	SEC55CQ	860.00
27¼	62½	66⅙	24 x 60	195	SEC56CQ	935.00

Buy 2 or more and take an additional 5% off.

## quikSLOT Mobile Security Cart

Standard-Duty Stem Caster Models: feature 5" swivel casters. Please note model numbers for specific caster types.

Caster Type	Width (inches)	Length (inches)	Height (inches)	Fits Shelf (inches)	Approx. Pkd. Wt. (lbs.)	Cat. No. Chrome	Price Each
(2) 5MP/(2) 5MPB	21½	40¾	68½	18 x 36	146	SEC33ECQ	\$ 795.00
(2) 5MP/(2) 5MPB	21½	52¾	68½	18 x 48	165	SEC35ECQ	970.00
(4) 5MP	27¼	40¾	68½	24 x 36	162	SEC53DCQ	815.00
(4) 5MP	27¼	52¾	68½	24 x 48	182	SEC55DCQ	980.00
(4) 5MP	27¼	65	68½	24 x 60	203	SEC56DCQ	1055.00
(2) 5MP/(2) 5MPB	27¼	40¾	68½	24 x 36	162	SEC53ECQ	820.00
(2) 5MP/(2) 5MPB	27¼	52¾	68½	24 x 48	182	SEC55ECQ	995.00
(2) 5MP/(2) 5MPB	27¼	65	68½	24 x 60	203	SEC56ECQ	1060.00

Casters: 5MP (swivel) and 5MPB (with locking brake) feature a polyurethane tread.

Note: Large casters can create a tipping hazard. On 18" security units, do not use casters larger than 5" in diameter.

Buy 2 or more and take an additional 5% off.

**Heavy-Duty Models:** feature aluminum dollies with wraparound bumpers and 5" diameter casters, two with brakes.

Caster Type	Width (inches)	Length (inches)	Height (inches)	Fits Shelf (inches)	Approx. Pkd. Wt. (lbs.)	Cat. No. Chrome	Price Each
(2) 5BP/(2) 5BPB	28⅞	38½	68½	24 x 36	187	SEC53LCQ	\$1025.00
(2) 5BP/(2) 5BPB	28⅞	50½	68½	24 x 48	210	SEC55LCQ	1,195.00
(2) 5BP/(2) 5BPB	28⅞	63¾	68½	24 x 60	235	SEC56LCQ	1,275.00

## Intermediate Shelves for Security Units and Security Carts

Width (inches)	Length (inches)	Approx. Pkd. Wt. (lbs.)	Cat. No. Chrome	Price Each
18	36	8½	1836QBR	\$40.00
18	48	11¼	1848QBR	48.00
24	36	13	2436QBR	50.00
24	48	16	2448QBR	57.00
24	60	21	2460QBR	68.00

Stainless steel models available, please inquire.  
Shelving accessories available, see pages 61-63.  
Cart covers available for all models, see pages 10-11.



SEC53DCQ shown with Intermediate Shelves (optional)



Clips snap easily into slots along post length to support shelves.



**quikSLOT Locking Clip**  
Recommended for mobile applications. (Package of 4)  
Cat. No. 9985QSL  
Price \$10/pkg.



SINCE 1972, DISTRIBUTORS OF SPECIALTY ITEMS FOR HOSPITALS, NURSING HOMES, INSTITUTIONS

# LATEST PRODUCTS CORP.

P.O. Box 190 • Syosset, New York 11791 • 1-800-288-3547 • Fax 1-516-367-4714 • email LPCORP@aol.com

**Buy 2 or more  
and take an  
additional  
5% off.**

## CHROME AND STAINLESS STEEL STANDARD DUTY UTILITY CARTS 3-Shelf Models

With adjustable shelves and 4" casters for  
18" width and 5" casters for larger sizes, with overall 39" height.

### MW Standard-Duty Utility Carts

#### MW200 Series — 3 Solid Shelves

Width/Length (in.)	Approx. Pkd. Wt. (lbs.)	Shelf Material	Handles	Cat. No.	Price Each
18 x 24	48	Stainless Steel	Stainless Steel	<b>MW203</b>	\$505.00
18 x 30	53	Stainless Steel	Stainless Steel	<b>MW204</b>	555.00
18 x 36	59	Stainless Steel	Stainless Steel	<b>MW205</b>	585.00
21 x 36	66	Stainless Steel	Stainless Steel	<b>MW206</b>	635.00
24 x 36	74	Stainless Steel	Stainless Steel	<b>MW208</b>	675.00



#### MW300 Series — 2 Solid, 1 Wire Shelf

Wire shelf can go on top, bottom or middle.

Width/Length (in.)	Approx. Pkd. Wt. (lbs.)	Shelf Material	Handles	Cat. No.	Price Each
18 x 24	46	Stainless Steel, Chrome	Chrome	<b>MW301</b>	\$355.00
18 x 30	52	Stainless Steel, Chrome	Chrome	<b>MW302</b>	385.00
18 x 36	57	Stainless Steel, Chrome	Chrome	<b>MW303</b>	405.00
21 x 36	62	Stainless Steel, Chrome	Chrome	<b>MW304</b>	440.00
24 x 36	69	Stainless Steel, Chrome	Chrome	<b>MW306</b>	465.00



#### MW400 Series — 1 Solid, 2 Wire Shelves

Solid shelf can go on top, bottom or middle.

Width/Length (in.)	Approx. Pkd. Wt. (lbs.)	Shelf Material	Handles	Cat. No.	Price Each
18 x 24	43	Stainless Steel, Chrome	Chrome	<b>MW401</b>	\$275.00
18 x 30	47	Stainless Steel, Chrome	Chrome	<b>MW402</b>	295.00
18 x 36	52	Stainless Steel, Chrome	Chrome	<b>MW403</b>	305.00
21 x 36	59	Stainless Steel, Chrome	Chrome	<b>MW404</b>	335.00
24 x 36	65	Stainless Steel, Chrome	Chrome	<b>MW406</b>	355.00



#### MW700 Series — 3 Wire Shelves

Shelves and handles manufactured from materials shown below.

Width/Length (in.)	Approx. Pkd. Wt. (lbs.)	Shelf Material	Handles	Cat. No.	Price Each
18 x 24	39	Chrome	Chrome	<b>MW701</b>	\$205.00
18 x 24	38	Stainless Steel	Stainless Steel	<b>MW702</b>	475.00
18 x 30	43	Chrome	Chrome	<b>MW703</b>	220.00
18 x 30	42	Stainless Steel	Stainless Steel	<b>MW704</b>	525.00
18 x 36	47	Chrome	Chrome	<b>MW705</b>	225.00
18 x 36	45	Stainless Steel	Stainless Steel	<b>MW706</b>	555.00
21 x 36	50	Chrome	Chrome	<b>MW707</b>	245.00
21 x 36	50	Stainless Steel	Stainless Steel	<b>MW708</b>	625.00
24 x 36	60	Chrome	Chrome	<b>MW711</b>	255.00
24 x 36	57	Stainless Steel	Stainless Steel	<b>MW712</b>	665.00

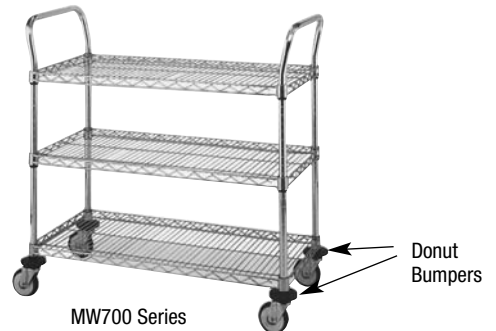

**Cart Covers available for all MW Series with handle cut-outs.**

**Please Note: As the cost of raw materials and fuel escalate, all prices are subject to change without notice.**



# CHROME AND STAINLESS STEEL STANDARD DUTY UTILITY CARTS 2-Shelf Models

Buy 2 or more  
and take an  
additional  
5% off.

## MW Standard-Duty Utility Carts

- A durable, dependable transport solution that's easy to maneuver.
- Highly rigid construction lets you easily adjust shelves at 1" increments.
- Each cart consists of 2 handles, indicated number of shelves as shown, and casters. 18" wide carts have 4" light-duty casters and are 38" overall height. The 21" and 24" wide carts have 5" light-duty casters providing 375 lbs. of load capacity and are 39" overall height.
- Shipped knocked-down.

### MW100 Series — 2 Solid Shelves

Width/Length (in.)	Approx. Pkd. Wt. (lbs.)	Shelf Material	Handles	Cat. No.	Price Each
18 x 24	40	Stainless Steel	Stainless Steel	<b>MW103</b>	\$398.00
18 x 30	45	Stainless Steel	Stainless Steel	<b>MW104</b>	430.00
18 x 36	48	Stainless Steel	Stainless Steel	<b>MW105</b>	450.00
21 x 36	54	Stainless Steel	Stainless Steel	<b>MW106</b>	485.00
24 x 36	60	Stainless Steel	Stainless Steel	<b>MW108</b>	515.00



MW100 Series

### MW500 Series — 1 Solid, 1 Wire Shelf Solid Shelf can go on top or bottom

Width/Length (in.)	Approx. Pkd. Wt. (lbs.)	Shelf Material	Handles	Cat. No.	Price Each
18 x 24	38	Stainless Steel, Chrome	Chrome	<b>MW501</b>	\$255.00
18 x 30	40	Stainless Steel, Chrome	Chrome	<b>MW502</b>	275.00
18 x 36	46	Stainless Steel, Chrome	Chrome	<b>MW503</b>	285.00
21 x 36	51	Stainless Steel, Chrome	Chrome	<b>MW504</b>	310.00
24 x 36	55	Stainless Steel, Chrome	Chrome	<b>MW506</b>	320.00



MW500 Series

### MW600 Series — 2 Wire Shelves

Width/Length (in.)	Approx. Pkd. Wt. (lbs.)	Shelf Material	Handles	Cat. No.	Price Each
18 x 24	34	Chrome	Chrome	<b>MW601</b>	\$180.00
18 x 24	34	Stainless Steel	Stainless Steel	<b>MW602</b>	375.00
18 x 30	37	Chrome	Chrome	<b>MW603</b>	185.00
18 x 30	37	Stainless Steel	Stainless Steel	<b>MW604</b>	405.00
18 x 36	40	Chrome	Chrome	<b>MW605</b>	190.00
18 x 36	39	Stainless Steel	Stainless Steel	<b>MW606</b>	425.00
21 x 36	44	Chrome	Chrome	<b>MW607</b>	205.00
21 x 36	44	Stainless Steel	Stainless Steel	<b>MW608</b>	480.00
24 x 36	47	Chrome	Chrome	<b>MW611</b>	215.00
24 x 36	46	Stainless Steel	Stainless Steel	<b>MW612</b>	505.00



MW600 Series

Cart covers with handle cut-outs available.

Do we have your email address? Please let us know so we can offer you our monthly email specials.





SINCE 1972, DISTRIBUTORS OF SPECIALTY ITEMS FOR HOSPITALS, NURSING HOMES, INSTITUTIONS

# LATEST PRODUCTS CORP.

P.O. Box 190 • Syosset, New York 11791 • 1-800-288-3547 • Fax 1-516-367-4714 • email LPCORP@aol.com

## PVC CERTIFIED NURSE AIDE CART



**C-CNAC31**

**\$270.00**

The cart nurse aides have always wanted. Their very own low cost supply cart for transporting anything they need for providing patient care. Beneath the top shelf writing surface, three roomy drawers and a bottom shelf afford ample space for all supplies.

- 44" H x 26" L x 16" W
- 3 drawers 7" H x 19" L x 14" W
- Weight: 37 lbs.
- Constructed of high quality pipe and polypropylene.
- 3 large supply drawers.
- 26" x 16" bottom storage shelf.
- Top shelf writing surface.
- 3" easy-roll casters, 2 locking.

## PVC NURSING SUPPLY CART



**C-NSC24**

**\$390.00**

Mobile storage system for nursing supplies. A low cost, versatile cart to transport nursing supplies to all areas of the facility.

- 44" H x 30" L x 17½" W
- 4 drawers 7" H x 10½" L x 13" W
- 4 drawers 3" H x 10½" L x 13" W
- Weight: 50 lbs.
- 8 storage drawers in two sizes with top shelf writing surface.
- 30" x 18" bottom shelf for additional storage.
- Cart is lockable with swing-out gate, padlock not included.
- 3" easy-roll casters, 2 locking.

**TERMS: 2% ten days, net 30, F.O.B. Factory. We prepay shipping and add to invoice.**

# PVC CLEAN LINEN CARTS

Attractive, Lightweight and Durable!

PVC Carts can be manufactured to your specific measurements. Contact us for details.

See our website for many more PVC Clean Linen Carts, PVC Garment Racks and PVC Pillow Carts.



**C-LC36-3**                      **\$425.00**  
48" overall H x 40" L x 20" W (45 lbs.)  
36" x 20" removable shelves with 12" spacing



**C-MPC375**                      **\$410.00**  
52" overall H x 31" L x 20" W (36 lbs.)  
26" x 20" removable shelves with 14.5" spacing



**C-LC46-3**                      **\$530.00**  
64" overall H x 48½" L x 20" W (55 lbs.)  
46" x 20" removable shelves with 16" spacing

## **OUR CLEAN LINEN CARTS FEATURE:**

- New designed ergonomic push bars move easily throughout your facility—even when full.
- Cover opens on both sides for easy loading and unloading.
- Removable shelves and cover are simple to clean.
- 5" casters with 2 locking standard. Full locking 5" and 6" casters available.
- Covers are available in colors listed below.
- Various other sizes and customizable dimensions available. Call for details.

Our PVC clean linen carts come complete with a cart cover that opens from the front and back (double flap) which can be wiped clean. PVC is cost effective, retains its shine, will not stain and will not fade.

Choose from the following materials and colors:

Woven Mesh Material: Navy Blue, Royal Blue, Plum, Wineberry, Maroon, Silver, Mint Green, Forest Green, Teal, White, Linen.  
Staphcheck Anti-Bacterial Material: Mint Green, Light Blue, Pink, White, or Teal/Blue Brushstroke.

Please Note: As the cost of raw materials and fuel escalate, all prices are subject to change without notice.



SINCE 1972, DISTRIBUTORS OF SPECIALTY ITEMS FOR HOSPITALS, NURSING HOMES, INSTITUTIONS

# LATEST PRODUCTS CORP.

P.O. Box 190 • Syosset, New York 11791 • 1-800-288-3547 • Fax 1-516-367-4714 • email LPCORP@aol.com

## MICROBAN PROTECTION STEM CASTER CARTS Corrosion Proof Polymer Construction with Stainless Steel Corners

- With built-in Microban® anti-microbial protection which inhibits the growth of bacteria, mold, mildew, and fungi that cause odors, stains and product degradation.
- Shelves adjust at 1/2" increments.
- Mats lift off for easy cleaning.
- Reinforced polymers offer incredible strength—800 lbs. capacity per shelf up to 48" length and 600 lbs. per shelf over 48" long.
- Many accessories available allowing you to customize your cart to your needs. Choose from shelf ledges, shelf dividers, side and back enclosure panels, cart covers, label holders. Please inquire about accessories.

### Stem Caster Carts — Open Grid Shelves — 4 Tier

Catalog Number with 5" Casters

Shelf Width/Length (inches)	Approx. Pkd. Wt. (lbs.)	Cat. No. 2-Swivel 2-Brake Resilient Rubber Casters		Cat. No. 2-Swivel 2-Brake Poly Casters	
		Price Each	Price Each	Price Each	Price Each
18 x 36	74	X336BGX3	\$498.00	X336EGX3	\$545.00
18 x 48	86	X356BGX3	575.00	X356EGX3	615.00
18 x 60	98	X366BGX3	630.00	X366EGX3	675.00
24 x 36	82	X536BGX3	580.00	X536EGX3	620.00
24 x 48	98	X556BGX3	650.00	X556EGX3	690.00
24 x 60	114	X566BGX3	740.00	X566EGX3	785.00



Open-Grid Stem Caster Cart

### Stem Caster Carts — Solid Shelves — 4 Tier

Catalog Number with 5" Casters

Shelf Width/Length (inches)	Height (inches)	Approx. Pkd. Wt. (lbs.)	Cat. No. 2-Swivel 2-Brake Resilient Rubber Casters		Price Each
			Price Each	Price Each	
18 x 36	69	74	X336BFX3	\$585.00	
18 x 48	69	90	X356BFX3	655.00	
18 x 60	69	106	X366BFX3	735.00	
24 x 36	69	86	X536BFX3	670.00	
24 x 48	69	106	X556BFX3	745.00	
24 x 60	69	122	X566BFX3	845.00	

### Stem Caster Carts — Solid Bottom Shelves and 4 Open Grid Shelves — 5 Tier

- Approximate cart height—80". Weight capacity of cart is 900 lbs. evenly distributed.

Nominal Width/Length (inches)	Approx. Pkd. Wt. (lbs.)	Cat. No. 2-Swivel 2-Brake Poly Casters		Price Each
		Price Each	Price Each	
18 x 36	82	5X337EGX3	\$645.00	
18 x 48	109	5X357EGX3	735.00	
18 x 60	121	5X367EGX3	815.00	
24 x 36	102	5X537EGX3	745.00	
24 x 48	123	5X557EGX3	835.00	
24 x 60	141	5X567EGX3	950.00	



Solid Shelf Stem Caster Cart  
Shown with optional extended handle. \$55.00

TERMS: 2% ten days, net 30, F.O.B. Factory. We prepay shipping and add to invoice.

# POLYMER UTILITY CARTS

Use for Linen, Dishes, Food, Mail

**Bold Color (BC) Carts in four popular colors.**

Gray (G), Blue (BU), Berry (BY), Black (BL)

**2<sup>3</sup>/<sub>4</sub>" Deep  
Ledge Models  
now available.  
Please call for  
pricing.**

## BC Series Utility Carts – Durable Polymer Plastic Shelves on Plated Frame

- BC carts are available in fresh, modern colors: Gray, Blue, Berry and Black.
- Shelves specially designed to resist staining and wipe clean easily.
- 7/16" deep ship's edge lip around shelf perimeter contains spills.
- Available in 2-shelf, 3-shelf, 3-shelf enclosed end, and 3-shelf, 3-sided enclosed styles.
- Two-shelf and three-shelf models are available in four colors including: Gray, Blue, Berry and Black. Enclosed models are available only in Gray and Blue.
- 4" swivel casters.



Width/Length/Height (in.)	Description	Approx. Pkd. Wt. (lbs.)	Bold Color Catalog No. *	Price Each
18 x 28 x 33 <sup>1</sup> / <sub>4</sub>	2-shelf unit	27 <sup>1</sup> / <sub>2</sub>	<b>BC1627-24</b>	\$135.00
18 x 28 x 33 <sup>1</sup> / <sub>4</sub>	3-shelf unit	33	<b>BC1627-34</b>	155.00
18 x 28 x 33 <sup>1</sup> / <sub>4</sub>	3-shelf enclosed end unit	39	<b>BCE1627-34</b>	190.00
18 x 28 x 33 <sup>1</sup> / <sub>4</sub>	3-shelf, 3-sided enclosed unit	42 <sup>1</sup> / <sub>2</sub>	<b>BC3E1627-34</b>	240.00
21 <sup>1</sup> / <sub>2</sub> x 33 <sup>3</sup> / <sub>4</sub> x 33 <sup>1</sup> / <sub>4</sub>	2-shelf unit	34 <sup>1</sup> / <sub>2</sub>	<b>BC2030-24</b>	145.00
21 <sup>1</sup> / <sub>2</sub> x 33 <sup>3</sup> / <sub>4</sub> x 33 <sup>1</sup> / <sub>4</sub>	3-shelf unit	43	<b>BC2030-34</b>	175.00
21 <sup>1</sup> / <sub>2</sub> x 33 <sup>3</sup> / <sub>4</sub> x 33 <sup>1</sup> / <sub>4</sub>	3-shelf enclosed end unit	49 <sup>3</sup> / <sub>4</sub>	<b>BCE2030-34</b>	240.00
21 <sup>1</sup> / <sub>2</sub> x 33 <sup>3</sup> / <sub>4</sub> x 33 <sup>1</sup> / <sub>4</sub>	3-shelf, 3-sided enclosed unit	50 <sup>1</sup> / <sub>2</sub>	<b>BC3E2030-34</b>	270.00
27 x 39 <sup>1</sup> / <sub>2</sub> x 33 <sup>1</sup> / <sub>4</sub>	2-shelf unit	40 <sup>1</sup> / <sub>2</sub>	<b>BC2636-24</b>	165.00
27 x 39 <sup>1</sup> / <sub>2</sub> x 33 <sup>1</sup> / <sub>4</sub>	3-shelf unit	52	<b>BC2636-34</b>	205.00
27 x 39 <sup>1</sup> / <sub>2</sub> x 33 <sup>1</sup> / <sub>4</sub>	3-shelf enclosed end unit	50	<b>BCE2636-34</b>	280.00
27 x 39 <sup>1</sup> / <sub>2</sub> x 33 <sup>1</sup> / <sub>4</sub>	3-shelf, 3-sided enclosed unit	53 <sup>1</sup> / <sub>2</sub>	<b>BC3E2636-34</b>	315.00

Cart is available in 2-shelf, 3-shelf, and 3-shelf with enclosure panels.

\*Colors available are: Gray (G), Blue (BU), Berry (BY) and Black (BL).

Please specify color when ordering. Enclosure panels available in Gray (G) and Blue (BU) only.

**Weight Load Capacity:  
150 lbs. per shelf.  
400 lbs. per unit.**

**Now available—2-shelf and 3-shelf models with Microban™ Protection in slate blue color. Call for details and pricing.**

## Utility Cart Accessories

Baskets and Bins for Two and Three-Shelf Units  
Available in black only

Description	Fits Cart	Width/Height/Depth (in.)	Approx. Pkd. Wt. (lbs.)	Catalog No.	Price Each
Wastebasket (including holder)	BC1627	17 <sup>3</sup> / <sub>8</sub> x 27 <sup>1</sup> / <sub>2</sub> x 13 <sup>1</sup> / <sub>4</sub>	5.5	<b>BCWB1</b>	\$45.00
Wastebasket (including holder)	BC2030	21 <sup>1</sup> / <sub>4</sub> x 27 <sup>1</sup> / <sub>2</sub> x 13 <sup>1</sup> / <sub>4</sub>	8.0	<b>BCWB2</b>	45.00
Utility Bin (including holder)	BC1627	17 <sup>1</sup> / <sub>2</sub> x 7 <sup>3</sup> / <sub>4</sub> x 14 <sup>1</sup> / <sub>2</sub>	3.8	<b>BCUB1</b>	40.00
Utility Bin (including holder)	BC2030	21 <sup>1</sup> / <sub>4</sub> x 7 <sup>3</sup> / <sub>4</sub> x 14 <sup>1</sup> / <sub>2</sub>	6.0	<b>BCUB2</b>	40.00
Wastebasket Only	—	14 <sup>3</sup> / <sub>8</sub> x 15 <sup>3</sup> / <sub>8</sub> x 10 <sup>3</sup> / <sub>8</sub>	2.8	<b>MF222</b>	25.00
Utility Bin Only	—	16 <sup>3</sup> / <sub>8</sub> x 6 x 11	2.0	<b>UB1</b>	25.00



Three-Shelf Enclosed End Cart with optional wastebasket and utility bin accessories.

**Buy 2 or more carts and take an additional 5% off.**

We gladly accept Mastercard, Visa and American Express.



SINCE 1972, DISTRIBUTORS OF SPECIALTY ITEMS FOR HOSPITALS, NURSING HOMES, INSTITUTIONS

# LATEST PRODUCTS CORP.

P.O. Box 190 • Syosset, New York 11791 • 1-800-288-3547 • Fax 1-516-367-4714 • email LPCORP@aol.com

**Microban® Shelving units cost less than Stainless Steel with many of the same benefits!**

## ADJUSTABLE MICROBAN® SHELVING UNITS

Adjustable sturdy epoxy coated wire shelving constructed with Microban® antimicrobial product protection

Protects against:

- Corrosion
- Bacteria
- Mold
- Mildew
- Fungi that cause odors, stains and product deterioration.

Use in areas such as food service, linen supply, housekeeping, or anywhere a sterile environment is needed.

- Easy to clean polymer shelf mats.

**It's Easy to Adjust Shelves!**

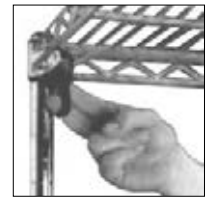

Lift the release at each corner to adjust shelf at 1" increments.



Two units joined together to save money shown above. See page 56 for details.

### Units with 4 shelves and 4 posts – 63" overall height

Model No.	Size (63" Height)	1-2	3 or more
501 EM	18" W x 24" L x 63" H	\$280.00	\$270.00
502 EM	18" W x 30" L x 63" H	295.00	285.00
503 EM	18" W x 36" L x 63" H	300.00	290.00
504 EM	18" W x 42" L x 63" H	335.00	325.00
505 EM	18" W x 48" L x 63" H	340.00	330.00
505 AEM	18" W x 60" L x 63" H	375.00	365.00
506 EM	18" W x 72" L x 63" H	435.00	425.00
507 EM	21" W x 24" L x 63" H	310.00	300.00
508 EM	21" W x 30" L x 63" H	315.00	305.00
509 EM	21" W x 36" L x 63" H	320.00	310.00
510 EM	21" W x 42" L x 63" H	355.00	345.00
511 EM	21" W x 48" L x 63" H	360.00	350.00
512 EM	21" W x 60" L x 63" H	410.00	400.00
513 EM	21" W x 72" L x 63" H	485.00	475.00
514 EM	24" W x 24" L x 63" H	325.00	315.00
515 EM	24" W x 30" L x 63" H	330.00	320.00
516 EM	24" W x 36" L x 63" H	335.00	325.00
517 EM	24" W x 42" L x 63" H	390.00	380.00
518 EM	24" W x 48" L x 63" H	395.00	385.00
519 EM	24" W x 60" L x 63" H	440.00	430.00
520 EM	24" W x 72" L x 63" H	510.00	500.00

### Units with 5 shelves and 4 posts – 74" overall height

Model No.	Size (74" Height)	1-2	3 or more
521 EM	18" W x 24" L x 74" H	\$335.00	\$325.00
522 EM	18" W x 30" L x 74" H	350.00	340.00
523 EM	18" W x 36" L x 74" H	355.00	345.00
524 EM	18" W x 42" L x 74" H	400.00	390.00
525 EM	18" W x 48" L x 74" H	405.00	395.00
526 EM	18" W x 60" L x 74" H	450.00	440.00
527 EM	18" W x 72" L x 74" H	530.00	520.00
528 EM	21" W x 24" L x 74" H	370.00	360.00
528 AEM	21" W x 30" L x 74" H	380.00	370.00
529 EM	21" W x 36" L x 74" H	385.00	375.00
530 EM	21" W x 42" L x 74" H	430.00	420.00
531 EM	21" W x 48" L x 74" H	435.00	425.00
531 AEM	21" W x 60" L x 74" H	495.00	485.00
531 BEM	21" W x 72" L x 74" H	590.00	580.00
532 EM	24" W x 24" L x 74" H	390.00	380.00
533 EM	24" W x 30" L x 74" H	395.00	385.00
534 EM	24" W x 36" L x 74" H	400.00	390.00
535 EM	24" W x 42" L x 74" H	475.00	465.00
536 EM	24" W x 48" L x 74" H	480.00	470.00
537 EM	24" W x 60" L x 74" H	535.00	525.00
538 EM	24" W x 72" L x 74" H	620.00	610.00

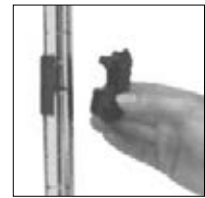

Sleeves & wedges attach easily to posts. No extra charge.

**Shelving Unit Covers available. See pages 10 and 11.**

Microban® antimicrobial product protection has an established performance record in many commercial, healthcare and food service settings. Microban® product protection is built-in during the manufacturing process and it is designed to last for the life of the product.

Microban® product protection utilizes an antimicrobial additive that is effective against a wide range of bacteria, mold and fungi. Microban® product protection has received NSF International Certification for food contact and water applications.

**See following pages for chrome plated shelves.**

**Contact us for Microban® shelving unit accessories including dividers, ledges, side and back enclosure panels, label holders, shelf markers, baskets and more!**





63" Height—four shelves

See  
Pages 61 - 63  
for Shelving  
Accessories

## ADJUSTABLE STURDY SHELVING CHROME PLATED

FOR STORAGE OF  
LINEN • BLANKETS • GOWNS  
PILLOWS • CARTONS, ETC.

Select 63" or 74" height (Next page)  
and a variety of sizes.

All units consist of four posts, four  
shelves and are fully adjustable.

*It's Easy to Adjust  
Shelves!*

Model No.	Size (63" Height)	1-2	3 or more
101 EM	18" W x 24" L x 63" H	\$220.00	\$215.00
102 EM	18" W x 30" L x 63" H	225.00	220.00
103 EM	18" W x 36" L x 63" H	230.00	225.00
104 EM	18" W x 42" L x 63" H	260.00	255.00
105 EM	18" W x 48" L x 63" H	265.00	260.00
105 AEM	18" W x 60" L x 63" H	285.00	280.00
106 EM	18" W x 72" L x 63" H	325.00	320.00
107 EM	21" W x 24" L x 63" H	245.00	240.00
108 EM	21" W x 30" L x 63" H	250.00	245.00
109 EM	21" W x 36" L x 63" H	255.00	250.00
110 EM	21" W x 42" L x 63" H	280.00	275.00
111 EM	21" W x 48" L x 63" H	285.00	280.00
112 EM	21" W x 60" L x 63" H	315.00	310.00
113 EM	21" W x 72" L x 63" H	360.00	355.00
114 EM	24" W x 24" L x 63" H	250.00	245.00
115 EM	24" W x 30" L x 63" H	260.00	255.00
116 EM	24" W x 36" L x 63" H	265.00	260.00
117 EM	24" W x 42" L x 63" H	300.00	295.00
118 EM	24" W x 48" L x 63" H	305.00	300.00
119 EM	24" W x 60" L x 63" H	340.00	335.00
120 EM	24" W x 72" L x 63" H	385.00	380.00



Lift the release  
at each corner  
to adjust shelf at  
1" increments.

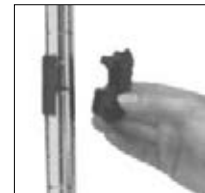

Sleeves &  
wedges attach  
easily to posts.  
No extra charge.

*Just a "Flick" of the Fingers  
Lowers or Raises Shelving to  
Desired Height.*

Other sizes/configurations available as well as stainless steel shelving,  
mobile units and shelving covers.

Do we have your email address?

Please let us know so we can offer you our monthly email specials.



SINCE 1972, DISTRIBUTORS OF SPECIALTY ITEMS FOR HOSPITALS, NURSING HOMES, INSTITUTIONS

# LATEST PRODUCTS CORP.

P.O. Box 190 • Syosset, New York 11791 • 1-800-288-3547 • Fax 1-516-367-4714 • email LPCORP@aol.com

See  
Pages 61 - 63  
for Shelving  
Accessories

## ADJUSTABLE CHROME PLATED STORAGE SHELVING WITH 74" HEIGHT AND FIVE SHELVES

*Let Your "Fingers Do the Adjusting"  
with Adjustable Shelves.*



74" Height—five shelves

Model No.	Size (74" Height)	1-2	3 or more
121 EM	18" W x 24" L x 74" H	\$260.00	\$250.00
122 EM	18" W x 30" L x 74" H	265.00	255.00
123 EM	18" W x 36" L x 74" H	270.00	260.00
124 EM	18" W x 42" L x 74" H	310.00	300.00
125 EM	18" W x 48" L x 74" H	315.00	305.00
126 AEM	18" W x 60" L x 74" H	350.00	340.00
127 EM	18" W x 72" L x 74" H	405.00	395.00
128 EM	21" W x 24" L x 74" H	290.00	280.00
128 AEM	21" W x 30" L x 74" H	300.00	290.00
129 EM	21" W x 36" L x 74" H	305.00	295.00
130 EM	21" W x 42" L x 74" H	340.00	330.00
131 EM	21" W x 48" L x 74" H	345.00	335.00
131 AEM	21" W x 60" L x 74" H	385.00	375.00
131 BEM	21" W x 72" L x 74" H	445.00	435.00
132 EM	24" W x 24" L x 74" H	300.00	290.00
133 EM	24" W x 30" L x 74" H	315.00	305.00
134 EM	24" W x 36" L x 74" H	320.00	310.00
135 EM	24" W x 42" L x 74" H	370.00	360.00
136 EM	24" W x 48" L x 74" H	375.00	365.00
137 EM	24" W x 60" L x 74" H	420.00	410.00
138 EM	24" W x 72" L x 74" H	480.00	470.00

**Other sizes/configurations available as well as stainless steel shelving and mobile units.**

**Shelving Unit Covers available.**

**See pages 10 and 11.**

*See previous page for complete description of adjustable features.*

### Money Saving Idea

Expand your existing shelving by adding on additional shelves to existing unit. Using "S" hooks to attach—saves two posts. To compute costs, use the unit pricing for the size you need and deduct 5% for the posts not needed. S hooks included.



END-TO-END



Starter

Add-On

**TERMS: 2% ten days, net 30, F.O.B. Factory. We prepay shipping and add to invoice.**

# STAINLESS STEEL HEAVY DUTY MULTI-PURPOSE TABLES

## 30 and 36 inches wide

### Multi-Purpose Tables

Built for cleanliness and stability.

- Seamless 14-gauge stainless steel work surface and support structure.
- Shipped knocked down and can be assembled in minutes without tools.
- Accessories available include stainless steel drawers, stainless steel keyboard trays and swing arm for computer monitor.

All tables are 34" high and come with stationary posts and leveling feet and choice of bottom shelf, 3-sided frame or H-frame.

### Standard Process Tables — 30" Wide

Length (in.)	Post Material	Bottom Shelf Material	Bottom 3-Sided Frame Material	Bottom H-Frame Material	Cat. No.	Price Each
48	SS	SS	—	—	WT305FS	\$ 815.00
60	SS	SS	—	—	WT306FS	870.00
72	SS	SS	—	—	WT307FS	940.00
96	SS	SS	—	—	WT309FS	1,150.00
48	SS	—	SS	—	WT305US	670.00
60	SS	—	SS	—	WT306US	720.00
72	SS	—	SS	—	WT307US	790.00
96	SS	—	SS	—	WT309US	935.00
60	SS	—	—	SS	WT306HS	725.00
72	SS	—	—	SS	WT307HS	785.00
96	SS	—	—	SS	WT309HS	940.00

SS = Stainless Steel

Quantity discounts available — please inquire.



Process Table with H-Frame



Process Table with optional Bottom Shelf which is adjustable in 2" increments

**All tables—  
buy 2 or more  
and take an  
additional 5% off.**

### Standard Process Tables — 36" Wide

Length (in.)	Post Material	Bottom Shelf Material	Bottom 3-Sided Frame Material	Bottom H-Frame Material	Cat. No.	Price Each
60	SS	SS	—	—	WT366FS	\$ 995.00
72	SS	SS	—	—	WT367FS	1,075.00
96	SS	SS	—	—	WT369FS	1,295.00
60	SS	—	SS	—	WT366US	845.00
72	SS	—	SS	—	WT367US	910.00
96	SS	—	SS	—	WT369US	1,070.00
60	SS	—	—	SS	WT366HS	840.00
72	SS	—	—	SS	WT367HS	910.00
96	SS	—	—	SS	WT369HS	1,070.00

SS = Stainless Steel

Quantity discounts available — please inquire.



Process Table with 3-Sided Frame

**All tables manufactured of stainless steel.  
Please contact us for non-stainless steel tables.  
See page 58 for additional tables.**

#### FIVE EASY WAYS TO ORDER:

1. **By Mail:** P.O. Box 190 • Syosset, NY 11791
2. **Toll-Free:** 1-800-288-3547

3. **By Fax:** 1-516-367-4714
4. **By email:** LPCORP@aol.com

5. **Through our website:** www.LatestProducts.net



SINCE 1972, DISTRIBUTORS OF SPECIALTY ITEMS FOR HOSPITALS, NURSING HOMES, INSTITUTIONS

# LATEST PRODUCTS CORP.

P.O. Box 190 • Syosset, New York 11791 • 1-800-288-3547 • Fax 1-516-367-4714 • email LPCORP@aol.com

## STAINLESS STEEL HEAVY DUTY MULTI-PURPOSE TABLES

### Standard Process Tables – 44" Wide

Length (in.)	Post Material	Bottom Shelf Material	Bottom 3-Sided Frame Material	Bottom H-Frame Material	Cat. No.	Price Each
60	SS	SS	—	—	WT446FS	\$1,085.00
72	SS	SS	—	—	WT447FS	1,160.00
96	SS	SS	—	—	WT449FS	1,380.00
60	SS	—	SS	—	WT446US	930.00
72	SS	—	SS	—	WT447US	995.00
96	SS	—	SS	—	WT449US	1,160.00
60	SS	—	—	SS	WT446HS	930.00
72	SS	—	—	SS	WT447HS	995.00
96	SS	—	—	SS	WT449HS	1,160.00

SS = Stainless Steel

Quantity discounts available – please inquire.

### Mobile Process Tables on Wheels

All Mobile Process Tables are 34" high. Mobile units have special posts and four 5" poly casters — 2 swivel/2 brake.

### Mobile Process Tables — 30" Wide

Length (in.)	Post Material	Bottom Shelf Material	Bottom 3-Sided Frame Material	Bottom H-Frame Material	Cat. No.	Price Each
48	SS	SS	—	—	MWT305FS	\$1,030.00
60	SS	SS	—	—	MWT306FS	1,085.00
72	SS	SS	—	—	MWT307FS	1,150.00
96	SS	SS	—	—	MWT309FS	1,365.00
48	SS	—	SS	—	MWT305US	875.00
60	SS	—	SS	—	MWT306US	935.00
72	SS	—	SS	—	MWT307US	995.00
96	SS	—	SS	—	MWT309US	1,150.00
60	SS	—	—	SS	MWT306HS	935.00
72	SS	—	—	SS	MWT307HS	985.00
96	SS	—	—	SS	MWT309HS	1,160.00

SS = Stainless Steel

Quantity discounts available – please inquire.

### Process Tables with Utility Racks

All Process Tables with Overhead utility racks are 30" wide and have rear posts that are approximately 88" high. Cantilever shelves for overhead models are sold separately. Cantilever shelf adds convenient space above storage unit. Please inquire.

Length (in.)	Post Material	Bottom Shelf Material	Bottom 3-Sided Frame Material	Cat. No.	Price Each
60	SS	SS	—	WTC306FS	\$ 985.00
72	SS	SS	—	WTC307FS	1,050.00
96	SS	SS	—	WTC309FS	1,265.00
60	SS	—	SS	WTC306US	835.00
72	SS	—	SS	WTC307US	895.00
96	SS	—	SS	WTC309US	1045.00

All overhead models are fitted with stationary posts and leveling feet.

SS = Stainless Steel



Process Table with H-Frame



Mobile Process Table with 3 sided frame



Process Table with Overhead Utility Rack

Please measure doors and areas carefully before ordering as all returns are subject to a 25% restocking fee, plus freight charges incurred.

# SUPER HEAVY DUTY DUNNAGE RACKS

## Mobile Dunnage Racks (Heavy Duty)

These easy-to-maneuver racks feature two swivel and two swivel/brake casters; with non-marking 5" polyurethane tread casters.

- Support frames: 1" square tubing.
- Removable wire mat: 5/16" diameter wire.

Width/Length (in.)	Pkd. Wt. (lbs.)	Cat. No. Chrome	Price Each	Cat. No. Stainless	Price Each
18 x 36	42	<b>MHP33C</b>	\$340.00	<b>MHP33S</b>	\$585.00
18 x 48	50	<b>MHP35C</b>	370.00	<b>MHP35S</b>	690.00
24 x 36	48	<b>MHP53C</b>	350.00	<b>MHP53S</b>	625.00
24 x 48	54	<b>MHP55C</b>	380.00	<b>MHP55S</b>	735.00

Maximum distributed static load capacity is 800 lbs.

**Note:** These units are designed for only the 5HP and 5HPB casters, which are shipped assembled with the special posts.



Mobile Dunnage Rack

## HD Super Duty Dunnage Racks

Stores more than a ton safely off the floor.

- 48" rack has a 3,000 pound static load capacity (uniformly distributed); 60" rack carries up to 2,400 pounds.
- HD Super design features fast, secure assembly without tools.
- Posts of 1 5/8" diameter provide greater rigidity.
- HD Super™ Dunnage Racks are 16 1/4" high including cap and leveling bolt.

Width/Length (in.)	Pkd. Wt. (lbs.)	Cat. No. Chrome	Price Each	Cat. No. Stainless	Price Each
18 x 48	52	<b>HDP35C</b>	\$345.00	<b>HDP35S</b>	\$695.00
18 x 60	62	<b>HDP36C</b>	390.00	<b>HDP36S</b>	795.00
24 x 48	57	<b>HDP55C</b>	365.00	<b>HDP55S</b>	745.00
24 x 60	66	<b>HDP56C</b>	415.00	<b>HDP56S</b>	860.00

Maximum capacity 2,400 pounds uniformly distributed static load on the 60" length racks; 3,000 pounds on the 48" length racks. **Note:** Capacity will be reduced and the unit will become less stable if the 3-sided frame is mounted higher than 6" from the floor.



HD Super Dunnage Rack

## HD Super Duty Dunnage Shelves

- 48" rack has a 3,000 pound static load capacity (uniformly distributed); 60" rack carries up to 2,400 pounds. H.D. 1 5/8" posts.
- Removable wire deck (5/16" diameter wire) lifts off for easy cleaning.
- Support frames: 1 1/2" square tubing. Removable deck.

Width/Length (in.)	Pkd. Wt. (lbs.)	Cat. No. Chrome	Price Each	Cat. No. Stainless	Price Each
18 x 48	35	<b>1848HDRC</b>	\$225.00	<b>1848HDRS</b>	\$510.00
18 x 60	43	<b>1860HDRC</b>	275.00	<b>1860HDRS</b>	595.00
24 x 48	38	<b>2448HDRC</b>	245.00	<b>2448HDRS</b>	555.00
24 x 60	47	<b>2460HDRC</b>	285.00	<b>2460HDRS</b>	655.00

**Important:** In stationary shelving, stability decreases as the ratio of height to width increases and when heavier loads are placed on upper shelves. Keep units as wide and low as possible, using the dunnage shelf as the bottom shelf. If two dunnage shelves are being used, both should be placed within the lower half of the unit.

Dunnage shelves can replace standard shelves for extremely heavy loads.

Refer to storage shelving, pages 55-56.



HD Super Dunnage Shelf





## STANDARD AND HEAVY DUTY DUNNAGE RACKS

### Dunnage Platforms (Standard Duty)

Space-saving platforms let you keep bulky items off the floor.

- Open wire provides air circulation and minimizes dust.
- All platforms use 13P or 13PS posts — height 14<sup>5</sup>/<sub>8</sub>" including mat, cap and leveling bolt.

Width/Length (in.)	Pkd. Wt. (lbs.)	Cat. No. Chrome	Price Each	Cat. No. Stainless	Price Each
18 x 24	11	P1824NC	\$73.00	P1824NS	\$206.00
18 x 30	12	P1830NC	75.00	P1830NS	208.00
18 x 36	14	P1836NC	76.00	P1836NS	210.00
21 x 24	12	P2124NC	78.00	P2124NS	222.00
21 x 30	13	P2130NC	80.00	P2130NS	224.00
21 x 36	15	P2136NC	82.00	P2136NS	226.00
24 x 24	13	P2424NC	80.00	P2424NS	235.00
24 x 30	15	P2430NC	82.00	P2430NS	237.00
24 x 36	17	P2436NC	84.00	P2436NS	240.00



Dunnage Platform

### Dunnage Racks with Mat (Heavy Duty)

A space-efficient way to store large, bulky items off the floor.

- Removable top mat lifts off for cleaning.
- Dunnage racks are 14<sup>1</sup>/<sub>2</sub>" high including mat, cap and leveling bolt.

Width/Length (in.)	Pkd. Wt. (lbs.)	Cat. No. Chrome	Price Each	Cat. No. Stainless	Price Each
18 x 24	22	HP31C	\$140.00		
18 x 30	25	HP32C	148.00		
18 x 36	30	HP33C	156.00	HP33S	\$385.00
18 x 48	38	HP35C*	186.00	HP35S*	492.00
24 x 24	28	HP51C	149.00		
24 x 30	30	HP52C	159.00		
24 x 36	36	HP53C	170.00	HP53S	424.00
24 x 48	42	HP55C*	200.00	HP55S*	540.00



Dunnage Rack with Mat

Note: Maximum distributed static load capacity for stationary dunnage racks is 1,600 lbs., except on units marked \* which have a 1,300 lb. capacity.

### Dunnage Shelves (Heavy Duty)

Enhance the weight-bearing capacity of your system.

- 36" shelf holds 1,600 pounds (uniformly distributed); 48" shelves carry up to 1,300 pounds; 60" shelves bear up to 1,000 pounds.
- Removable wire mat: 5/16" diameter wire.
- Support frames: 1" square tubing lifts off for easy cleaning.

Width/Length (in.)	Pkd. Wt. (lbs.)	Cat. No. Chrome	Price Each	Cat. No. Stainless	Price Each
18 x 24	14	1824DRC	\$ 88.00		
18 x 30	18	1830DRC	96.00		
18 x 36	21	1836DRC	103.00	1836DRS	\$296.00
18 x 48	28	1848DRC	118.00	1848DRS	359.00
18 x 60	34	1860DRC	136.00	1860DRS	419.00
24 x 24	16	2424DRC	95.00		
24 x 30	20	2430DRC	104.00		
24 x 36	24	2436DRC	112.00	2436DRS	319.00
24 x 48	30	2448DRC	126.00	2448DRS	384.00
24 x 60	37	2460DRC	150.00	2460DRS	461.00

Dunnage shelves can replace standard shelves for extremely heavy loads.

Refer to storage shelving, pages 55-56.



Dunnage Shelf

**Important:** In stationary shelving, stability decreases as the ratio of height to width increases and when heavier loads are placed on upper shelves. Shelving stability is attained by keeping units as wide and low as possible, and placing heavy loads low on the shelving unit.

Please place us on your bid list for all products featured in this catalog or any housekeeping or laundry/linen products you use.

# SHELVING ACCESSORIES TO ORGANIZE LINEN AND SUPPLIES

## Bins

Convenient way to organize and identify small items.

- Hopper-front design allows for easy access and clear visibility.
- Lightweight, durable polypropylene and polyethylene bins have molded front slots to accept labels.

## Shelf Bins — Nesting

These bins are sized to work on the two most popular shelf widths 18" and 24" for efficient handling and exchange.

Outside Dimensions Width/Length/Height (inches)	Approx. Pkd. Wt./Ctn. (lbs.)	Bin Carton Quantity	Bin Color	Bin Cat. No.	Price Each	Divider Cat. No.	Divider Carton Quantity	Price Per Carton
11 <sup>5</sup> / <sub>8</sub> x 4 <sup>1</sup> / <sub>8</sub> x 4	9	24	Yellow	MB30120Y	\$ 4.00	MB40120	24	\$16.50
11 <sup>5</sup> / <sub>8</sub> x 6 <sup>1</sup> / <sub>8</sub> x 4	7	12	Yellow	MB30130Y	5.00	MB40130	24	20.00
17 <sup>7</sup> / <sub>8</sub> x 4 <sup>1</sup> / <sub>8</sub> x 4	7	12	Yellow	MB30128Y	5.25	MB40120	24	16.50
17 <sup>7</sup> / <sub>8</sub> x 6 <sup>1</sup> / <sub>8</sub> x 4	9	12	Yellow	MB30138Y	7.50	MB40130	24	20.00
17 <sup>7</sup> / <sub>8</sub> x 11 <sup>1</sup> / <sub>8</sub> x 4	15	12	Yellow	MB30178Y	17.00	MB40170	24	43.00
23 <sup>3</sup> / <sub>8</sub> x 4 <sup>1</sup> / <sub>8</sub> x 4	11	12	Yellow	MB30124Y	12.00	MB40120	24	16.50
23 <sup>3</sup> / <sub>8</sub> x 6 <sup>1</sup> / <sub>8</sub> x 4	8	6	Yellow	MB30164Y	13.00	MB40130	24	20.00
23 <sup>3</sup> / <sub>8</sub> x 11 <sup>1</sup> / <sub>8</sub> x 4	11	6	Yellow	MB30174Y	20.00	MB40170	24	43.00

**Note:** Bins are available in carton quantities only. Bins above are priced per each, but must be ordered in multiples of carton quantity. (For example: MB30138Y is available in quantities of 12, 24, 36. Prices refers to the price of 1 bin.) Dividers are available in carton quantities only. Dividers are sold by the carton and priced by the carton. (For example: 1 MB40120 = 24 dividers, the price is for 24 dividers.)

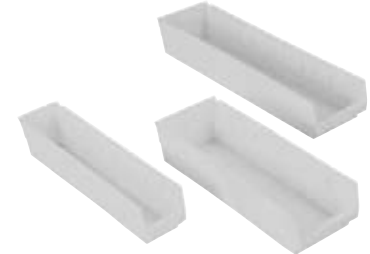

Shelf Bins — Nesting



Supply Bins — Stacking

## Supply Bins — Stacking

Stackable design maximizes vertical storage efficiency. Reinforced design adds strength and prevents spreading.

Outside Dimensions Width/Length/Height (inches)	Approx. Pkd. Wt./Ctn. (lbs.)	Bin Carton Quantity	Bin Color	Bin Cat. No.	Price Each	Divider Cat. No.	Divider Carton Quantity	Price Per Carton
10 <sup>7</sup> / <sub>8</sub> x 5 <sup>1</sup> / <sub>2</sub> x 5	10	12	Blue	MB30230B	\$ 9.00	MB40230	6	\$16.00
10 <sup>7</sup> / <sub>8</sub> x 11 x 5	10	6	Blue	MB30235B	12.00	MB40230	6	16.00
14 <sup>3</sup> / <sub>4</sub> x 5 <sup>1</sup> / <sub>2</sub> x 5	13	12	Blue	MB30234B	14.00	N/A		
14 <sup>3</sup> / <sub>4</sub> x 8 <sup>1</sup> / <sub>4</sub> x 7	24	12	Blue	MB30240B	15.00	MB40245	6	21.00
14 <sup>3</sup> / <sub>4</sub> x 16 <sup>1</sup> / <sub>2</sub> x 7	21	6	Blue	MB30250B	20.00	MB40245	6	21.00
18 x 8 <sup>1</sup> / <sub>4</sub> x 9	17	6	Blue	MB30265B*	27.00	MB40265	6	34.00
20 x 12 <sup>5</sup> / <sub>8</sub> x 6	9	3	Blue	MB30281B*	26.00	N/A		
20 x 18 <sup>3</sup> / <sub>8</sub> x 12	7	1	Blue	MB30283B*	45.00	N/A		

**Note:** MB30234B, MB30281B, MB30283B — no dividers available. Bins feature a full-width hanger lip that is designed for use with hanging systems. Bins are available in carton quantities only. Bins above are priced per each but must be ordered in multiples of carton quantity. (For example: MB30235B is available in quantities of 6, 12, 18. Price refers to the prices of 1 bin.) Dividers are available in carton quantities only. Dividers are sold by the carton and priced by the carton. (For example: 1 MB40230 = 6 dividers, the price is for 6 dividers.)



MB30283B



MB34240G

## Bulk Supply Tub — Nesting

Ruggedly constructed, perfect for storing large bulky items.

Outside Dimensions Width/Length/Height (inches)	Approx. Pkd. Wt./Ctn. (lbs.)	Carton Quantity	Bin Color	Bin Cat. No.	Price Each
24 <sup>1</sup> / <sub>2</sub> x 19 x 9 <sup>1</sup> / <sub>2</sub>	20	6	Gray	MB34240G	\$42.00

**Note:** Bins are available in carton quantities only. Bins above are priced per each, but must be ordered in multiples of carton quantity. (For example: MB34240G is available in quantities of 6, 12, 18. Prices refers to the price of 1 bin.)

## Snap-On Hooks

Multi-purpose hooks in three styles attach to hanger rails, mounting rails or shelves for instant access.

Description	Height (in.)	Cat. No. Chrome	Cat. No. Black	Price Each
Style A — Small	3 <sup>7</sup> / <sub>16</sub>	HK23C	HK23B	\$4.00
Style B — Large	3 <sup>7</sup> / <sub>16</sub>	HK25C	HK25B	5.00
Style C — Double	3 <sup>7</sup> / <sub>16</sub>	HK26C		7.00



Snap-on Hooks

Minimum accessory order is \$250 or a \$45 shipping charge will apply. You can achieve minimum order amount by ordering other products in our catalog.



SINCE 1972, DISTRIBUTORS OF SPECIALTY ITEMS FOR HOSPITALS, NURSING HOMES, INSTITUTIONS

# LATEST PRODUCTS CORP.

P.O. Box 190 • Syosset, New York 11791 • 1-800-288-3547 • Fax 1-516-367-4714 • email LPCORP@aol.com

## SHELVING ACCESSORIES TO ORGANIZE LINEN AND SUPPLIES

### Label Holders - 1 1/4"

It's easy to identify shelf contents with these snap-on plastic holders, available in a variety of sizes. Labels not included. Gray. Holds most commercial 1 1/4" labels.



1 1/4" Label Holder

Label Size (in.)	Fits Shelf Size (in.)	Cat. No.	Price Each
3 x 1 1/4	All	9990P	\$ 3.00
13 x 1 1/4	18	9990P1	4.15
19 x 1 1/4	24	9990P2	6.00
25 x 1 1/4	30	9990P30	6.75
31 x 1 1/4	36	9990P3	7.50
43 x 1 1/4	48	9990P4	9.40
55 x 1 1/4	60	9990P5	13.00

For Cantilever Shelves, use 3" label holder only.

### Slanted Label Holders

Gray solid plastic holder puts 1 1/4" labels on slant for easier viewing.



Slanted Label Holder

Label Size (in.)	Fits Shelf Size (in.)	Cat. No.	Price Each
3 x 1 1/4	All	9990SL	\$ 3.00
13 x 1 1/4	18	9990SL1	4.15
19 x 1 1/4	24	9990SL2	6.00
25 x 1 1/4	30	9990SL30	6.75
31 x 1 1/4	36	9990SL3	7.50
43 x 1 1/4	48	9990SL4	9.40
55 x 1 1/4	60	9990SL5	13.00

For Cantilever Shelves, use 3" label holder only.

### Clear Label Holders

Clear plastic allows decorator colors to show through. Holds most commercial 1 1/4" labels.



Clear Label Holder

Label Size (in.)	Fits Shelf Size (in.)	Cat. No.	Price Each
3 x 1 1/4	All	9990CL	\$ 3.00
13 x 1 1/4	18	9990CL1	4.15
19 x 1 1/4	24	9990CL2	6.00
25 x 1 1/4	30	9990CL30	6.75
31 x 1 1/4	36	9990CL3	7.50
43 x 1 1/4	48	9990CL4	9.40
55 x 1 1/4	60	9990CL5	13.00

For Cantilever Shelves, use 3" label holder only.

### Dividers for Wire Shelves

Keep shelf contents orderly with these 8" high, snap-in-place dividers.

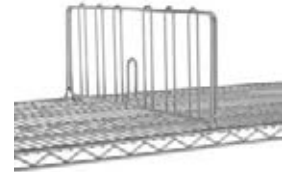

Shelf Divider - Wire Shelf

Shelf Width (in.)	Cat. No. Chrome	Price Each	Cat. No. Stainless	Price Each
14	DD14C	\$12.00	DD14S	\$35.00
18	DD18C	14.00	DD18S	38.00
21	DD21C	16.00	DD21S	43.00
24	DD24C	19.00	DD24S	47.00
30	DD30C	22.00	DD30S	57.00
36	DD36C	26.00	DD36S	68.00

### Dividers for Solid Shelves

The easy way to keep shelves orderly. 8" high dividers attach with a spring clip.

Length (in.)	Cat. No. Chrome	Price Each	Cat. No. Stainless	Price Each
14	DD14FC	\$13.00	—	—
18	DD18FC	15.00	DD18FS	\$43.00
21	DD21FC	17.00	—	—
24	DD24FC	20.00	DD24FS	52.00



Shelf Divider - Solid Shelf

### Ledges — Side and Back for Wire Shelves

For stationary or mobile installations, stackable ledges prevent items from protruding or falling.

Length (in.)	1" HIGH LEDGES			4" HIGH LEDGES			
	Cat. No. Chrome	Price Each	Cat. No. Stainless	Cat. No. Chrome	Price Each	Cat. No. Stainless	
14	L14N-1C	\$ 8.00	L14N-1S	L14N-4C	\$11.00	L14N-4S	\$22.00
18	L18N-1C	9.00	L18N-1S	L18N-4C	12.00	L18N-4S	24.00
21	L21N-1C	10.00	L21N-1S	L21N-4C	13.00	L21N-4S	28.00
24	L24N-1C	11.00	L24N-1S	L24N-4C	14.00	L24N-4S	30.00
30	L30N-1C	12.00	L30N-1S	L30N-4C	16.00	L30N-4S	36.00
36	L36N-1C	13.00	L36N-1S	L36N-4C	19.00	L36N-4S	42.00
42	L42N-1C	14.00	L42N-1S	L42N-4C	22.00	L42N-4S	52.00
48	L48N-1C	15.00	L48N-1S	L48N-4C	23.00	L48N-4S	57.00
54	L54N-1C	17.00	L54N-1S	L54N-4C	24.00	L54N-4S	62.00
60	L60N-1C	18.00	L60N-1S	L60N-4C	25.00	L60N-4S	67.00
72	L72N-1C	19.00	L72N-1S	L72N-4C	28.00	L72N-4S	77.00



4" Ledges - Wire Shelf

Minimum accessory order is \$250 or a \$45 shipping charge will apply. You can achieve minimum order amount by ordering other products in our catalog.

# SHELVING ACCESSORIES TO ORGANIZE LINEN AND SUPPLIES

## Decorator Shelf Inlays

Hardboard mats prevent small items from falling through wire shelves. Fit between posts and level with top of shelf edge.

Width/Length (in.)	Description	Cat. No.	Price Each
14 x 36	Reversible, Black and White	<b>1436BWI</b>	\$21.00
14 x 48	Reversible, Black and White	<b>1448BWI</b>	22.00
18 x 24	Reversible, Black and White	<b>1824BWI</b>	21.00
18 x 36	Reversible, Black and White	<b>1836BWI</b>	22.00
18 x 48	Reversible, Black and White	<b>1848BWI</b>	23.00
24 x 24	Reversible, Black and White	<b>2424BWI</b>	22.00
24 x 36	Reversible, Black and White	<b>2436BWI</b>	25.00
24 x 48	Reversible, Black and White	<b>2448BWI</b>	26.00



Decorator Shelf Inlays

## Clear Shelf Inlays

Nearly invisible plastic mat retains open-wire look of shelves and allows light penetration.

Width/Length (in.)	Cat. No.	Price 4-Pack	Width/Length (in.)	Cat. No.	Price 4-Pack
14 x 36	<b>1436CI-4</b>	\$42.00	21 x 36	<b>2136CI-4</b>	\$46.00
14 x 48	<b>1448CI-4</b>	50.00	21 x 48	<b>2148CI-4</b>	52.00
14 x 60	<b>1460CI-4</b>	58.00	21 x 60	<b>2160CI-4</b>	60.00
18 x 36	<b>1836CI-4</b>	44.00	24 x 36	<b>2436CI-4</b>	46.00
18 x 48	<b>1848CI-4</b>	52.00	24 x 48	<b>2448CI-4</b>	54.00
18 x 60	<b>1860CI-4</b>	60.00	24 x 60	<b>2460CI-4</b>	62.00



Clear Shelf Inlays

## Ledges for Solid Shelves

Sturdy 4" high ledges contain items on shelves. Spring-clip tabs included.

Length (in.)	Cat. No. Chrome	Price Each	Cat. No. Stainless	Price Each
14	<b>L14WC</b>	\$11.00	<b>L14WS</b>	\$23.00
18	<b>L18WC</b>	12.00	<b>L18WS</b>	24.00
21	<b>L21WC</b>	13.00	<b>L21WS</b>	26.00
24	<b>L24WC</b>	14.00	<b>L24WS</b>	28.00
30	<b>L30WC</b>	17.00	<b>L30WS</b>	35.00
36	<b>L36WC</b>	18.00	<b>L36WS</b>	41.00
42	<b>L42WC</b>	19.00	<b>L42WS</b>	45.00
48	<b>L48WC</b>	23.00	<b>L48WS</b>	52.00
60	<b>L60WC</b>	25.00	<b>L60WS</b>	60.00



4" Ledges – Solid Shelf

Other accessories available—please inquire for pricing.



Chrome Baskets



Color Identification  
Tubes



Display Hanger



Waterfall Hanger



Undershelf Slide



File Baskets

Minimum accessory order is \$250 or a \$45 shipping charge will apply. You can achieve minimum order amount by ordering other products in our catalog.



## HOUSEKEEPING AND MAID CARTS

### HOUSEKEEPING CART

This versatile cart can carry everything you need to service 10-12 rooms. The 6" deep top tray helps prevent accidental spills of cleaning supplies. Complete with large collection bag, 10" casters to move easily over bumps and tracks and rubber bumpers on all corners to protect walls and furniture.

Locking doors optional—see M-Door pricing at bottom of page.

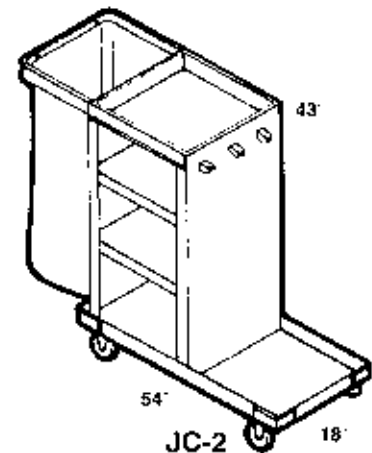
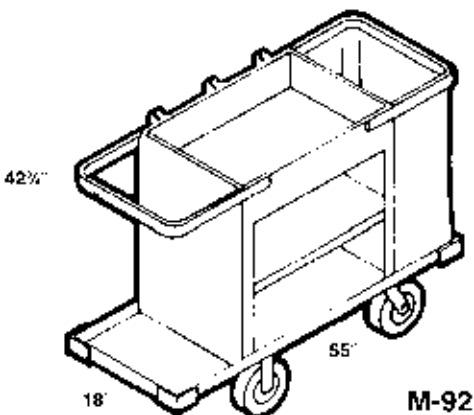

### COMPACTS

Designed for economy. Sturdy enough for the toughest job. The compact size, easy storage and maneuverability make this cart perfect for smaller jobs and emergencies.

Locking doors optional—see JC and JCS-Door pricing at bottom of page.

- Quiet, 10" Casters, 2 Swivel, 2 Fixed
- Large Capacity Collection Bags Can Be Fitted to Both Ends
- Extra Deep Supply Tray
- Optional Locking Door
- Rubber Bumpers On All Corners
- Ships Knocked Down to Save Freight
- Manufactured from Silvertone Powder Coated Metal

- Designed for Simplicity, Economy
- Adjustable Shelves in Supply Compartment
- Optional Security of Locking Door
- Handle Telescopes for Easy Storage
- 4" Casters, 2 Swivel, 2 Fixed
- Clips & Hooks for Holding Utensils
- Epoxy Coated Tray to Resist Rust and Corrosion
- Large Capacity Collection Bag

CATALOG NUMBER	DESCRIPTION	WEIGHT	PRICE
M-92	Fixed Shelf, Body 18" W x 33" H x 31" L Overall with Casters 18" W x 42 <sup>3</sup> / <sub>4</sub> " H x 55" L Complete with One Canvas White Bag or Blue Vinyl Bag	105 lbs.	\$475.00
M-Door	Baked Enamel Two Door Assembly with Flush Lock to Secure Contents of Supply Compartment on Model #M-92		\$120.00

CATALOG NUMBER	DESCRIPTION	WEIGHT	PRICE
JC-2	Fixed Platform, Comes with One Canvas White Bag or Blue Vinyl Bag – Sheet Metal Silvertone Powder Coated Metal	67 lbs.	\$350.00
JC-2 SS	Above Cart in Stainless Steel	76 lbs.	\$775.00
JC-Door	Baked Enamel Door with Flush Lock to Secure Contents of Supply Compartment on Models JC-2, JC-9, JC-10		\$105.00
JCS-Door	Above Door in Stainless Steel		\$165.00
JC-HH	Mop Handle Holder Attachment for JC-2, JC-9, JC-10		\$ 45.00

### FIVE EASY WAYS TO ORDER:

1. **By Mail:** P.O. Box 190 • Syosset, NY 11791

2. **Toll-Free:** 1-800-288-3547

3. **By Fax:** 1-516-367-4714

4. **By email:** LPCORP@aol.com

5. **Through our website:** www.LatestProducts.net



# HOUSEKEEPING AND MAID CARTS

## FOLDAWAYS

Foldaway Janitorial Carts are designed for all around efficiency. The one or two bucket platforms fold up and the handle telescopes out of the way for storage.

The supply compartment has adjustable shelves for carrying supplies to the job site. Both the top tray and platforms are finished to prevent rust and corrosion.

- Manufactured from Silvertone Powder Coated Metal
- 4" Casters, 2 Fixed, 4 Swivel
- Fold-up Platform
- Optional Security of Locking Door for Supply Compartment
- Handle Telescopes for Easy Storage
- Hooks & Clips for Holding Utensils
- Epoxy Coated Tray and Platform
- Large Capacity Collection Bag



JC-10

CATALOG NUMBER	DESCRIPTION	PRICE
JC-10 72 Lbs.	Silvertone Powder Coated Folding 2 Bucket Platform White Canvas or Blue Vinyl Bag Platform Size = 33" x 18"	\$425.00
JC-10 SS 77 Lbs.	Stainless Steel Folding 2 Bucket Platform, White Canvas or Blue Vinyl Bag	795.00
JC-9 75 Lbs.	Silvertone Powder Coated Folding 1 Bucket Platform White Canvas or Blue Vinyl Bag Platform Size = 21" x 18"	395.00
JC-9 SS 80 Lbs.	Stainless Steel Folding 1 Bucket Platform, White Canvas or Blue Vinyl Bag	750.00

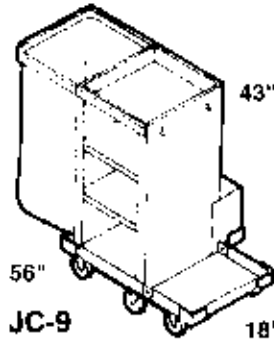

JC-9

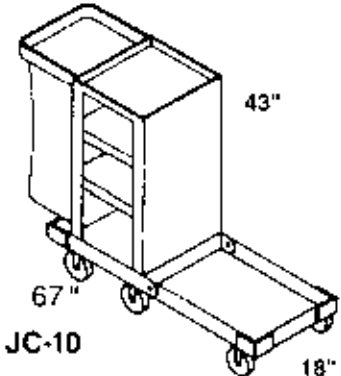

JC-10

18"

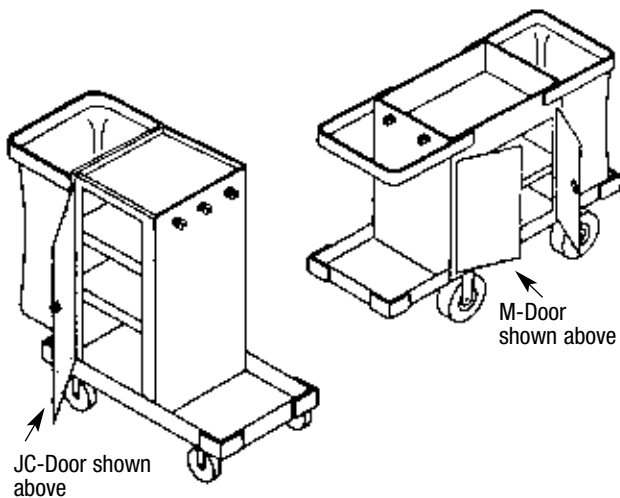

JC-Door shown above

M-Door shown above

## CART ACCESSORIES

CATALOG NUMBER	DESCRIPTION	PRICE
JC-Door	Baked Enamel Door with Flush Lock to Secure Contents of Supply Compartment on Models JC-2, JC-9, JC-10	\$105.00
JCS-Door	Above Door in Stainless Steel	165.00
M-Door	Baked Enamel Two Door Assembly with Flush Lock to Secure Contents of Supply Compartment on Model #M-92	120.00
JC-HH	Mop Handle Holder Attachment for JC-2, JC-9, JC-10	45.00

Please give us your email address so we can let you know of new products and monthly specials.



SINCE 1972, DISTRIBUTORS OF SPECIALTY ITEMS FOR HOSPITALS, NURSING HOMES, INSTITUTIONS

# LATEST PRODUCTS CORP.

P.O. Box 190 • Syosset, New York 11791 • 1-800-288-3547 • Fax 1-516-367-4714 • email LPCORP@aol.com

## HOUSEKEEPING, RECYCLING AND MAID CARTS

Ideal for Hospitals, Nursing Homes, Hotels, and Cruise Ships

### HOUSEKEEPING/MAID CART – 3 SHELVES

Model #3200 – Can easily service 15 rooms. Lightweight yet made of heavy-duty poly construction. Has three shelves (two are removable) and an interior capacity of 14.5 cubic feet. On top, a 5" deep recess top tray permits convenient handling of small or tall items. Available with rugged vinyl bags for laundry and trash (priced separately). Rounded frames protect walls and people, and 8" casters ease movement. Options available are velcro-attached **Front Cover**, **Top Cover** and detachable **Hood** which provide additional protection from spillage, pilferage, and exposure to the elements.

Also available Model #2200 with 2 shelves—deduct \$25 when ordering two shelf model #2200.



Model #3200

Bags must be ordered separately.

### MODEL #3200

Colors: Red, Royal Blue, Cadet Blue, Beige, Silver Gray, Forest Green, Jade Green, Brown, White, Black.

Casters: Specify 2 Swivel/2 Rigid or 4 Swivel.

1-3	4 or more
\$525.00	\$515.00

Soiled Linen Bags (12" x 21" x 31")  
\$30 each (Tan)

Trash Bags (12" x 21" x 17")  
\$24 each (Tan)

Available with velcro attached front cover – \$40; with top cover – \$35; top hood – \$50; corner bumpers – \$20; vacuum holder strap – \$4

Model	Capacity	Outside Dimensions			Depth	Overall Height	Casters	Shipping Weight
		L	W	Depth				
#3200	14.5 cu. ft.	56"	23"	46"	55"	8"	105 lbs.	



Model #3250

### COMPACT MAID CART

Model #3250 – Ideal for narrow hallways. The same interior and top capacity as Model #3200, this Compact Maid Cart is designed for tighter spaces with one deck and room for one heavy duty vinyl bag.

### MODEL #3250

Same colors and options as Model #3200.

1-3	4 or more
\$525.00	\$515.00

Model	Capacity	Outside Dimensions			Depth	Overall Height	Casters	Shipping Weight
		L	W	Depth				
#3250	14.5 cu. ft.	46"	23"	46"	55"	8"	103 lbs.	



Model #521-HL

### UTILITY/RECYCLING CART

Model #521-HL

**Linen and Waste Removal – Safe and Efficient** – 21 cubic foot (17 bushel) capacity with hinged lid and latch for Joint Commission guidelines. Collect waste for disposal or recycling. Hinged lid permanently in place, eases loading from one side. Order royal blue for recycling or select from other colors as shown above. Six casters – 4 corner are swivel, 2 middle rigid.

(Unit available without lid as Model #521. Deduct \$125 for Model #521.)

### MODEL #521-HL

1-3	4 or more
\$465.00	\$455.00

Model	Capacity	Outside Dimensions			Depth	Overall Height	Casters	Shipping Weight
		L	W	Depth				
#521-HL	21 cu. ft.	44"	29"	32"	39"	4"	85 lbs.	

Please put us on your bid list for all laundry and housekeeping products.

# HOSPITAL/NURSING HOME COLLECTOR CARTS

Can Be Used for Trash or Soiled Linen

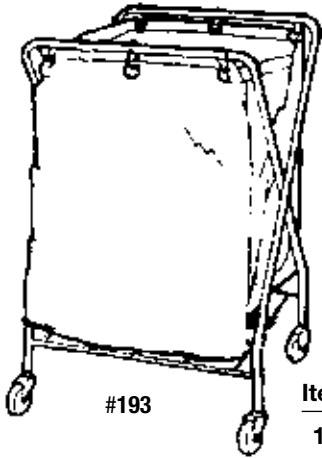

- Single bag collectors.
- Heavy chrome tubular steel frame and bottom platform for strength.
- Folds for convenient storage when not in use.
- Comes with a 6-bushel white nylon pak cloth bag or blue pak cloth bag.

Item #	Description	1	2	3+
193	Collector Truck – 24" L x 26" W x 36" H w/ 6 bu. white pak – cloth bag	\$205.00	\$195.00	\$185.00
193B	Collector Truck – 24" L x 26" W x 36" H w/ 6 bu. blue pak – cloth bag	215.00	205.00	195.00
114	White Pak – Replacement Cloth Bag – for 193 truck	65.00	63.00	61.00
115	Blue Pak – Replacement Cloth Bag – for 193 truck	65.00	63.00	61.00

# ECONOMY MOLDED JANITOR CART

## Janitor's Cart

- Manufactured from high impact structurally foamed polyethylene for strength and durability.
- Only cart that will hold a 20 or 32-gallon trash receptacle on the bottom platform; all other carts accommodate only 20-gallon receptacles.
- Specially designed hand holds for comfort and control that keeps hands out of trash.
- Adjustable center shelf.
- 8" heavy-duty wheels.
- Molded-in hooks for tools and mop handles.
- Handle folds for convenient storage.
- Non molded-in, replaceable bag hooks.
- All carts come with blue vinyl bag.
- 48" L x 20½" W x 38" H.



Item #	Description	Dimensions	Ctn. Pack	Ship Wt. Lbs./Ctn.	Price
6850	Janitor Cart – Gray, w/ 25-gallon blue vinyl bag	48" L x 20½" W x 38" H	1	36.0	\$135.00 each
6851	Blue vinyl replacement bag (25 gal. capacity)	18" L x 11" W x 27" H	1	1.5	25.00 each

Please give us your email address so we can let you know of new products and monthly specials.



SINCE 1972, DISTRIBUTORS OF SPECIALTY ITEMS FOR HOSPITALS, NURSING HOMES, INSTITUTIONS

# LATEST PRODUCTS CORP.

P.O. Box 190 • Syosset, New York 11791 • 1-800-288-3547 • Fax 1-516-367-4714 • email LPCORP@aol.com

## HOUSEKEEPING BUCKETS AND WRINGERS

Available in Plastic or Metal



Item #	Description	Capacity	Casters	Colors	Price
7y/2636-3y	#7000 plastic side press wringer/plastic bucket	26-35 quart	3"	Yellow	\$ 58.00 each
6y/2635-3y	#6000 plastic side press wringer/plastic bucket	26-35 quart	3"	Yellow, Blue, Gray	76.00 each
4y/2635-3y	#4000 plastic down pressure wringer/plastic bucket	26-35 quart	3"	Yellow, Gray	109.00 each
2000/260	#2000 metal squeeze wringer/metal bucket	26 quart	2"	Yellow	148.00 each
Pro-Y Pro-Pac	#2000 metal squeeze wringer/plastic bucket	26-35 quart	3"	Yellow	129.00 each
260	Oval galvanized steel bucket	26 quart	2"	Metal	82.00 each
WH350	Oval galvanized steel bucket	35 quart	2"	Metal	92.00 each



### 250 Mopping Tank with Two 12-1/2 Gallon Compartments

- Designed for moving large amounts of water and cleaning solution to isolated areas for big jobs.
- Constructed of heavy-duty galvanized and painted cold rolled welded steel.
- Equipped with #369 two-roller wringer with specially designed spring that easily adjusts pressure on the mop.
- Brass drain never corrodes or clogs.
- 2 compartments.
- Non-scuff vinyl bumper.

\$1,925 each. Also available with 15 or 30 gallon compartments.

Latest Products carries a complete line of janitorial and housekeeping items including mops, brooms, gloves, safety goggles, soap dispensers, electric hand dryers, wall-mounted ashtrays, sanitary napkin dispensers, and more. Please call or email us for more details.

## DUMP TILT TRUCKS



Sturdy full-perimeter black powder-coated steel underframe.

Trucks nest 3-high (2-high on heavy duty models) for lowest delivery charges.

Split hinged lids

Model No.	Truck Price in Gray*	Capacity		Outside		Inside Depth	Overall Height	Wheels (Dia. x Width, in.)		Split Hinged Lid Cat. No.	Gray*
		Cu. Yds.	Lbs.	Length	Width			Two Front	Two Rear Swivel		
P-303S	\$390.00	5/8	750	54	26	32	38	10 x 2	4 x 1 1/4	304	\$ 90.00
P-303H	525.00	5/8	1250	54	26	32	38	10 x 2	4 x 1 1/4	304	90.00
P-305S	440.00	1.1	1000	70	32	37	43	12 x 3	5 x 1 1/4	306	120.00
P-305H	575.00	1.1	2000	70	32	37	43	12 x 3	5 x 2	306	120.00
P-307S	555.00	1 1/2	1250	79 1/2	40 1/2	41 1/2	48 1/2	12 x 3	5 x 2	308	140.00
P-307H	690.00	1 1/2	2000	79 1/2	40 1/2	41 1/2	48 1/2	12 x 3	5 x 2	308	140.00

\*Other colors available at a small additional cost - please inquire.

Buy 3 or more, deduct 5% from above prices.

Note: Models with "S" are standard duty and models with "H" are heavy duty.

We offer a complete line of mops, buckets, wringers, and other housekeeping items. Please place us on your bid list.

# RECYCLING CONTAINERS & RECYCLING CARTS

## Great for Facilities Seeking “GREEN” Compliance

Latest Products Corporation offers a complete line of recycling receptacles, recycling containers and recycling carts. Our recycling products are found in hospitals, nursing homes, correctional facilities, assisted living facilities, colleges and universities, as well as for use by general industry. **Compare our prices and save!**

See Other Recycling Containers on pages 78 & 91



**Model #15RT-1H**  
\$235.00



**Model #15RT**  
\$250.00

One or Three Openings



Three Separate Plastic Liners



**Model #18RT-1H**  
\$270.00



**Model #18RT**  
\$285.00

### SMALL RECYCLING RECEPTACLE

Provides a pleasing single opening or 3-opening recycling container within a small area. Easy “lift-off” top. Choice of 3 colors. Durable all steel construction with a powder coated finish. Single opening comes with one plastic liner. Three opening comes with three 8 gallon liners. Recycling decals included. 24 gallon capacity.

### LARGE RECYCLING RECEPTACLE

Easy “lift-off” top with single opening or 3 openings for easy separation of recyclables. Single opening comes with one plastic liner. Three separate 11½ gallon plastic liners included for 3 opening container. All steel construction with a powder coated finish. Choice of 3 colors. Recycling decals included. 34½ gallon capacity.

### TALL ROUND RECYCLING CONTAINER WITH ROUND OR SLOT OPENING

Tall round recycling wastebasket & top with choice of 3” round opening or 8” slot opening. 20 gallon capacity. Blue or Black. Comes with recycle decal.

**Model #10/1DTDB (round)** \$75.00  
**Model #10/1STDB (slot)** \$85.00

Single Opening



Slot Opening



### 3 BAG RECYCLING CARTS



Three individual compartments to promote sorting of linen and clothing or recycling of plastics, glass, paper, and bottles. Equipped with three durable vinyl liners (12 or 18 bushel capacity) which are available in 6 colors, with or without the recycling logo. The liners are set within a rugged, powder-coated steel frame on a combination wood and steel base equipped with 2 swivel and 2 rigid industrial casters or 4 all swivel casters. Liners are easily removable with a Velcro system to make unloading simple. Ideal for hospitals, nursing homes, correctional facilities, hotels/motels, colleges, and general industry.

**Model #53CR** 12 bushel \$185.00  
**Model #58CR** 18 bushel \$270.00

Item #	Colors	Diameter	Height
15RT	Black	15 in	32 in
	Blue		
	Green		
18RT	Black	18 in	33 in
	Blue		
	Green		
15RT-1H	Black	15 in	32 in
	Blue		
	Green		
18RT-1H	Black	18 in	33 in
	Blue		
	Green		
10/1DTDB	Blue, Black	16 in	30in
10/1STDB	Blue, Black	16 in	30in

Item #	Colors	Height	Depth	Length	Width
53CR-12 BUSHEL	Blue	34 in	26 in	37 in	26 in
	Gray				
	Green				
	Red				
	White				
	Yellow				
58CR-18 BUSHEL	Blue	36 in	29 in	43 in	31 in
	Gray				
	Green				
	Red				
	White				
	Yellow				





SINCE 1972, DISTRIBUTORS OF SPECIALTY ITEMS FOR HOSPITALS, NURSING HOMES, INSTITUTIONS

# LATEST PRODUCTS CORP.

P.O. Box 190 • Syosset, New York 11791 • 1-800-288-3547 • Fax 1-516-367-4714 • email LPCORP@aol.com

## THE DEFENDERS® FOOT OPERATED STEP-ON CANS



Fire-safe steel with Uni-Coat® powder coated finish or #304 non-magnetic stainless steel construction. "No hands" foot pedal operation. Round models have galvanized steel liners and vinyl base rings for floor protection and reduction of noise. Square models have retainer bands that hold poly bags within the unit and are also available with a leakproof rigid plastic liner. Piano hinged lid mechanism protects walls and equipment. Steel legs feature nylon floor protectors.



COMPLIES WITH OSHA STANDARDS

ST7E Shown with optional identification labels. See page 71.

The Defenders medical step-on cans conform to OSHA standards on bloodborne pathogens for the safe containment of infectious waste and comply with OBRA Regulations. All models are UL Listed/Factory Mutual Systems Approved fire-safe/self-extinguishing and California State Fire Marshall Listed (except ST3.5 PL). All models are also manufactured of at least 30% recycled steel.

### When "Quiet" operation is crucial, Silent Defenders are the solution.

The **NEW** Quiet Close design is available on all square Defenders® Step-On Can models with the same great features, benefits and durability.



Liner Code: PL = Rigid Plastic  
GL = Galvanized Steel  
RB = Retainer Band only

Sound Damper

#### POWDER COATED MODELS—Specify Red or White

DEFENDERS				SILENT DEFENDERS		
Model No.	Description	1-3	4 +	Model No.	1-3	4 +
<b>ROUND MODELS WITH GALVANIZED STEEL LINERS</b>						
ST3.5E GL/PL	3½ Gal., 11" Dia. x 17" H	\$ 57.00	\$ 53.00	—	—	—
ST5E GL	5 Gal., 11" Dia. x 22" H	69.00	64.00	—	—	—
<b>SQUARE MODELS WITH POLYBAG RETAINER BANDS</b>						
ST7E RB	7 Gal., 12" Sq. X 17" H	91.00	84.00	QST7E RB	\$112.00	\$104.00
ST12E RB	12 Gal., 12" Sq. x 23" H	98.00	91.00	QST12E RB	120.00	112.00
ST24E RB	24 Gal., 15" Sq. x 30" H	122.00	113.00	QST24E RB	144.00	134.00
ST40E RB	40 Gal., 19" Sq. x 30" H	152.00	141.00	QST40E RB	174.00	161.00
<b>SQUARE MODEL W/ HANDLE AND WHEELS</b>						
ST40EW RB	40 Gal., 19" Sq. x 30" H	212.00	196.00	QST40EW RB	\$230.00	\$216.00
<b>SQUARE MODELS PLASTIC LINERS</b>						
ST7E PL	7 Gal., 12" Sq. X 17" H	102.00	95.00	QST7E PL	124.00	115.00
ST12E PL	12 Gal., 12" Sq. x 23" H	124.00	115.00	QST12E PL	145.00	135.00
ST24E PL	24 Gal., 15" Sq. x 30" H	149.00	138.00	QST24E PL	171.00	159.00
ST40E PL	40 Gal., 19" Sq. x 30" H	199.00	188.00	QST40E PL	222.00	206.00
<b>SQUARE MODEL W/ PLASTIC LINER - HANDLE AND WHEELS</b>						
ST40EW PL	40 Gal., 19" Sq. x 30" H	259.00	239.00	QST40EW PL	282.00	259.00

#### STAINLESS STEEL MODELS

DEFENDERS				SILENT DEFENDERS		
Model No.	Description	1-3	4 +	Model No.	1-3	4 +
<b>ROUND MODEL WITH GALVANIZED STEEL LINERS</b>						
ST3.5SS GL/PL	3½ Gal., 11" Dia. x 17" H	\$118.00	\$110.00	—	—	—
<b>SQUARE MODELS WITH POLYBAG RETAINER BANDS</b>						
ST7SS RB	7 Gal., 12" Sq. X 17" H	175.00	162.00	QST7SS RB	\$196.00	\$182.00
ST12SS RB	12 Gal., 12" Sq. x 23" H	209.00	193.00	QST12SS RB	229.00	215.00
ST24SS RB	24 Gal., 15" Sq. x 30" H	289.00	269.00	QST24SS RB	311.00	288.00
ST40SS RB	40 Gal., 19" Sq. x 30" H	409.00	384.00	QST40SS RB	439.00	408.00
<b>SQUARE MODEL W/ HANDLE AND WHEELS</b>						
ST40SW RB	40 Gal., 19" Sq. x 30" H	489.00	458.00	QST40SW RB	511.00	479.00
<b>SQUARE MODELS PLASTIC LINERS</b>						
ST7SS PL	7 Gal., 12" Sq. X 17" H	175.00	162.00	QST7SS PL	206.00	191.00
ST12SS PL	12 Gal., 12" Sq. x 23" H	229.00	217.00	QST12SS PL	256.00	235.00
ST24SS PL	24 Gal., 15" Sq. x 30" H	324.00	305.00	QST24SS PL	349.00	325.00
ST40SS PL	40 Gal., 19" Sq. x 30" H	459.00	425.00	QST40SS PL	480.00	445.00
<b>SQUARE MODEL W/ PLASTIC LINER - HANDLE AND WHEELS</b>						
ST40SW PL	40 Gal., 19" Sq. x 30" H	535.00	495.00	QST40SW PL	555.00	520.00

Please include us on all hamper and step-on can bids.

# ECONOMICAL HANDS FREE STEP-ON CANS

## MEDI-CAN™ STEEL STEP-ON CANS



The economical solution for doctor's offices and clinics. Fire-safe steel construction. Tight fitting lid for maximum odor control. Foot pedal opens self-closing lid eliminating hand contact. Plastic base ring protects floor and deadens sound. Carrying handle permits easy placement. Equipped with a galvanized steel (GL) or rigid plastic (PL) liner. Complies with OSHA standards and OBRA regulations. Models offered in your choice of red or white powder coated finishes or stainless steel.

COMPLIES WITH  
**OSHA**  
STANDARDS

Description	Liners	Dimensions	Model No.	Colors	1-3	4 +	Model No.	Color	1-3	4 +
Round 1.5 Gallon	PL	8" Dia. x 11½" H	MST1.5E	White	\$35.00	\$33.00	MST1.5SS	Stainless	\$ 60.00	\$59.00
Round 3.5 Gallon	PL	10" Dia. x 15¼" H	MST3.5E	White, Red	43.00	41.00	MST3.5SS	Stainless	76.00	76.00
Round 8 Gallon	GL	11½" Dia. x 25" H	MST7E	White	76.00	72.00	MST7SS	Stainless	118.00	115.00

Liner Code: PL = Rigid Plastic; GL = Galvanized Steel

## LABELS FOR HAMPER AND STEP-ON CAN IDENTIFICATION

Ensure proper waste disposal with these prominent bilingual labels designating the receptacle for Trash, Soiled Linen, Infectious Waste, or Biological Hazardous Material. Choose from six contents labels.



**BP-1** (red background)



**CD-1** (yellow background)



**CL-1**



**CL-2**



**CL-3**



**CL-4**

- |      |                                    |                                 |
|------|------------------------------------|---------------------------------|
| CD-1 | Chemotherapy Waste                 | (6" Square - Black/Yellow)      |
| BP-1 | Bio-Hazard                         | (6" Square - Black/Red)         |
| CL-1 | Bio-Hazard/Peligro Biologico       | (7" H x 10" W - Black on White) |
| CL-2 | Soiled Linen/Ropa Sucia            | (4" H x 10" W - Black on White) |
| CL-3 | Trash Only/Basura Solamente        | (4" H x 10" W - Black on White) |
| CL-4 | Infectious Waste/Basura Infecciosa | (4" H x 10" W - Black on White) |

If ordered with cans  
**\$3.25** each  
If ordered without can order  
**\$5.00** each  
Minimum purchase is 12 labels

**TERMS: 2% ten days, net 30, F.O.B. Factory. We prepay shipping and add to invoice.**



SINCE 1972, DISTRIBUTORS OF SPECIALTY ITEMS FOR HOSPITALS, NURSING HOMES, INSTITUTIONS

# LATEST PRODUCTS CORP.

P.O. Box 190 • Syosset, New York 11791 • 1-800-288-3547 • Fax 1-516-367-4714 • email LPCORP@aol.com

## PLASTIC RECEPTACLES AND ACCESSORIES

### Gator Container & Accessories

- Gator containers meet and surpass all other heavy duty plastic containers in every category.
- Molded with highest quality polyethylene resin.
- One piece molded construction creates high impact and crush resistance.
- With its lock down lid, the container is animal and spill resistant, lid stays on even if container is tipped over.
- Offset ridge design allows container to nest without jamming.
- Gator handles have a larger radius and deeper well, making the container more comfortable to lift and move.
- Colors as indicated.



7744 w/7745  
Container with lid

7732 w/7733  
Container with lid

7720 w/7721  
Container with lid

7710 w/7711  
Container with lid

### Gator Caddy

- Water resistant.
- Caddy aprons around container.
- Nine pouches for cleaning supplies.
- Fits 32 and 44 gallon containers.



### Gator Dolly

- Structural foam molded, extremely durable.
- Five 3" swivel casters, extremely stable.
- Securely attaches to 20, 32, 44, and 55 gallon Gators.
- Gator dolly fits competitors' containers.
- Only dolly with vents to keep from suctioning to container.



7704 Dolly

### Thin Bin

High capacity container designed for tight places.

- 23 gal. capacity.
- Convenient ergonomic designed handles.
- Recessed hand grips molded into bottom for easy emptying.
- Textured finish outside for attractive, commercial look.
- Smooth inside surface for easy cleaning.
- Constructed of durable polyethylene blend.



7023 Thin Bin  
Container



7705 Caddy

Item #	Description	Dimensions	Color	Ctn. Pack	Ship. Wt. Lbs./Ctn.	Price Each
7710	10-gallon, Gator container	15 7/8" Dia. x 17" H	White, Gray	6	16.0	\$18.00
7711	10-gallon, Gator lid	16" Dia. x 1 3/16" H	White, Gray	6	5.5	7.50
7720	20-gallon, Gator container	19 1/4" Dia. x 23 1/8" H	Gray, White, Blue, Red	6	36.0	29.00
7721	20-gallon, Gator lid	19 1/2" Dia. x 1 1/8" H	Gray, White, Blue, Red	6	9.1	8.00
7732*	32-gallon, Gator container	21 3/4" Dia. x 27 3/8" H	Gray, Yellow, White, Blue, Green	6	56.0	39.00
7733	32-gallon, Gator lid	22" Dia. x 1 1/4" H	Gray, Yellow, White, Blue, Green	6	12.0	11.50
7744	44-gallon, Gator container	23 3/4" Dia. x 31 5/8" H	Gray, Yellow, White, Blue, Red	4	53.0	56.00
7745	44-gallon, Gator lid	24" Dia. x 1 3/8" H	Gray, Yellow, White, Blue, Red	4	11.0	20.25
7755	55-gallon, Gator container	26 3/4" Dia. x 33" H	Gray	3	52.0	89.00
7756	55-gallon, Gator lid	27 1/4" Dia. x 2 1/2" H	Gray	3	12.75	30.00
7705	Caddy, fits 32 & 44-gallon Gators	20" Dia. x 20 1/2" H	Yellow	6	7.8	35.00
7704	Dolly	17 7/8" Dia. x 6 9/16" H	Black	2	15.0	43.00
7708	Anchor no-tilt dolly	24" Dia. x 7" H	Black	2	17.0	47.00
7023*	23-gallon, thin bin container	11" L x 23" W x 30" H	Beige, Gray, Brown, Blue	4	28.0	50.00
7024	23-gallon, thin bin lid	20 1/4" L x 11 3/16" W x 4 1/2" H	Beige, Gray, Brown	4	10.4	31.00

\*7732 and 7023 available with imprinted recycle logo, add \$2.00 per receptacle.

**Minimum receptacle and accessory order for these items – \$100.  
No broken cartons please.**

**We offer a complete line of mops, buckets, wringers, and other housekeeping items. Please place us on your bid list.**

# DECORATIVE RECEPTACLES

## HALF ROUND RECEPTACLES

Space saving semicircular flat top and open top receptacles are an elegant alternative to traditional receptacles when aesthetics are important and space is limited. Fire-safe steel construction with bottom rim designed to protect floors. Protective vinyl trim on all openings. Leakproof rigid plastic liner. Lift-off body facilitates easy emptying. Available in Satin Stainless Steel (SSS) and Black with Chrome accents (20B). Manufactured using 30% recycled steel.



Model No.	Dimensions	Capacity	Price Each	
			1-5	6 or more
<b>SO12SSS</b>	32" H x 18" W x 9" D	12 gal.	\$280.00	\$275.00
<b>SO1220B</b>	32" H x 18" W x 9" D	12 gal.	160.00	155.00
<b>SO8SSS</b>	32" H x 15" W x 9" D	9 gal.	235.00	230.00
<b>SO820B</b>	32" H x 15" W x 9" D	9 gal.	138.00	133.00

SC18SMPL

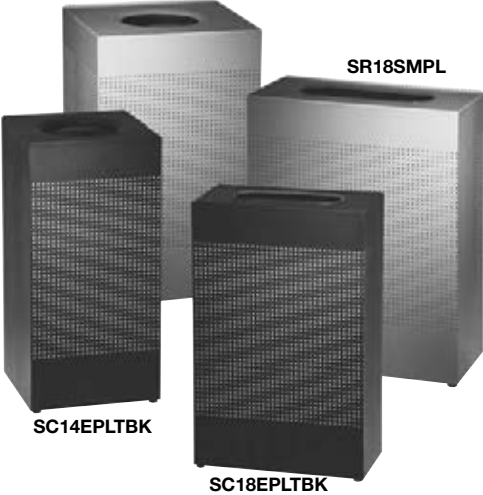

## SILHOUETTES

Heavy gauge steel construction and graphic perforations combine to create a sleek, modern, fire-safe design. Durable Silver Metallic (SM) powder coated finish offers the look of stainless steel and resists fingerprints, also available in Textured Black (TBK). Folding retainer bands secure poly bag out of sight. Convenient hinged top for easy emptying. Leg levelers provide stable placement. Leakproof rigid plastic liner. Manufactured using 30% recycled steel.

Model No.	Dimensions	Capacity	Price Each	
			1-5	6 or more
<b>SC14SMPL</b>	30" H X 14.75" W X 14.75" D	16 gal.	\$285.00	\$275.00
<b>SC18SMPL</b>	30" H X 18.75" W X 18.5" D	29 gal.	365.00	355.00
<b>SR14SMPL</b>	30" H X 19.5" W X 10" D	13 gal.	305.00	295.00
<b>SR18SMPL</b>	30" H X 24" W X 12.5" D	22.5 gal.	395.00	385.00
<b>SC14EPLTBK</b>	30" H X 14.75" W X 14.75" D	16 gal.	260.00	250.00
<b>SC18EPLTBK</b>	30" H X 18.75" W X 18.75" D	29 gal.	335.00	325.00
<b>SR14EPLTBK</b>	30" H X 19.5" W X 10" D	13 gal.	275.00	265.00
<b>SR18EPLTBK</b>	30" H X 24" W X 12.5" D	22.5 gal.	360.00	350.00

## ECLIPSE

Sleek smooth curves and gleaming finishes in heavy gauge fire-safe steel or non-magnetic stainless steel. Large 30 gallon capacity with an open top design for "hands-free" drop in convenience in high traffic areas. Curved top deters accumulation of debris around 9.5" x 11.5" disposal opening. Top lifts off for easy emptying of leakproof rigid plastic liner. Recessed base ring allows for ease in cleaning under unit. Standard models are available with durable Black Uni-Koat powder coated finish or Satin Stainless Steel. Customize with decals or transfers or choose from over 180 custom colors. 2 year limited warranty.

Model No.	Color	Price Each	
		1-5	6 or more
<b>R2030E</b>	Black	\$295.00	\$285.00
<b>R2030SS</b>	Stainless Steel	515.00	495.00



Our decorative receptacles are found in the entrances, lobbies and hallways of hospitals, nursing homes and office buildings.



SINCE 1972, DISTRIBUTORS OF SPECIALTY ITEMS FOR HOSPITALS, NURSING HOMES, INSTITUTIONS

# LATEST PRODUCTS CORP.

P.O. Box 190 • Syosset, New York 11791 • 1-800-288-3547 • Fax 1-516-367-4714 • email LPCORP@aol.com

## OUTDOOR RECEPTACLES

### Used at thousands of facilities nationwide

- Durable powder coated, hot-dipped galvanized steel construction withstands the elements.
- Leakproof rigid plastic liners make maintenance a snap.
- Available in UV Stabilized Standard black powder coated finish.
- ADA compliant.
- Model R36HTSBK is equipped with adjustable leg levelers for stability on uneven surfaces.
- Manufactured using 30% recycled steel.

Model No.	Dimensions	Capacity	Price Each	
			1-4	5 or more
R12SBK	13.5" Sq. x 32" H	12 gal.	\$180.00	\$170.00
R36HTSBK	21" Sq. x 40" H	29 gal.	495.00	470.00

Other styles and sizes available. Please inquire.



### AMERICANA SERIES™

- The Americana Series is made from rugged steel with multiple layers of powder coating to ensure years of trouble free, outdoor use.
- UV stabilized to resist fading.
- Waste receptacles have removable leakproof rigid plastic liner.
- Four leg levelers permit placement on uneven surfaces.
- All models are cable secured and lift-off for easy emptying.
- Available in Black, Architectural Bronze and Green. Please specify.
- Extremely heavy, to deter theft and withstand harsh weather conditions.
- Manufactured using 30% recycled steel.

Model No.	Description	Dimensions	Capacity	Price Each	
				1-4	5 or more
MT22	Receptacle	25.5" Dia. x 25.5" H	24 gal.	\$650.00	\$625.00
MT32	Receptacle	29" Dia. x 32.5" H	36 gal.	805.00	780.00
MT12	Sand Urn	17" Dia. x 25.5" H	—	530.00	505.00

### HOWARD CLASSICS™

- Fire-safe, heavy gauge, hot dipped galvanized steel construction.
- Clean, modern perforated steel design.
- Adjustable leg levelers hold receptacle off ground and provide stability.
- UV Stabilized Standard black powder coated finish with white leakproof rigid plastic liner.
- Manufactured using 30% recycled steel.

Model No.	Dimensions	Capacity	Price Each	
			1-4	5 or more
S3ETBK	18" Dia. x 35.5" H	25 gal.	\$330.00	\$305.00
S55ETBK	25" Dia. x 35.5" H	51 gal.	490.00	465.00

Available in Black Only



TERMS: 2% ten days, net 30, F.O.B. Factory. We prepay shipping and add to invoice.



# INDOOR RECEPTACLES

## STEEL ROUND TOP RECEPTACLES

**Manufactured using 30% recycled steel.**



Models **B, C** and **D** are UL Listed and FM Approved Fire Safe/Self-Extinguishing. Model **A** features hands-free foot pedal operation. All models have a self-closing reinforced push door to control odors and comply with OSHA Standards. Recessed hand grips permit easy lift-off for emptying. Non-corrosive base ring protects floors. Complete with 15 gallon galvanized steel liner. Powder coated finishes or metallic finished steel. 15" Dia. x 36" H.

**Color Codes:** **AL** - Almond, **BK** - Black, **CB** - Cobalt Blue, **RD** - Red, **SG** - Spruce Green, **WH** - White

	Model No.	Finish	Price Each	
			1-4	5 or more
A	<b>R1536STEGL</b>	White	\$180.00	\$175.00
	<b>R1536STEMGL</b> (not shown)	Silver Metallic	235.00	230.00
B	<b>R1536BSBGL</b>	Satin Brass Stainless	240.00	235.00
	<b>R1536SSSGL</b> (not shown)	Satin Stainless	235.00	230.00
C	<b>R1536MCGL</b>	Mirror Chrome	300.00	295.00
D	<b>R1536EGL</b>	AL, BK, CB, RD, SG, WH	135.00	130.00
	<b>R1536SMGL</b> (not shown)	Silver Metallic	190.00	185.00

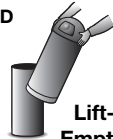

Lift-off Emptying

All models manufactured using 30% recycled steel.

**Used at thousands of facilities nationwide.**

## HANDS FREE OPEN TOPS

All cans feature heavy gauge fire-safe steel construction, non-corrosive base ring to protect floors and recessed hand grips to permit easy lift-off for emptying. Open top design is perfect for high traffic areas or where a touchless environment is desired. 15 gallon capacity. Model A is UL Listed/FM Approved fire-safe and self-extinguishing.



	Model No.	Dimensions	Finish	Price Each	
				1-4	5 or more
A	<b>R32EWH</b>	15" Dia. x 32" H	White	\$120.00	\$115.00
	<b>R32EBK</b>	15" Dia. x 32" H	Black	120.00	115.00
B	<b>R1536EOT</b>	15" Dia. x 35.5" H	Black	125.00	120.00

Manufactured using 30% recycled steel.

## WASTEMASTER RECEPTACLES

Fire-safe steel construction with a white Uni-Koat® powder coated finish. Models **A** and **B** are UL Listed and FM Approved Fire-Safe/Self-Extinguishing. Retainer bands hold poly bags securely within the leakproof rigid plastic liner. Attached hinged top with springless, self-closing dual entry door.

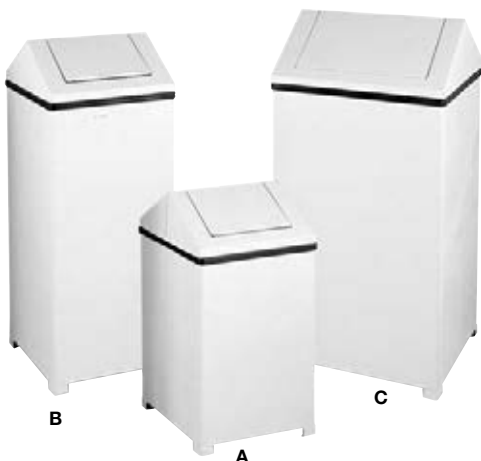

	Model No.	Dimensions	Capacity with Liner	Price Each	
				1-4	5 or more
A	<b>T1414EPL</b>	14" Sq. x 26" H	10.5 gal.	\$170.00	\$165.00
B	<b>T1424EPL</b>	14" Sq. x 35.5" H	16 gal.	190.00	185.00
C	<b>T1940EPL</b>	19" Sq. x 38" H	29 gal.	235.00	230.00

Manufactured using 30% recycled steel.

Deduct \$15 per unit if no liner required.

Stainless steel models also available. Please inquire.

Please include us on all receptacle and step-on can bids.



SINCE 1972, DISTRIBUTORS OF SPECIALTY ITEMS FOR HOSPITALS, NURSING HOMES, INSTITUTIONS

# LATEST PRODUCTS CORP.

P.O. Box 190 • Syosset, New York 11791 • 1-800-288-3547 • Fax 1-516-367-4714 • email LPCORP@aol.com

## WASTEBASKETS

### STEEL WASTEBASKETS

UL Classified fire-safe. Puncture resistant steel construction with durable powder coated finishes. Round model has rolled wire rims, embossed panels and double-locked seams. Rectangular basket has a vinyl rim cushion and nylon buttons on legs. 1" recessed bottom on both models prevents heat transfer to floors. Manufactured using 30% recycled steel.

Model No.	Dimensions	Capacity	Price Each	
			3	6 or more
<b>WB26</b>	13½" Dia. x 14½" H	26 qt.	N/A	\$14.00
<b>WB44</b>	15¾" Dia. x 18" H	44 qt.	\$22.00	20.00
<b>WB2029</b>	16" Dia. x 29" H	80 qt.	36.00	34.00
<b>WB30R</b>	17" W x 15" H x 8" D	30 qt.	32.00	30.00
<b>WB96R</b>	21" W x 30" H x 11" D	96 qt.	65.00	61.00

Wastebaskets must be purchased in carton quantities.

WB26 – 6/carton, all other models are 3/carton.

All above models meet federal specification A-A-182 for fire hazard and flammability prevention.



Colors Available: Almond, Black, Gray

### CONCEPT COLLECTION



Steel mesh designs feature an attractive diamond pattern, sturdy steel construction and solid steel bases. Epoxy finish with no-snap curled rim to protect clothing and furniture. ADA Compliant. Manufactured using 30% recycled steel.

Model No.	Dimensions	Capacity	Color	Price Each	
				3	6 or more
<b>WMB20BK</b>	11.5" Dia. x 14" H	5 Gal.	Black	—	\$15.00
<b>WMB20SL</b>	11.5" Dia. x 14" H	5 Gal.	Silver	—	15.00
<b>WMB30R</b>	16" W x 14" H x 8.5" D	7.5 Gal.	Black	\$21.00	20.00

Wastebaskets must be purchased in carton quantities.

WMB20 - 6/carton, WMB30R - 3/carton.

### HIDE-A-BAGS

Innovative two part design conceals poly bag for a neat appearance. Unique lift-off outer sleeve and 3.5 gallon inner container is constructed of fireproof steel. Available in durable black powder coated finish with decorative stainless steel trim or all satin stainless steel. Non-corrosive vinyl base ring protects floors. 9½" Dia. x 12½" H.



Neatly conceals polybag

Model No.	Color	Capacity	Price Each	
			1-5	6 or more
<b>WHB14BK</b>	Black/Stainless	3.5 Gal.	\$40.00	\$38.00
<b>WHB14SS</b>	Stainless Steel	3.5 Gal.	55.00	53.00



WHB14SS

WHB14BK

#### FIVE EASY WAYS TO ORDER:

1. **By Mail:** P.O. Box 190 • Syosset, NY 11791

2. **Toll-Free:** 1-800-288-3547

3. **By Fax:** 1-516-367-4714

4. **By email:** LPCORP@aol.com

5. **Through our website:** [www.LatestProducts.net](http://www.LatestProducts.net)

# SMOKERS' SOLUTIONS

To keep your facility clean



R1639E

Shown outdoors in use.



## ALADDIN

Factory mutual approved, oxygen restricting self-extinguishing fluted design. Fire-safe steel construction with a hammertone powder coated finish. Top is secured with a hidden chain to prevent theft and is fastened from the base with two easily operated latches for easy emptying. 4¼ gallon galvanized steel liner. 16" Dia. x 39" H. Manufactured using 30% recycled steel.

Specify Bronze or Charcoal

## SMOKERS' POLE

The simple space saving solution to control smokers' waste. Unique two part ergonomic design reduces back strain and requires no tools for fast, easy maintenance. Durable, weather resistant powder coated aluminum construction. Two 3½" W x 1" H disposal openings with recessed extinguishing screen.

4" Dia. x 41" H (14¼" Dia. Base)

Specify Black or Silver Metallic



R1

Smokers' Pole

## Smokers' Stations® Wall Mounted Model

Attractive, fire-safe and weather resistant means to keep smoking waste under control. Galvanized steel body with black textured powder coated finish and stainless steel door. Two disposal openings with recessed stainless steel extinguishing screen and galvanized liner provide safe disposal of cigarette butts. Mounting hardware is included. 10" W x 3" D x 12½" H. Manufactured using 30% recycled steel.



R1012E

Model No.	Description	Price Each	
		1-5	6 or more
R1012E	Wall Mounted	\$102.00	\$ 99.00
R1639E	Aladdin	124.00	122.00
R1	Smokers' Pole	135.00	126.00



R12SU

R18SU

R40SU

R41WU

### Specify Colors:

Gray with dove gray panels

Brown with desert brown panels

Other colors available. Please inquire.

## Sand Top and Weather Urn Ash/Trash Receptacles

Designed for use indoors or out. Heavy gauge, galvanized, fire-safe steel for maximum corrosion resistance. UV stabilized powder coated finish provides long lasting color protection. Natural stone panels are backed by steel, have a Class A fire rating and a 15 year limited warranty. One piece large capacity sand tops for reduced maintenance. Weather Urns feature a removable hinged top which conceals smokers' waste and shields contents from weather for neat, easy emptying. Rigid plastic liners included. Manufactured using 30% recycled steel.



Weather Urn

Model No.	Description	Capacity	Dimensions Sq. x H.	Price Each	
				1-5	6 or more
R12SU	Sand Top/Trash	12 Gal.	13½" x 32"	\$365.00	\$355.00
R12WU	Weather Urn/Trash	12 Gal.	13½" x 35"	395.00	385.00
R41	Sand Top/Trash	2.5 Gal.	10" x 24"	210.00	200.00
R41WU	Weather Urn/Trash	2.5 Gal.	10" x 27"	270.00	260.00
R18SU	Sand Top/Trash	24 Gal.	18" x 32"	425.00	415.00
R18WU	Weather Urn/Trash	24 Gal.	18" x 35"	470.00	460.00
R40SU	Sand Top	‡	10" x 24"	160.00	150.00
R40WU	Weather Urn	‡	10" x 27"	215.00	205.00

‡ Not a trash receptacle.

Specify Gray or Brown when ordering.

Urn Sand available. Please inquire.

**TERMS: 2% ten days, net 30, F.O.B. Factory. We prepay shipping and add to invoice.**



SINCE 1972, DISTRIBUTORS OF SPECIALTY ITEMS FOR HOSPITALS, NURSING HOMES, INSTITUTIONS

# LATEST PRODUCTS CORP.

P.O. Box 190 • Syosset, New York 11791 • 1-800-288-3547 • Fax 1-516-367-4714 • email LPCORP@aol.com

## RECYCLING CONTAINERS

### SILHOUETTE RECYCLING CONTAINERS

An attractive solution for recycling. Constructed of heavy gauge, fire-safe steel in your choice of Textured Black (TBK), Silver Metallic (SM) or Desert Pearl (DP) Uni-Koat powder coated finishes or satin finished Stainless Steel (SS). Round models feature lift-off tops and a 26 gallon capacity. Square models feature piano hinged tops for easy emptying and a 29 gallon capacity. Choose from three item specific openings with protective vinyl trim to meet your unique recycling needs. All models come complete with a leakproof rigid plastic liner, retainer bands to hold polybags and adjustable leg levelers to provide stability on uneven surfaces.

#### Square Recycling Container

Description	Model No.	Finish	Price Each	Model No.	Finish	Price Each
Can Opening	DCR24C	TBK, SM, DP	\$405.00	DCR24C	SS	\$625.00
Paper Opening	DCR24P	TBK, SM, DP	405.00	DCR24P	SS	625.00
Trash Opening	DCR24T	TBK, SM, DP	405.00	DCR24T	SS	625.00

#### Round Recycling Container

Description	Model No.	Finish	Price Each	Model No.	Finish	Price Each
Can Opening	DRR24C	TBK, SM, DP	\$370.00	DRR24C	SS	\$540.00
Paper Opening	DRR24P	TBK, SM, DP	370.00	DRR24P	SS	540.00
Trash Opening	DRR24T	TBK, SM, DP	370.00	DRR24T	SS	540.00



Buy 4 or More  
Take 5% Off

See Other Recycling Containers on pages 69 & 91

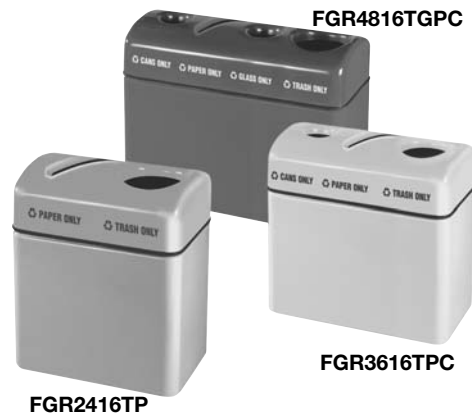

### FIBERGLASS RECYCLING CONTAINERS

Receptacles tailored to your specific waste and recycling needs. Curved top prevents placement of objects on top of receptacles. Item specific disposal openings accommodate only appropriate waste materials. Flat top models, custom disposal opening and additional decals are available. Leakproof rigid plastic liner. Model FGR4816TGPC includes a galvanized liner. Decals included.

Model No.	Description	Dimensions	Capacity	Price Each
FGR4816TGPC*	4 section	48" W x 28" H x 15" D	two 9 and two 16 gal. sections	\$1,405.00
FGR3616TPC*	3 section	36" W x 28" H x 15" D	16 gal./section	970.00
FGR2416TP*	2 section	24" W x 28" H x 15" D	16 gal./section	675.00

\*31 colors available. Call for details.

### CLASSIC STAINLESS STEEL RECYCLING CONTAINERS

The classic look and contrasting appeal of durable, powder coated black tops and sleek perforated stainless steel makes recycling easy. The cable secured tops are manufactured with a customized opening, optional recycling decals clearly indicate the specific use. The rust proof stainless steel bodies are virtually weatherproof and include leakproof rigid plastic liners as well as adjustable leg levelers for stability on uneven surfaces. Optional anchoring kits available. Decals included.

Model No.	Description	Dimensions	Capacity	Price Each
S3SSPBKPL	Paper opening	18" Dia. x 35.5" H	25 gal.	\$525.00
S3SSGBKPL	Cans/glass opening	18" Dia. x 35.5" H	25 gal.	525.00
S3SSTBKPL	Trash opening	18" Dia. x 35.5" H	25 gal.	525.00
S55SSTBKPL	Trash opening	36" Dia. x 35.5" H	51 gal.	665.00



TERMS: 2% ten days, net 30, F.O.B. Factory. We prepay shipping and add to invoice.



# PATIENT PRIVACY SCREENS

Durable, Attractive & Competitively Priced



69" Tall with Casters  
67" Tall without Casters

## STANDARD PRIVACY SCREEN WITH OR WITHOUT CASTERS

Flame-retardant vinyl panels (choice of white, blue, green or pink) wash easily. White powder coated steel frames available with 2" twin wheel casters for portability, measure 27" x 55" per panel and 17½" from floor to bottom of screen.

<b>PSS-3</b>	Best Quality Screens – without Casters	\$110 each
<b>PSS-3C</b>	Best Quality Screens – with Casters	\$120 each

Vinyl screening meets minimum requirements of flame resistance of CA fire marshal for products identified in section 13115, CA health and safety code, and NFPA# 701.

**New Colors Now Available!**



## TELESCOPING CURTAINS

Pull rod-hung curtains out to a full 90" from wall, push back to an out-of-the-way 51" or flat against wall. Flame-retardant, white, blue, green or pink vinyl curtain is 72" high. Kit includes wall bracket, telescoping rod, curtain and hooks.

<b>PST</b>	Complete Kit	\$100
------------	--------------	-------

# PATIENT ROOM TABLES

ONE LOW PRICE — Order as many as you want at sharply discounted prices



**\$95 each (delivery additional)**

**Convenient Tilt-Top Feature for Easy Reading and Writing NOW AVAILABLE Please Inquire!**



**\$112 each (delivery additional)**

## LOW OVERBED TABLE—ADJUSTABLE

Model # 11640 – Walnut grain laminate top  
**\$95.00 each.**

### Specifications

Height Range:	17½" - 25½", glides 19¾" - 26¾", casters
Table Size:	15" x 30"
Table Top Material:	Laminate
Table Capacity:	50 lbs.
Ground Clearance:	1⅞", glides 3⅞", casters (2 are locking)
Frame:	Chrome Frame H-Base
Weight:	20 lbs.

## OVERBED TABLE—ADJUSTABLE

Model # 11610 – Walnut grain laminate top  
Model # 11600 – Gray laminate top  
**\$112.00 each.**

- Laminate top with vinyl trim
- Chrome base
- Easy spring loaded height adjustment
- Four point H-base with two locking dual wheel nylon casters
- Height 28" to 43" (18" higher than low table)
- Base 15½" x 26½"
- Top 15" x 30"
- Weight: 30 lbs.
- Table capacity 50 lbs.
- Some assembly required

Please place us on your bid list for all laundry and housekeeping products.





SINCE 1972, DISTRIBUTORS OF SPECIALTY ITEMS FOR HOSPITALS, NURSING HOMES, INSTITUTIONS

# LATEST PRODUCTS CORP.

P.O. Box 190 • Syosset, New York 11791 • 1-800-288-3547 • Fax 1-516-367-4714 • email LPCORP@aol.com

**MANY  
PRICES  
REDUCED**

## INDUSTRIAL LAUNDRY BASKET SCALES AND ROLLING SCALES



**Easy  
reading dial.**

### HEAVY GAUGE POLY BASKET SCALE

Removable Basket.  
Cleans easily.  
19½" x 18½" x 33½" – 4 bushel.  
Has hand rails for moving across floors.  
35" to top of basket.  
35" to top of arm.  
37" wide x 20" deep.  
56 lb. weight.  
Ships UPS knocked down.

4 Bushel – Stock No. **S53** (60 lb. capacity) **\$419.00**  
6 Bushel – Stock No. **S54** (85 lb. capacity) **\$450.00**



Now also available with  
spring platform.

### NO. S70 SCALE

10 bushel. 200 lb. capacity  
scale in 1 lb. increments.  
Heavy all steel frame. Heavy  
duty nylon basket.  
4 in. ball bearing casters for  
easy rolling.  
Basket is 25" W x 35" L  
x 25" D  
Overall dimensions including  
top bar 30" W x 43½" L  
x 51½" H.  
Note: Scale head can only  
be used with basket.  
Shipping wt. 65 lbs.

**#S70** **\$585.00**  
**#S70SP** **\$645.00** with spring platform



### DIAL SCALE BY DETECTO

100 lbs. capacity in ½ lb. increments.  
Overall height 36". Comes with oversize  
Double Lip Plate (lip back and front)  
plate size is 18" x 18", 7" x 5" lips.

**#48100-36** **\$735.00**



Now also available with  
spring platform.

### NO. 70PL SCALE

10 bushel basket. 200 lb. capacity scale head.  
All steel frame. Heavy gauge poly basket that's  
easy to clean. 4 in. ball bearing casters.  
Basket is 22" W x 34" L x 25" D.  
Overall dimensions including top bar  
30" W x 43½" L x 51½" H.  
Note: Scale head can only be used with basket.  
Shipping wt. 95 lbs.

**#70PL** **\$715.00**  
**#70PLSP** **\$780.00** with spring platform



### NO. S40 WIRE BASKET SCALE

For Coin-Op Applications. Basket size  
26" x 18" x 10". 40 lbs. capacity in 2  
ounce increments. Overall height is  
20¼". Pound and Metric dial. Ships  
UPS 30 lbs.

**No. S40** **\$199.00**



### SCALE CART - 3" SWIVEL CASTERS

Easy to use, easy to roll, accurate laundry scale cart.  
Removable one piece gray polyethylene tub.  
Sturdy chrome steel frame.  
3" all swivel casters.  
Heavy duty industrial scale.  
4 Bushel - 33" x 19" x 29" for 200-240 lb. loads.  
6 Bushel - 33" x 23" x 33" for 200-260 lb. loads.  
Ships UPS.

**#MSC411** 4 bu 33" x 19" x 29" **\$430.00**  
**#MSC461** 6 bu 33" x 23" x 33" **\$465.00**



### NO. S11 SCALE

Capacity 50 lbs. in .05 lb. increments. Bright digital  
readout, low battery indicator light. Shuts off  
automatically after 7 minutes. Long, long battery  
life. Overload/underload display. ABS shatterproof  
housing with splash proof display. Basket  
measures 25½" x 25½" x 11½". Overall height is  
20". Ships UPS 30 lbs.

**No. S11** **\$425.00**

See our website for new Portable Wheelchair Scales just introduced!

# ROLLING GARMENT AND COAT RACKS

## HEAVY DUTY CONSTRUCTION - DURABLE EASY-ROLLING BASE

Base is painted - Uprights and Hanger 14 gauge plated steel with 4" ball bearing swivel wheel casters with cushion tread.

Racks are shipped knocked down. Easily assembled.

**IMPORTANT: All units can be shipped by UPS except 1335-72 and 1333-72 which must be shipped common carrier.**

**See our website for new nestable garment racks!**

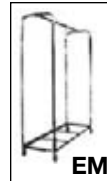
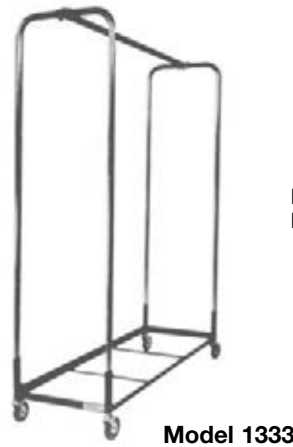
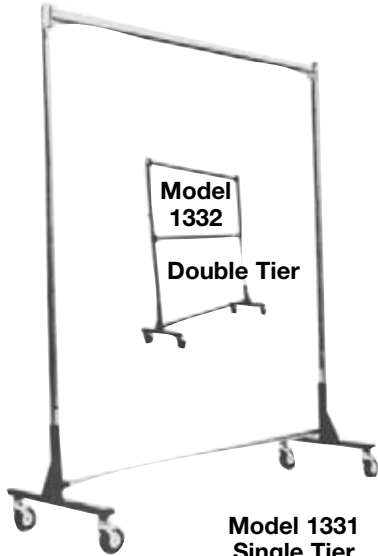

Bottom Shelf with breathing holes

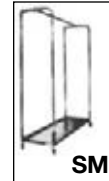

Solid Bottom Shelf



### Garment Rack, Heavy Duty, Adjustable Height, Single Tier

No.	Width	Length	Maximum Height	Weight	Price
1331-36	20"	36"	72"	30 lbs.	\$125.00
1331-48	20"	48"	72"	32 lbs.	135.00
1331-60	20"	60"	72"	34 lbs.	140.00
1331-72	20"	72"	72"	36 lbs.	145.00

For 5" Casters add \$30.00  
For 5" Rubber Corner Bumpers add \$25.00

### Garment Rack, Heavy Duty, Adjustable Height, Double Tier

No.	Width	Length	Maximum Height	Weight	Price
1332-36	20"	36"	78"	34 lbs.	\$145.00
1332-48	20"	48"	78"	36 lbs.	155.00
1332-60	20"	60"	78"	38 lbs.	165.00
1332-72	20"	72"	78"	40 lbs.	175.00

For 5" Casters add \$30.00  
For 5" Rubber Corner Bumpers add \$25.00

### Garment Rack, Heavy Duty, Single Top Bar

No.	Width	Length	Height	Weight	Price	With Bottom Shelf**
1333-48	20"	48"	72"	68 lbs.	\$215.00	\$260.00
1333-60	20"	60"	72"	72 lbs.	220.00	290.00
1333-72	20"	72"	72"	76 lbs.	235.00	305.00

For 5" Casters add \$60.00  
For 5" Rubber Corner Bumpers add \$55.00

### Garment Rack, Heavy Duty, Double Top Bar

No.	Width	Length	Height	Weight	Price	With Bottom Shelf**
1335-48	28"	48"	72"	70 lbs.	\$240.00	\$305.00
1335-60	28"	60"	72"	74 lbs.	245.00	320.00
1335-72	28"	72"	72"	78 lbs.	255.00	335.00

For 5" Casters add \$60.00  
For 5" Rubber Corner Bumpers add \$55.00

\*\*Shelf: Specify SM for Solid Metal or Specify EM for Shelf with Breathing Holes

Used in hospitals to move garments such as lab coats, and in nursing homes for admission or discharge of patients.



SINCE 1972, DISTRIBUTORS OF SPECIALTY ITEMS FOR HOSPITALS, NURSING HOMES, INSTITUTIONS

# LATEST PRODUCTS CORP.

P.O. Box 190 • Syosset, New York 11791 • 1-800-288-3547 • Fax 1-516-367-4714 • email LPCORP@aol.com

## SAFETY PRODUCTS

AT LOW, LOW DISCOUNTED PRICES

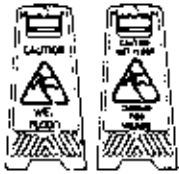

### WET FLOOR SIGNS

Description	Item #	Color
Caution – Wet Floor/Cuidado – Piso Mojado	9152W	Yellow
Caution – Wet Floor (English only)	9152E	Yellow
Caution – Wet Floor/Cuidado – Piso Mojado	9153W	Pink

Packed 6 per case (no broken cases) – 11" W x 24" H x 1" Thick

ONE LOW PRICE –  
Order as many as you  
want **ONLY \$84/Case**  
(\$14.00/each)  
Packed 6 per case

### FLOOR SIGNS WITH SIDE BAR – 25" High

**\$102/Case (\$17.00/each)**  
Packed 6 per case

Description	Item #	Color
Caution – Wet Floor/Cuidado – Piso Mojado	24106	Yellow
No Entry/Restroom Closed	24109	Yellow

Packed 6 per case (no broken cases)



Top Flashing Light



### 4 SIDED FLOOR SIGNS Available with or without Top Flashing Light

Description	25" H	36" H	Color
Plain	—	23888	Yellow
Caution	—	23887	Yellow
Danger – People Working Above	—	23834	Yellow
Caution – Wet Floor	23812	23870	Yellow
Caution – Wet Floor/Cuidado – Piso Mojado	23816	23879	Yellow
Caution – Wet Floor/Cuidado – Piso Mojado	—	24236	Fluorescent Green
Caution – Safety First/Cuidado – Seguridad	—	23868	Yellow
Wet Floor/Cuidado	23817	—	Yellow

Packed 5 per case (no broken cases). Top flashing light is available as an option for \$25 per sign and requires two AA batteries (not included).

ONE LOW PRICE –  
**25" ONLY \$114/case of 5**  
**36" ONLY \$154/case of 5**  
Above prices are for sign only.  
Optional flashing light  
additional at \$25 each.

### SAFETY POLES

Prevents Room Entry During Cleanup and Maintenance

ONE LOW PRICE –  
Order as many as you  
want **ONLY \$138/Case**  
(\$23/each)

Description	Item#	Color
Closed for Cleaning	9175	Fluorescent Green
Closed for Maintenance	9177	Fluorescent Green

Packed 6 per case (no broken cases).  
Extends 30" to 44" so as to fit most standard doors.



Please give us your email address so we can let you know of new products and monthly specials.

**NEW!**

# STAINLESS STEEL SHOWER CHAIRS/COMMODOES

**WILL NOT RUST!**



## C-SS-1200 Palladium Series \$795.00

The Palladium Series Stainless Steel Chair/Commode has quickly become our most popular model due to its unique dual dropping side arms. Designed for bariatric patients up to 1200 pounds and under. It can be used as a shower chair, bedside commode and an over-the-toilet commode. Comes standard with 4" Total Lock casters which when locked, provide a solid platform for the patient to get on and off with ease. Easy to clean. Available in white or black.

**Collection bucket included.**

### Dimensions

- 40" High x 22" Wide x 20" Deep
- 22" clearance between arm rests
- 1200 lb. capacity



## C-GS-700 Gold Series \$990.00

The Gold Series Stainless Steel Chair/Commode was designed for bariatric patients 700 pounds and under. It comes standard with 4" Total Lock casters which when locked, provide a solid platform for the patient to get on and off with ease. The stainless steel construction can meet any service condition and a custom trainable option is available.

**Collection bucket included.**

### Dimensions

- 36" High x 32" Wide x 21" Deep
- 29" clearance between arm rests
- 700 lb. capacity



Largest Shower Chair/Commode on the market today!

## C-PS-1000 Platinum Series \$1,500.00

The Platinum Series Stainless Steel Chair/Commode was designed for bariatric patients 1000 pounds and under. It comes standard with 4" Total Lock casters which when locked, provide a solid platform for the patient to get on and off with ease. The stainless steel construction can meet any service condition and a custom trainable option is available.

**Collection bucket included.** (not shown)

### Dimensions

- 36" High x 39" Wide x 21" Deep
- 36" clearance between arm rests
- 1000 lb. capacity

**SEE PAGES 84 AND 85 FOR MORE SHOWER CHAIRS AND COMMODOES** →

### FIVE EASY WAYS TO ORDER:

1. **By Mail:** P.O. Box 190 • Syosset, NY 11791
2. **Toll-Free:** 1-800-288-3547

3. **By Fax:** 1-516-367-4714
4. **By email:** LPCORP@aol.com

5. **Through our website:** www.LatestProducts.net



SINCE 1972, DISTRIBUTORS OF SPECIALTY ITEMS FOR HOSPITALS, NURSING HOMES, INSTITUTIONS

# LATEST PRODUCTS CORP.

P.O. Box 190 • Syosset, New York 11791 • 1-800-288-3547 • Fax 1-516-367-4714 • email LPCORP@aol.com

## PVC SHOWER CHAIRS/COMMODOES FULLY CUSTOMIZABLE TO MEET YOUR FACILITY'S SPECIFIC NEEDS!



**C-SCC700 includes collection bucket** **\$362.00**

- 38.5" H x 21.5" W x 20" D
- 17" clearance between arms.
- 300 lb. capacity.
- 17" clearance.
- Can be used as shower chair or commode chair.
- Deluxe open-front soft seat with pail.
- Deluxe matching soft backrest and waterproof seat.
- No-rust twin-wheel locking casters are standard.
- Available in (G) Gray, (N) Navy or (L) Laguna Green.



**C-SCC716 collection bucket not included** **\$294.00**

- 38" H x 21" W x 20" D
- 18" clearance between arms.
- 300 lb. capacity.
- 17" clearance.
- Can be used as shower chair or commode chair.
- Open-front no slip, soft seat for easy washing.
- Backrest is designed for real comfort and is available in multiple colors.
- No-rust twin-wheel locking casters are standard.
- Available in (G) Gray, (N) Navy or (L) Laguna Green.



**C-SCC767 includes collection bucket** **\$446.00**

- 41" H x 21" W x 20" D
- 18" clearance between arms.
- 300 lb. capacity.
- 20" clearance.
- Can be used as shower chair or commode chair.
- Left drop arm.
- Deluxe soft seat (open front available with pail).
- Mesh (Standard) or Deluxe backrest available.
- Slideout footrest with anti-tip design.
- No-rust twin-wheel locking casters are standard.
- Available in (G) Gray, (N) Navy or (L) Laguna Green.



**C-SC9111 includes slant seat feature and collection bucket** **\$215.00**

- 38" H x 21" W x 20" D
- 18" clearance between arms.
- 300 lb. capacity.
- 17" clearance.
- Can be used as shower chair or commode chair.
- No-rust twin-wheel locking casters are standard.
- Available in (G) Gray, (N) Navy or (L) Laguna Green.

### Slant Seat Feature:

This feature, available on all chairs, helps hold patients in position. The seat is lower in the back to prevent sliding forward. With this feature, many patients will stay in position without the use of restraints.



**C-SCC255** **\$378.00**

- 41" H x 21" W x 20" D
- 18" clearance between arms.
- 300 lb. capacity.
- **Made to accommodate bedpans.**
- Available in (G) Gray, (N) Navy or (L) Laguna Green.



### FIVE EASY WAYS TO ORDER:

1. **By Mail:** P.O. Box 190 • Syosset, NY 11791
2. **Toll-Free:** 1-800-288-3547

3. **By Fax:** 1-516-367-4714
4. **By email:** LPCORP@aol.com

5. **Through our website:** [www.LatestProducts.net](http://www.LatestProducts.net)



Used by  
Nursing Homes  
and Assisted  
Living Facilities

# PVC SHOWER CHAIRS/COMMODOES EXTRA CAPACITY & BARIATRIC MODELS



**C-SCC9250-OS**      \$305.00

- 40" H x 25" W x 25" D
- 22" clearance between arms.
- 350 lb. capacity.
- 19" clearance.
- Can be used as shower chair or commode chair.
- High quality PVC construction.
- 12 quart removable pail slides out from the side.
- Easy to clean with anti-tip design.
- 4" locking casters. 5" & 6" Deluxe casters available.
- Mesh backrest available in multiple colors\*.



**C-BS-C660**      \$970.00

- 39.5" H x 34" W x 27.5" D
- 28" clearance between arms.
- 700 lb. capacity.
- Can be used as shower chair or commode chair.
- Seat height 21".
- High density polyethylene flat seat.
- Elongated seat hole and pail.
- 6 heavy duty 5" casters (4 locking).
- Slideout footrests standard.
- Convenient push handles.
- Heavy-duty 1-1/2" pipe.
- Mesh backrest available in multiple colors\*.



**C-BS-C880**      \$1,295.00

- 40" H x 36" W x 31" D
- 30" clearance between arms.
- 900 lb. capacity.
- Can be used as shower chair or commode chair.
- Seat height 21".
- High density polyethylene flat seat.
- Large seat hole and pail.
- 6 heavy duty 5" casters (4 locking).
- Slideout footrests standard.
- Convenient push handles.
- Heavy-duty 1-1/2" pipe.
- Mesh backrest available in multiple colors\*.

\*Colors available: White, Navy Blue, Maroon, Silver, Forest Green, Teal, Plum.

## Options for All PVC Shower Chairs/Commodes



Deluxe Soft Seat



Open Front Deluxe Seat



Deluxe Split Seat



Privacy Skirt



Lap Bar



Seat Belt

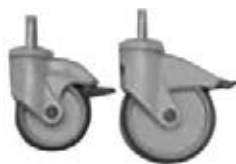

Multiple Caster Sizes



Slideout Footrest



Drop Arm

Please ask us about the other PVC products we offer, including patient gurneys and transport boards, restraint-free low beds, pillow carts, and more!



SINCE 1972, DISTRIBUTORS OF SPECIALTY ITEMS FOR HOSPITALS, NURSING HOMES, INSTITUTIONS

# LATEST PRODUCTS CORP.

P.O. Box 190 • Syosset, New York 11791 • 1-800-288-3547 • Fax 1-516-367-4714 • email LPCORP@aol.com

## STANDARD IV STAND

### Model 1000D Standard Stainless Steel IV Stand

**\$275.00 with 3" Deluxe Casters.**

We constructed our stainless steel pole with your heaviest duties in mind. They are stackable for tight storage areas and trainable for ease of multiple transport.

The stand's self-flushing design drains fluids, making it perfect for automated cleaning and decontaminating.

An MRI-compatible version is also available. Contact us for more details.

**CASTER SIZES:** 2-5" casters are available, ranging from standard to full-locking, maintenance-free deluxe options.

**WEIGHT:** 25-100 lb. weights are available to give additional stability.

**ACCESSORIES:** Available with up to twelve Bag Hooks. Also Patient Rings, Sharps Holders, Equipment Baskets, Shelves, Locking Drawers, Power Strips, O<sub>2</sub> Holders, and Stenciling are available.

***We're proud to say this is the finest IV Pole the market has to offer!***

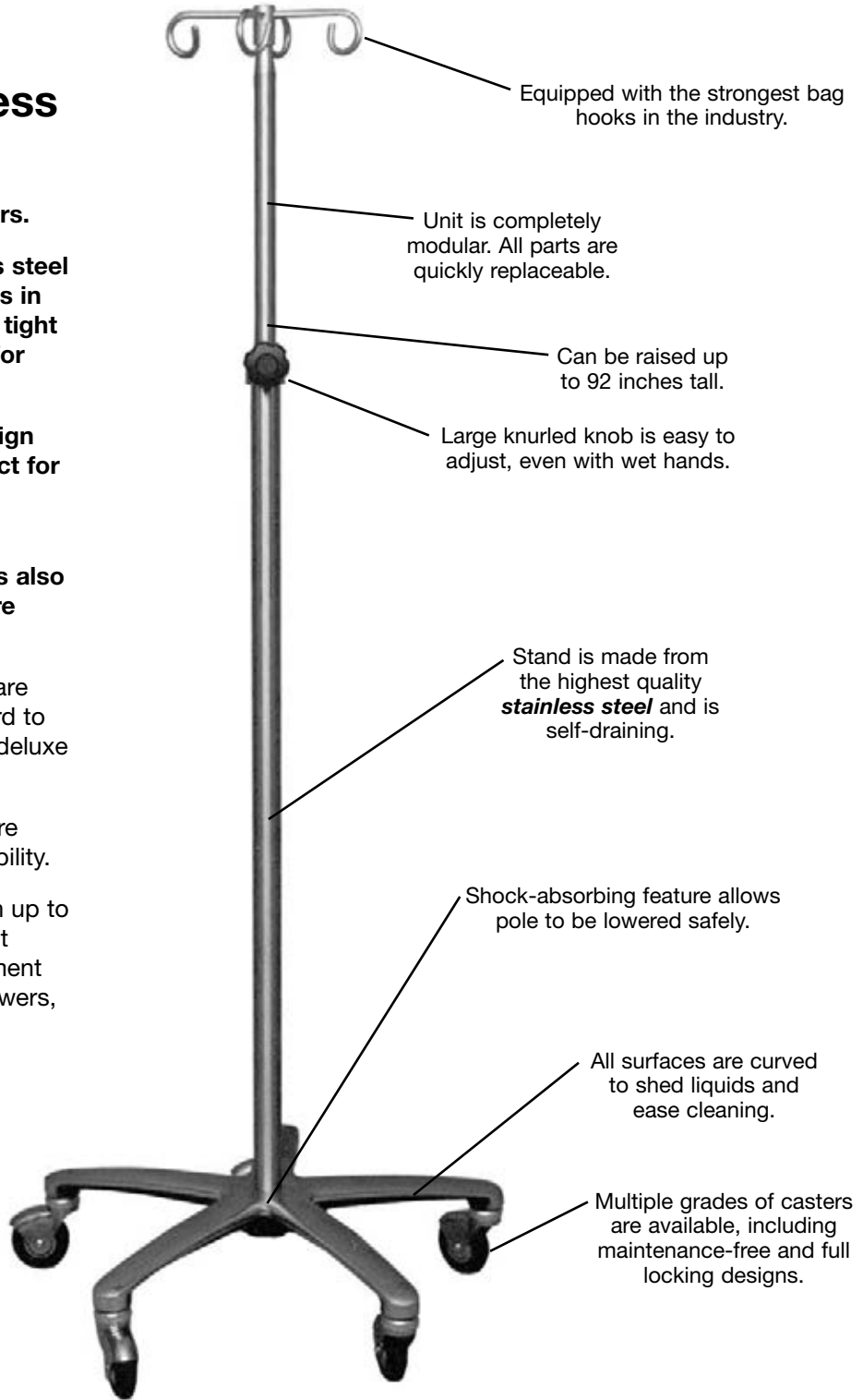

Equipped with the strongest bag hooks in the industry.

Unit is completely modular. All parts are quickly replaceable.

Can be raised up to 92 inches tall.

Large knurled knob is easy to adjust, even with wet hands.

Stand is made from the highest quality **stainless steel** and is self-draining.

Shock-absorbing feature allows pole to be lowered safely.

All surfaces are curved to shed liquids and ease cleaning.

Multiple grades of casters are available, including maintenance-free and full locking designs.

We are so confident these are the finest IV Poles on the market today, that we will send you one for a 30 day no obligation evaluation. If you are not satisfied, you can return the IV Pole in its original carton and we will invoice you for the original shipping costs only.

# SURGICAL OR IV STAND

## Model 1000D-OR Surgical OR IV Stainless Steel Stand

**\$315.00 with 3" Deluxe Casters and 25 lb. weight included.**

**We created this Surgical OR Stand to surpass the stringent standards that the operating room demands.**

**Its superior design provides the strength to support slung arms or legs in orthopedic procedures.**

**CASTER SIZES:** 2-5" casters are available, ranging from standard to full-locking, maintenance-free deluxe options.

**WEIGHT:** 25-100 lb. weights are available to give additional stability.

**ACCESSORIES:** Available with up to twelve Bag Hooks. Also Patient Rings, Sharps Holders, Equipment Baskets, Shelves, Locking Drawers, Power Strips, O<sub>2</sub> Holders, and Stenciling are available.

***This stand is stronger than any unit you've ever seen. We're proud to say this is the best stand the market has to offer!***

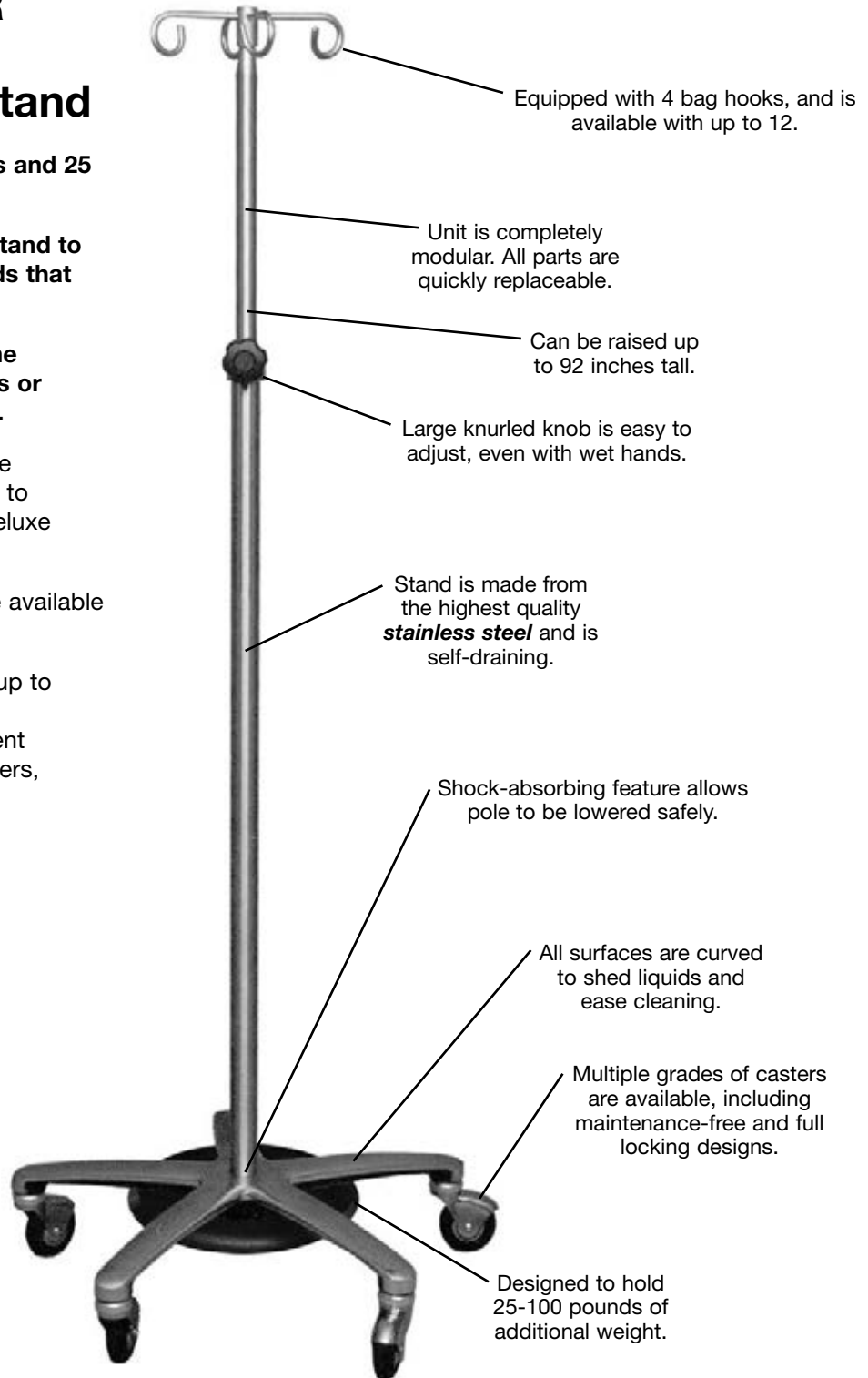

**We are so confident these are the finest IV Poles on the market today, that we will send you one for a 30 day no obligation evaluation. If you are not satisfied, you can return the IV Pole in its original carton and we will invoice you for the original shipping costs only.**



SINCE 1972, DISTRIBUTORS OF SPECIALTY ITEMS FOR HOSPITALS, NURSING HOMES, INSTITUTIONS

# LATEST PRODUCTS CORP.

P.O. Box 190 • Syosset, New York 11791 • 1-800-288-3547 • Fax 1-516-367-4714 • email LPCORP@aol.com

## 2000C IV STAND WITH POWERSTRIP

### Model 2000C Custom OR IV Stainless Steel Stand

**\$450.00 with 3" Deluxe Casters and 25 lb. weight included.**

**We created this Custom Stainless Steel Stand to surpass the stringent standards that today's hospitals demand.**

**Its superior design provides the strength and resilience that – even when loaded up with multiple pumps, bags and accessories – provides a stable platform that is effortless to work with.**

**CASTER SIZES:** 2-5" casters are available, ranging from standard to full-locking, maintenance-free deluxe options.

**WEIGHT:** 25-100 lb. weights are available to give additional stability.

**OPTIONAL ACCESSORIES:** Patient Rings, Sharps Holders, Equipment Baskets, Shelves, Locking Drawers, O<sub>2</sub> Holders, and Identification (color-coded illumination) and Identification Stenciling are available.

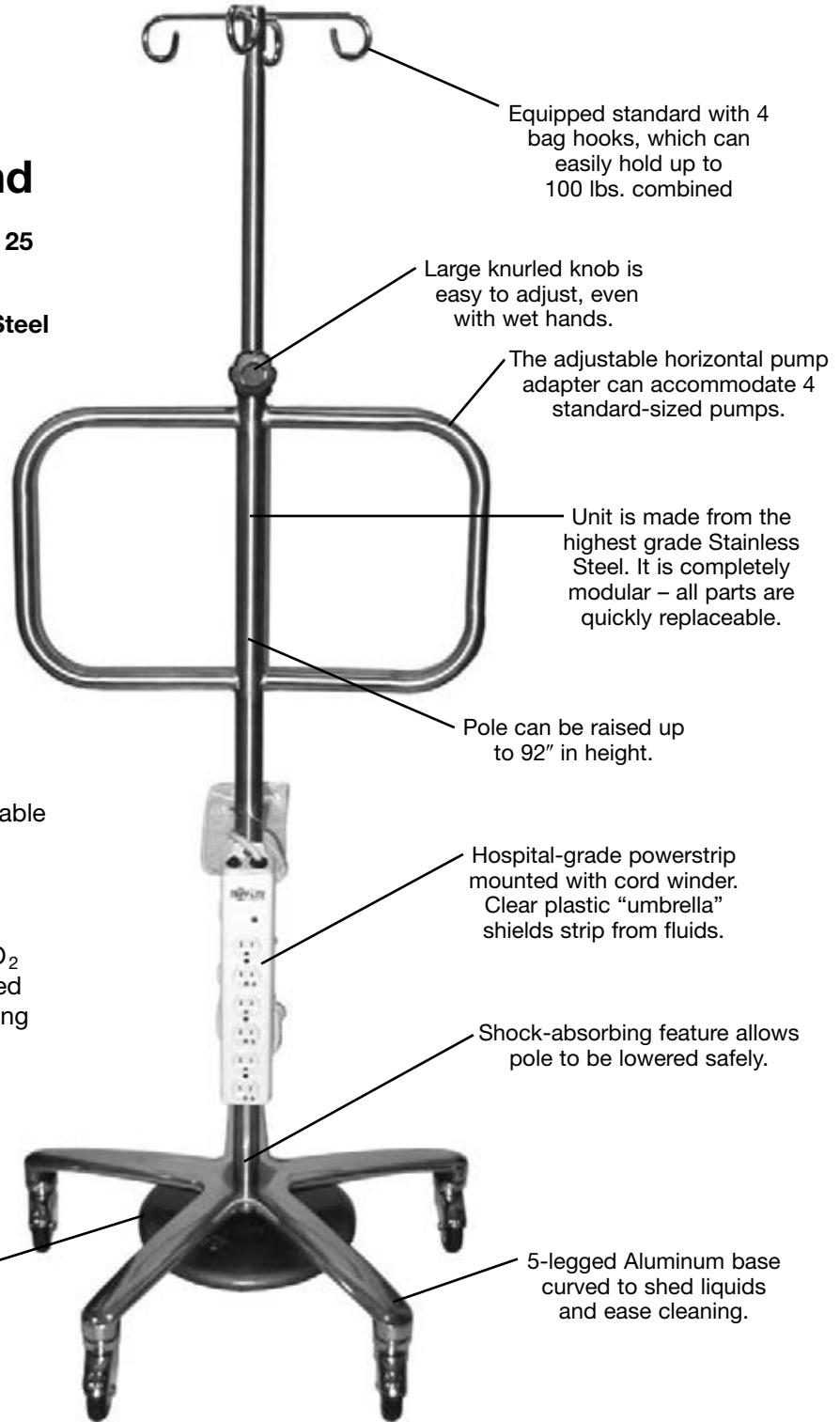

**We are so confident these are the finest IV Poles on the market today, that we will send you one for a 30 day no obligation evaluation. If you are not satisfied, you can return the IV Pole in its original carton and we will invoice you for the original shipping costs only.**

# STAINLESS STEEL CLOSED CASE CARTS

## Case Carts

The functional design of our Case Carts maximizes usable inside storage space and provides superior maneuverability. Carts can be used wherever contents must be protected from an “unclean” environment, including free-standing ambulatory care centers, surgi-centers and hospital based/outpatient surgeries.

**CASE-L24** — Cart is space efficient and can be used for minor surgery, labor and delivery and outpatient procedures. Low capacity with functional work surface.

**CASE-H24** — High profile cart saves floor space and minimizes bending. Medium capacity, small footprint.

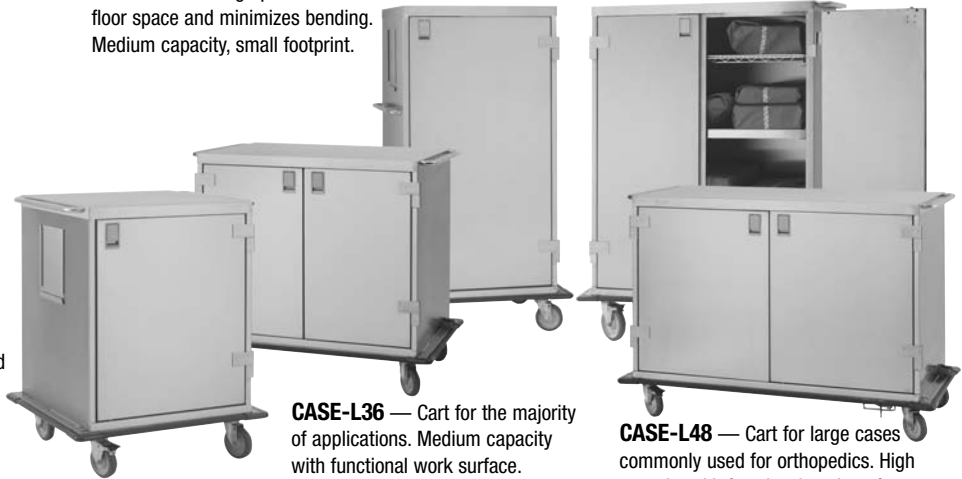

**CASE-L36** — Cart for the majority of applications. Medium capacity with functional work surface.

**CASE-H36** — Cart for large or multiple cases, commonly used for orthopedics. High capacity, moderate footprint.

**CASE-L48** — Cart for large cases commonly used for orthopedics. High capacity with functional work surface.

Width		Height		Approx. Pkd. Wt. (lbs.)	Cat. No. with Stainless Casters	Price Each	Cat. No. with Polymer Casters	Price Each
Overall (inches)	Cabinet (inches)	Overall (inches)	Cabinet (inches)					
32 <sup>7</sup> / <sub>8</sub>	27 <sup>1</sup> / <sub>2</sub>	38 <sup>7</sup> / <sub>8</sub>	32	115	CASE-L24*	\$1,840.00	CASE-L24P*	\$1,840.00
44 <sup>7</sup> / <sub>8</sub>	39 <sup>1</sup> / <sub>2</sub>	38 <sup>7</sup> / <sub>8</sub>	32	186	CASE-L36*	2,195.00	CASE-L36P*	2,195.00
56 <sup>7</sup> / <sub>8</sub>	51 <sup>1</sup> / <sub>2</sub>	38 <sup>7</sup> / <sub>8</sub>	32	212	CASE-L48*	2,400.00	CASE-L48P*	2,400.00
32 <sup>7</sup> / <sub>8</sub>	27 <sup>1</sup> / <sub>2</sub>	56 <sup>7</sup> / <sub>8</sub>	50	162	CASE-H24*	1,995.00	CASE-H24P*	1,995.00
44 <sup>7</sup> / <sub>8</sub>	39 <sup>1</sup> / <sub>2</sub>	57 <sup>7</sup> / <sub>8</sub>	50	215	CASE-H36*	2,600.00	CASE-H36P†	2,600.00

All units are 28<sup>1</sup>/<sub>2</sub>" deep overall. Cabinet depth is 25<sup>7</sup>/<sub>8</sub>".

\*Order shelves separately.

†CASE-H36P includes 6" diameter casters. All other carts include 5" diameter casters.

## Optional Shelves (Wire Pullout, Wire Pullout with Rollers, Solid)

Cart	Shelf Size (inches)	Approx. Pkd. Wt. (with 2 brackets)		Price Each	Approx. Pkd. Wt. (with 2 brackets)		Price Each	Approx. Pkd. Wt. (with 2 brackets)		Price Each
		(lbs.)	Cat. No. Wire Shelf		(lbs.)	Cat. No. Roller Shelf		(lbs.)	Cat. No. Solid Shelf	
CASE-L24P	24 x 24	9	CCWS-24	\$145.00	12	CCROLWS-24	\$170.00	15	CCSS-24	\$155.00
CASE-L36P	24 x 36	13	CCWS-36	165.00	16	CCROLWS-36	190.00	19	CCSS-36	175.00
CASE-L48P	24 x 48	19	CCWS-48	200.00	21	CCROLWS-48	225.00	25	CCSS-48	210.00
CASE-H24P	24 x 24	9	CCWS-24	145.00	12	CCROLWS-24	170.00	15	CCSS-24	155.00

Each shelf includes two attachment brackets.

Shelf weight capacity is 150 lbs. evenly distributed.



Optional wire roller shelf, pulls out halfway, easily and quietly, even at the bottom level where accessibility is vital.



Ergonomic full length handles (on both sides of the low-profile carts) allow for convenience in pushing or pulling from either end and provide better cart control.



Detachable brackets remove for faster and easier cleaning and drying. Brackets, which hold shelves, attach and detach quickly from “keyhole” slots for easy shelf adjustability at 2" increments.



Double panel door provides optimum strength. Recessed latch eliminates a catch point. Two-door models have a center flange to stop splashes from entering cart.



Stainless Steel Caster Specially designed stainless steel casters provide easy maneuverability even through frequent cart washings. It features long wearing, shock absorbing, polyurethane tread.



Polymer Caster Provides the same weight load capacity and is equipped with the same long-wearing polyurethane tread. Not recommended if carts are washed frequently.

**Note:** Two swivel casters and two swivel casters with brake are standard on the 24" and 36" length models. The 48" model comes standard with one brake, one swivel-lock and two swivel casters. Brakes and swivel locks are conveniently located to be activated.

Please share our catalog with other departments throughout your facility who may be interested in our products. We would be happy to send another catalog upon request.





SINCE 1972, DISTRIBUTORS OF SPECIALTY ITEMS FOR HOSPITALS, NURSING HOMES, INSTITUTIONS

# LATEST PRODUCTS CORP.

P.O. Box 190 • Syosset, New York 11791 • 1-800-288-3547 • Fax 1-516-367-4714 • email LPCORP@aol.com

## CHROME SUTURE CARTS AND STERILE WRAP RACK CARTS

### Suture Carts

Slanted shelves present contents for instant identification and access. Allows logical organization, eliminates confusion, makes ordering easy.

Width/Length (inches)	Height (inches)	Description	Approx. Pkd. Wt. (lbs.)	Catalog Number	Price Each
18 x 24	60	One Flat and Four Slanted Shelves	105	DC15EC	\$555.00
18 x 24	60	Five Slanted Shelves	113	DC16EC	575.00
18 x 36	60	One Flat and Four Slanted Shelves	98	DC35EC	590.00
18 x 36	70	Five Slanted Shelves	100	DC36EC	615.00
18 x 48	60	One Flat and Four Slanted Shelves	115	DC55EC	625.00
18 x 48	70	Five Slanted Shelves	118	DC56EC	650.00

Note: All Suture Carts include package of 12 retainers.

Note: Shelves slant at a 45° angle or 9° from front to back.



DC56EC



DC16EC

### Additional Wire Shelves

Width/Length (inches)	Approx. Pkd. Wt. (lbs.)	Catalog Number	Price Each
18 x 24	10.5	1824DNC	\$55.00
18 x 36	14.5	1836DNC	65.00
18 x 48	18.5	1848DNC	70.00

### Additional Retainers

Length (inches)	Height (inches)	Approx. Pkd. Wt. per 12 pieces (lbs.)	Catalog Number	Price Each
17	4	1	DCR17C	\$10.00

### Low-Profile Sterile Wrap Rack

Provides a safe, convenient place to hold wrap. Most sizes can be displayed prominently so that they are easy to locate. One sheet, or several sheets at a time, can be removed quickly and neatly. The wire bottom shelf can be used to hold extra wrap, or less frequently used sizes. Support bars hold wraps up to 60" x 60". Rubber "O" rings deter sliding of wraps.

Width/Length (inches)	Height (inches)	Approx. Pkd. Wt. (lbs.)	Catalog Number	Price Each
18 x 63	39½	61	WSA-WR	\$560.00

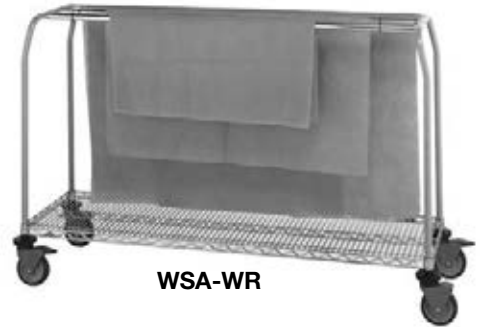

WSA-WR

### High-Profile Sterile Wrap Rack

Designed to provide a safe, convenient area to hold wrap. One sheet or several sheets can be removed quickly and neatly. Bottom shelf may be used to hold extra wrap or less frequently used sizes.

Shelf Width (inches)	Shelf Length (inches)	Overall Height (inches)	Bottom Shelf Material	Frame Material	Post Material	Approx. Pkd. Wt. (lbs.)	Catalog Number	Price Each
24	48	68	Chrome	Chrome	Chrome	83.1	SWR556DC	\$645.00
24	60	68	Chrome	Chrome	Chrome	94.3	SWR566DC	695.00

Note: Special length posts are available. Cart Covers available. See pages 10-11.

### Additional Support Bars (For High-Profile Rack)

Length (inches)	Catalog Number	Price Each
48	SWRB5S	\$40.00
60	SWRB6S	45.00



SWR566DC

We gladly accept Mastercard, Visa and American Express.

# METAL RECYCLING CONTAINERS

Three: Color Choices  
Lid Options  
Convenient Sizes



GeoCubes

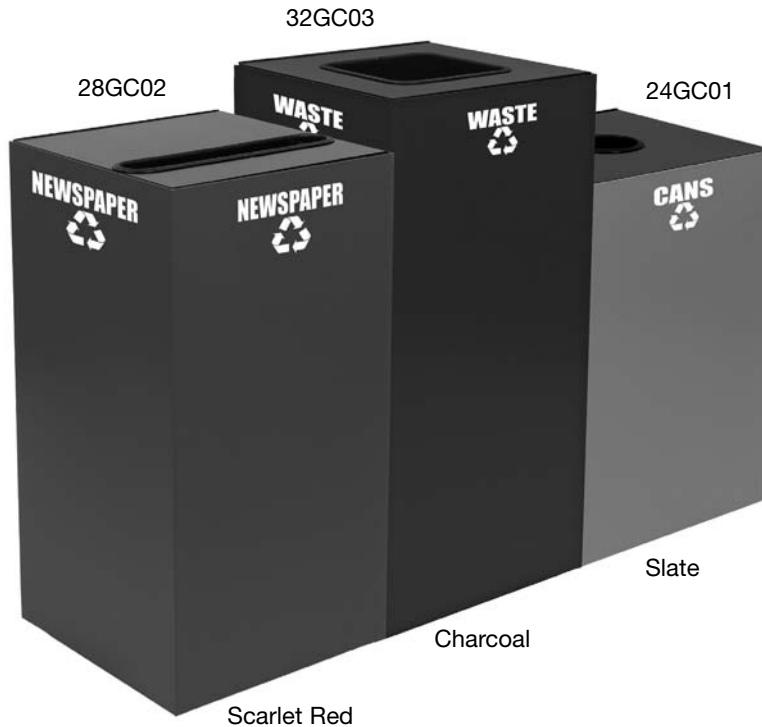

**RECYCLE**

## Recycling Containers

Helpful in separating waste from recyclables in public areas

- Space efficient receptacle for recycling
- Mix and match GeoCube for unique combinations
- Compact and firesafe steel construction
- Sort recyclables easily
- Attractive, functional choice for hospitals, nursing homes, correctional facilities, municipalities or as part of any organizations' recycling program
- Each lid comes with one each of the following decals:  
Round Opening: "Cans" and "Bottles"  
Slot Opening: "Paper" and "Newspaper"  
Square Opening: "Waste" and "Plastic"



GeoCubes Lid Options

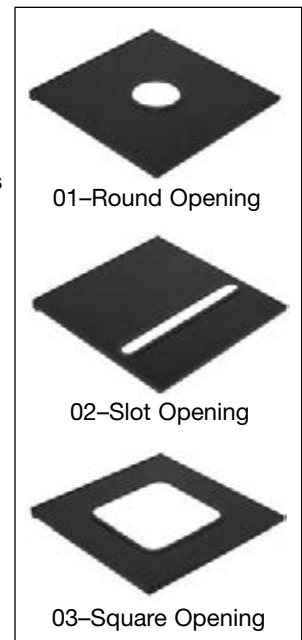

Item Number	Description	Capacity	Dimensions	Weight	Lid Options	Colors	Price
24GC	Geo cube recycling unit	24 gal.	15" x 15" x 24"	24 lbs.	01, 02, 03	SC, CB, SL	\$155
28GC	Geo cube recycling unit	28 gal.	15" x 15" x 28"	27 lbs.	01, 02, 03	SC, CB, SL	\$165
32GC	Geo cube recycling unit	32 gal.	15" x 15" x 32"	31 lbs.	01, 02, 03	SC, CB, SL	\$180

Colors: SC—Scarlet Red, CB—Charcoal, SL—Slate

Additional decals are \$8 each.

**TERMS: 2% ten days, net 30, F.O.B. Factory. We prepay shipping and add to invoice.**



SINCE 1972, DISTRIBUTORS OF SPECIALTY ITEMS FOR HOSPITALS, NURSING HOMES, INSTITUTIONS

# LATEST PRODUCTS CORP.

P.O. Box 190 • Syosset, New York 11791 • 1-800-288-3547 • Fax 1-516-367-4714 • email LPCORP@aol.com

## SECURE DOCUMENT CONTAINERS

Latest Products Corporation is pleased to announce our new **SECURE DOCUMENT CONTAINERS** are now in stock and available for shipping! If your organization is required to comply with the **Health Insurance Portability and Accountability Act (HIPAA)** or the **Fair and Accurate Credit Transactions Act (FACTA)**, our secure document containers are just what you need! All models are fire-safe and designed to keep documents completely confidential until disposal.

### Secure Document Containers are Ideal for Use In:

**Hospitals • Nursing Homes • Assisted Living Facilities • Correctional Facilities • Universities  
Government Facilities • VA Hospitals • General Industry**

**WHEREVER SECURITY OF CONFIDENTIAL DOCUMENTS IS CRITICAL**

We are offering two series of containers:

#### Our **PLATINUM** series:

- 36 gallon capacity with vinyl drawstring bag as standard equipment
- Includes lock and 2 keys
- Flat top with front-door opening
- Made of fire-safe metal and available in 3 colors (light gray, putty, charcoal)
- 18" x 20" x 31", weighs 35 lbs.

#### Our **MODIFIED** series:

- Available in three capacities—24, 28 or 32 gallon
- Includes lock and 2 keys
- Top-opening
- Made of fire safe metal and available in 3 colors (light gray, putty, charcoal)
- 15" x 15" with height of 24" for 24 gallon, 28" for 28 gallon or 32" for 32 gallon



**36PSS**



**Model #36PSS  
PLATINUM SERIES \$229 each**

**28MSR**



**24MSR**



**32MSR**



#### **MODIFIED SERIES**

- |           |                           |
|-----------|---------------------------|
| 24 gallon | \$160 each (Model #24MSR) |
| 28 gallon | \$179 each (Model #28MSR) |
| 32 gallon | \$189 each (Model #32MSR) |



**Don't risk confidential information ending up in the wrong hands!**

# ISOLATION CARTS & ACCESSORIES

All PVC Carts  
Fully Customizable  
Can be Made  
MRI Compatible  
Manufactured in USA

## 3-DRAWER PVC ISOLATION CART ST-33

This PVC cart is an economical way to store all of your Isolation Unit needs. Each drawer measures 7"H x 19"W x 14"D. Functional top work surface measures 26"L x 15"D. Floating backboard can accommodate various accessories (not included). Sides and back of cart encased with yellow woven mesh material to designate isolation needs. Comes with 4" casters standard. Dimensions: 45"H x 26"W x 15"D  
Price: \$329



## ISOLATION GOWN STORAGE CART C-ISO-4001

This PVC cart is perfect for under counter use or tight spaces. It is available with or without lid. Comes with 3" deluxe "silent" carpet master casters. Yellow woven mesh standard—other fabrics/colors available. Front screen printing available to meet your specific needs. Holds approximately 75 gowns. Dimensions: 32"H x 21"W x 18.5"D  
Price: Without Lid \$209  
With Lid (model C-ISO-4001L) \$229



## ISOLATION GOWN COLLECTION CART C-LH21D-YELLOW-ISO

Our Isolation Gown Collection Cart comes standard with a yellow woven mesh zipper-front bag. It is designed to work with 39 gallon plastic or reusable leakproof bags. Zipper-front closure allows for easy release and removal of bag. Lid and foot pedals are standard. Comes with 3" locking deluxe TENTE casters. Dimensions: 37"H x 18"W x 18"D  
Price: \$210



## 3-DRAWER ISOLATION CART C-3923C

Our 3 drawer cart comes standard with 5" casters, all swivel with 2 locking casters. Push handle drawers, with built-in full-length pulls and hasp lock system. Yellow powder-coated steel is strong and will last for years to come. Accessories available. Dimensions: 45"H x 20"D x 31"W  
Price: \$1250

## 4-DRAWER ISOLATION CART C-MKS-430S

This cart comes with center-pull drawer handles and comes with key lock system. Yellow powder coated steel body with wrap-around bumpers. Cart shown with optional accessories—heavy-duty railing (TRS-2), coat rack (TCR-1), and utility hooks (TUH-1). 5" casters included. Dimensions: 46 1/2"H x 25"D x 32"W with 30" drawer space.  
Cart Price: \$1049  
Accessory Package \$179



## GLOVEBOX HOLDERS

Design your own Single, Double, or Triple glove box holder. Units can be mounted to walls or to carts (hardware included). Made of VIVAK transparent polycarbonate—offers superior strength and durability over acrylic!  
C-GB-01 Single Glove Box Holder \$40  
C-GB-02 Double Glove Box Holder \$62  
C-GB-03 Triple Glove Box Holder \$65

Additional Steel & Aluminum Carts Available Please inquire



### FIVE EASY WAYS TO ORDER:

1. By Mail: P.O. Box 190 • Syosset, NY 11791
2. Toll-Free: 1-800-288-3547

3. By Fax: 1-516-367-4714
4. By email: LPCORP@aol.com

5. Through our website: www.LatestProducts.net



SINCE 1972, DISTRIBUTORS OF SPECIALTY ITEMS FOR HOSPITALS, NURSING HOMES, INSTITUTIONS

# LATEST PRODUCTS CORP.

P.O. Box 190 • Syosset, New York 11791 • 1-800-288-3547 • Fax 1-516-367-4714 • email LPCORP@aol.com

## PVC PILLOW STORAGE AND TRANSPORT CART

Our C-PC-4000 cart was designed to store and transport pillows in a convenient fashion. This versatile product can hold up to 13 hospital-type pillows.

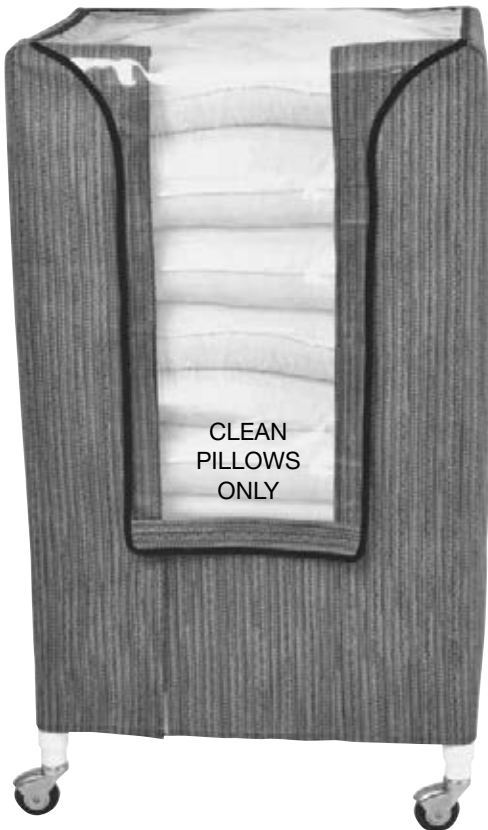

Features of this cart include:

- 3" Deluxe locking carpet master casters for easy transport on varied surfaces
- Clear protective vinyl front flap allows for quick inventory check and can flip up for easy loading and unloading
- Vinyl flap keeps contents clean and fresh
- Hospital-grade, easy to clean fabric meets California fire code regulations
- Available in 5 neutral aesthetically pleasing fabrics as well as bright yellow and our red, white and blue "Victory" line (popular with VA Hospitals)
- Dimensions of 48"H x 38"W x 21"D can hold up to 13 hospital pillows
- Fully customizable for larger or smaller capacity needs
- Optional cart identification label/lettering included
- Cart can be used for items other than pillows, such as linens, towels, blankets, isolation gowns, etc.

C-PC-4000 Model shown with "Durango" Cart Cover  
\$449 per cart

**Custom Units Available!**

**ALL PVC CARTS PROUDLY MADE IN THE U.S.A.**



Please share our catalog with other departments throughout your facility who may be interested in our products. We would be happy to send another catalog upon request.



# LATEST PRODUCTS CORP.

www.LatestProducts.net 1-800-288-3547

## Five Easy Ways To Order!



Mail this order form & or your purchase order:

Latest Products Corp.  
P.O. Box 190  
Syosset, NY 11791

Written purchase orders are preferred.  
Your order is processed immediately upon receipt.



Call us toll-free at:  
**1-800-288-3547**  
Office hours:  
Monday - Friday  
8 am - 5 pm (EST)



Fax us at:  
**1-516-367-4714**



E-mail us at:  
**LPCORP@aol.com**



Through Our Website at:  
**www.LatestProducts.net**

Quantity	Model Number	Description	Page Number	Color	Unit Price	Total Price

**NO RETURNS PERMITTED WITHOUT PRIOR AUTHORIZATION.**  
All returns are subject to a 25% handling and restocking charge plus freight charges incurred.

Sub Total

New York: add appropriate sale tax.  
*(If you are tax exempt, please include your tax exempt number & certificate.)*

Shipping & Handling

\*Shipping & handling charges are prepaid by LPC and are added to your invoice.

TBD\*

TOTAL

Terms: 2% 10 days; net 30 days.

Prices in this catalog are subject to change in the event of price increases from manufacturers.



WE GLADLY ACCEPT VISA, MASTERCARD AND AMERICAN EXPRESS.

### Method of Payment:

Purchase Order Number: \_\_\_\_\_

PAYMENT ENCLOSED (OR) PLEASE CHARGE MY:  Visa  Mastercard  American Express

Account #: \_\_\_\_\_ Expiration Date: \_\_\_\_\_ Security Code: \_\_\_\_\_

3 digits on back of Visa & MasterCard.  
4 digits on front of American Express.

Signature: \_\_\_\_\_

### Please Ship My Order To:

Company/Institution: \_\_\_\_\_ Attention: \_\_\_\_\_

Phone: \_\_\_\_\_ Extension: \_\_\_\_\_ E-mail: \_\_\_\_\_

Shipping Address (no P.O. Boxes):  Shipping Address and Billing Address are the same.

\_\_\_\_\_

Billing Address (if shipping and billing address is different):

\_\_\_\_\_

Please send additional catalogs to:

\_\_\_\_\_  
\_\_\_\_\_  
\_\_\_\_\_

Thank you for your order!

Find us on Facebook!

Follow us on Twitter!



## Our Satisfied Customers Say...

"I was one of Latest Product's first customers way back in 1972. I was satisfied then, and am a satisfied customer now, 40 years later!"

-B.W., New York, NY

"During these days of budget cut backs, we can always count on Latest Products to save us money. Enclosed is our newest order for hamperstands, laundry bags and linen carts."

-J.P., Atlanta, GA

"No company provides better customer service than LP! I have recommended your products to other departments and they are just as pleased. You Are The Best!"

-A.J., San Diego, CA

"We had a surprise Joint Commission inspection last year. We needed cart covers & laundry bags in a hurry. As always, L.P. came through and on very short notice. Thank you L.P."

-R.S., Milwaukee, WI



P.O. BOX 190  
SYOSSET, NEW YORK 11791  
FAX: 516-367-4714  
E-MAIL: [LPCORP@AOL.COM](mailto:LPCORP@AOL.COM)  
**1-800-288-3547**



Prices current as of 2011. In event of continued increase in raw materials prices are subject to change.



*We are your complete source for...*

- Laundry Bags
- Net Bags
- Cart Covers
- Hamperstands
- Heat Sealing Machines
- Pillows
- Utility Carts
- Indoor & Outdoor Trash Receptacles
- Garment Racks
- Shelving Units
- Dolly Carts
- Laundry Scales
- Stainless Steel Tables
- Stainless Steel Carts
- Security Carts
- Heat Dye Transfers & Emblems
- Privacy Screens
- PVC Carts
- Recycling Containers
- Housekeeping Carts
- Dunnage Racks
- Dump Trucks

*and other hard-to-find items!*

